



Safety Equipment

Catalogue

Valid from October 2023

DEHN protects.

www.dehn-international.com



Solutions for safe working on electrical installations



Safe when it matters most

Protect people and systems from electrical accidents. You can mitigate the risks posed by arc faults with the help of a comprehensive protection concept.

You will find an overview on our **website**.



Go to comprehensive arc fault protection website:

<http://de.hn/2wntv>



DEHNcare - in touch with people

The solution portfolio includes protective clothing for employees working on electrical installations. You will find arc-fault-tested protective clothing of the arc fault protection classes APC 1 and APC 2 as well as various risk classes (up to HRC 4) according to NFPA 70E here in the catalogue **from page 111**.



Go to personal protective equipment website:

<http://de.hn/b3Eaa>



Safe handling of high-voltage installations

The solution portfolio includes protective equipment for safe working on high-voltage installations such as charging posts, e-vehicles, bus charging stations, etc.

You can find an overview on our **website**.



Go to safe working in electric mobility website:

<http://de.hn/8MtpD>



Safe working on electric railways

The portfolio of solutions for safe working specifically for railway applications has been further enhanced.

Products for rail customers can be found here in a special chapter of this catalogue **from page 151** and on the **website**.



Go to website on protection of people and systems in the rail environment:

<http://de.hn/aThFc>

Content

Foreword	Page 3
Services	Page 9
DEHNarX - Risk assessment	Page 12
DEHNproX - Safe working on electric systems	Page 19
DEHNproX - Live working	Page 103
DEHNcare - Personal protective equipment	Page 111
DEHNshort - Arc fault protection system	Page 145
Safe working on electric railways	Page 151
Directories	Page 173





DEHN

Safe when it matters most

Comprehensive arc fault protection concept

Every company has an obligation under occupational health and safety legislation to protect its employees from possible accidents.

Step-by-step to your protection concept

Analyse the work situations for your electrical installations. Use the

- arc fault risk check list
- the "Let's check!" online seminar
- and the dialogue guideline

to assess and optimise arc fault protection measures.

Go to comprehensive
arc fault protection



DEHN protects.

www.dehn-international.com



DEHN protects.

Dear business associates,

For more than 110 years, the family-owned company DEHN SE has stood for safety and pioneering spirit in the fields of lightning protection, surge protection and safety equipment. With great passion and commitment, our employees develop safe and effective protection solutions and components for key issues of this day and age. Such as the expansion of renewable energy, e-mobility and its entire infrastructure, and the protection of those who work in these newly emerging ecosystems. Since 1952, the "DEHN Safety Equipment" range of products and services has centred around safe work on electrical installations.

- Due to the steady expansion of electric mobility, high-voltage (HV) systems are becoming increasingly common in vehicles of all kinds. New working conditions due to the use of e-vehicles or charging stations can lead to electrical hazards. Some of these dangers are new and need to be assessed in order to protect your own employees and external service personnel.
- **DEHNarX** supports industrial companies and manufacturers with the **risk assessment**. **By assessing the risks when working on electrical installations, suitable protective measures**, especially correct selection and provision of appropriate protective equipment, can be defined.
- **Railways** stand for climate-friendly mobility. Safety and availability are essential assets in this area. This applies to the planning of new systems as well as to maintenance and repair. You can find the requisite safety devices in a separate chapter of this catalogue.

- Technical measures such as the **DEHNshort** arc fault protection system protect people and optimise the availability of the energy supply. The use of these protection systems is established with all renowned manufacturers of low-voltage switchgear assemblies and long since regarded as state of the art.
- **Modern, comfortable and well-fitting protective equipment** is essential for both the safety and motivation of your employees when working on electrical installations. This is the reason why we are constantly optimising our **DEHNcare range** of protective clothing against the effects of arc faults. For jobs where high arc fault energies are to be expected, the new DEHNcare ArcFit High Level Protection (HLP) offers PPE 4 category protection according to NFPA 70E.

Benefit from our more than 70-year experience in electrical safety. In this catalogue you will find all the necessary measures and means of protection, e.g. to develop a **comprehensive protection concept against arc faults**. **The TOP principle from the German Occupational Health and Safety Act** provides orientation when defining protection measures.

Develop a protection concept for electrical risk situations in your company step by step. This keeps your employees safe when it matters most.

I appreciate your interest and the opportunity to work with you!

Dr. Philipp Dehn, Chairman of the Board (CEO)



Safe work on high-voltage transmission lines.
Voltage tester PHE4 high voltage can be found on page 35.

On the following pages, you will find basic information which helps you find your way around the DEHN Safety Equipment catalogue and presents important additional information on the product in a structured way.

In the 1st part you will find all relevant standards and in the 2nd part practical additional information.

Detailed structure of the DEHN informative pages:

STANDARDS

1. Standards for tools, equipment, protective and auxiliary equipment
2. Standards and test principles for personal protective equipment
3. Standards for active protection against arc faults
4. Provisions for periodic inspections

PRACTICAL Additional Information

5. Short descriptions
 - 5.1 Materials
 - 5.2 Surface treatment
 - 5.3 Conductor types
6. Minimum lengths of insulating elements
7. Explanation of symbols

STANDARDS

1. Standards for tools, equipment, protective and auxiliary equipment

DIN VDE 0680

Personal protective equipment, protective equipment and devices for working on live parts up to 1000 V

Part 1	Insulating protective devices
Part 4	NH fuse puller
Part 7	Fuse handles for low-tension HRC-fuses

DIN VDE V 0681

Operating, testing and safeguarding devices for work on electrically energized systems with rated voltages exceeding 1 kV

Part 1	General specifications for DIN VDE V 0681 Part 2-3
Part 2	Switching sticks
Part 3	Fuse tongs
Part 6	Voltage detectors for the overhead contact line systems of electric railways (DIN VDE 0681-6)

DIN VDE 0682

Devices and equipment for working on live parts

Part 201	Live working - Hand tools for use up to 1000 V AC and 1500 V DC (IEC/EN 60900)
Part 211	Live working - Insulating sticks and interchangeable operating heads - Part 1: Insulating sticks
Part 212	Live working - Insulating sticks and interchangeable operating heads - Part 2: Interchangeable operating heads
Part 213	Multipurpose insulating sticks for electrical operations in high-voltage installations (EN 50508)
Part 401	Two-pole voltage detector for low-voltage system (IEC/EN 61243-3)

Part 411	Voltage detector, capacitive type for voltages exceeding 1 kV AC (IEC/EN 61243-1)
Part 412	Voltage detector, resistive (ohmic) type for voltages of 1 kV to 36 kV AC (IEC/EN 61243-2)
Part 415	Voltage detecting systems (IEC/EN 61243-5)
Part 417	Voltage detectors, distance voltage detectors (preliminary standard DIN VDE 0682-417)
Part 421	Voltage detectors, capacitive type for voltages exceeding 1 kV AC and a frequency of 16.7 Hz (preliminary standard DIN VDE V 0682-421)
Part 431	Part 1: Phase comparator Capacitive type for voltages exceeding 1 kV AC (IEC/EN 61481-1)
Part 431	Part 2: Phase comparator Resistive (ohmic) type for voltages exceeding 1 kV to 36 kV AC (IEC/EN 61481-2)
Part 511	Electrically insulating blankets (IEC/EN 61112)
Part 512	Electrically insulating mats (IEC/EN 61111)
Part 552	Insulating protective shutters over 1kV
Part 603	Telescopic sticks and telescopic measuring sticks (IEC/EN 62193)
Part 621	Equipment for suction cleaning of live parts with a rated voltage from 1 kV to 36 kV

DIN VDE 0683

Portable equipment for earthing or earthing and short-circuiting

Part 100	Portable equipment for earthing or earthing and short-circuiting (IEC/EN 61230)
Part 200	Earthing or earthing and short-circuiting equipment using lances as a short-circuiting device - Lance earthing (IEC/EN 61219)

2. Standards and test principles for personal protective equipment

EN ISO 13688	Protective clothing - General requirements
EN ISO 21420	Protective gloves - General requirements and test methods
EN 61482-1-1	Protective clothing against the thermal hazards of an electric arc - Part 1-1: Test methods - Method 1: Determination of the arc rating (ELIM, ATPV and/or EBT) of clothing materials and of protective clothing using an open arc
EN 61482-1-2	Protective clothing against the thermal hazards of an electric arc - Part 1-2: Test methods - Method 2: Determination of arc protection class of material and clothing by using a constrained and directed arc (box test)
EN ISO 11611	Protective clothing for welding and related processes
EN ISO 11612	Clothing to protect against heat and flame - Minimum performance requirements
EN ISO 14116	Protective clothing - Protection against flame - Limited flame spread materials, material assemblies and clothing
EN 1149	Protective clothing - Electrostatic properties
EN 17353	Protective clothing - Enhanced visibility equipment for medium risk situations - Test methods and requirements
EN ISO 20471+A1	High-visibility clothing - Test methods and requirements
EN 13034+A1	Protective clothing against liquid chemicals - Performance requirements for chemical protective clothing offering limited protective performance against liquid chemicals (type 6 and type PB [6] equipment)
EN 388+A1	Protective gloves against mechanical risks
EN 407	Protective gloves and other hand protection equipment against thermal risks (heat and/or fire)
GS-ET 42-2	Additional requirements for the testing and certification of heat-protective gloves for protection against the thermal effects of an arc fault
EN 166	Personal eye protection - Specifications

EN 170	Personal eye protection - Ultraviolet filters - Transmittance requirements and recommended use
GS-ET 29	Principles of testing and certification of face shields for electrical work
EN 60903	Live working - gloves of insulating material
EN 50365	Electrically insulating helmets for use on low voltage installations
EN ISO 20345	Personal protective equipment - Safety footwear
GS-IFA-P15	Test principles for the testing and certification of personal protective equipment (PPE) according to EC Directive 89/686/EEC - Protective clothing against high-pressure water jets
ASTM F1959	Standard Test Method for Determining the Arc Rating of Materials for Clothing
ASTM F2178	Standard Specification for Arc Rated Eye or Face Protective Products
ASTM F2675	Standard Test Method for Determining Arc Ratings of Hand Protective Products Developed and Used for Electrical Arc Flash Protection

3. Standards for active protection against arc faults

EN IEC 60947-9-1	Low-voltage switchgear and controlgear - Active arc-fault mitigation systems - Part 9-1: Arc quenching devices
EN IEC 60947-9-2	Low-voltage switchgear and controlgear - Active arc-fault mitigation systems - Part 9-2: Optical-based internal arc-detection and mitigation devices
IEC 60363-4-42	Low-voltage electrical installations - Part 4-42: Protection for safety - Protection against thermal effects
IEC TS 63107	Integration of internal arc-fault mitigation systems in power switchgear and controlgear assemblies (PSC-Assemblies) according to IEC 61439-2
EN 61439-2, Suppl. 1	Low-voltage switchgear and controlgear assemblies - Part 2: Power switchgear and controlgear assemblies; Supplement 1: Guide for testing under conditions of arcing due to internal fault (IEC/TR 61641)

4. Provisions for periodic inspections



Criteria for maintenance tests			
	German Social Accident Insurance (DGUV) Regulation 3 (formerly accident prevention regulations (BGV A3))	EN 50110-1 (DIN VDE 0105-100)	Equipment standard
Earthing and short-circuiting devices	§ 5 (1) [... equipment is to be checked for proper condition ...] (2) [... at specific intervals. The intervals shall be selected such that defects which are to be anticipated are detected in good time!]	4.6, Note 1 [Maintained in a condition suitable for use means periodic visual inspections and electrical testing where necessary. (for example via working aids of the BG ETEM professional association for visual inspection during everyday work (1))] 5.5 [Periodic Inspection]	EN 61230 Annex C (informative) C.3.2.2 [It is recommended to perform an inspection at least every five years in case of outdoor use and every ten years in case of indoor use.] DIN EN 61230 supplement 1, paragraph 4.2 Maintenance inspections [Regular inspection using a non-destructive, multi-stage method (LoRe measurement method) that detects possible internal cable damage without destroying the EaS device (2)].
Voltage detectors, phase comparators and voltage detecting systems	§ 5: Table 1C [Tests for compliance with the limit values specified in the electrotechnical rules must be carried out at least every six years]	6.2.4.1 [Test shall be proved immediately before and where possible after use] 5.5 [Periodic Inspection]	DIN EN 61243-1 Appendix G (informative) Tests for capacitive testers > 1 kV [No voltage tester should be used that has not been retested for 6 years.] DIN EN 61243-5 Description of tests for voltage detecting system (VDS) DIN EN 61481 Appendix G (informative) Tests for phase comparators 1-36 kV AC. [The maximum interval for maintenance tests is 6 years]
Operating and earthing sticks	§ 5: Table 1C [A visual inspection for signs of damage or defect must be carried out prior to each use.]	5.5 [Periodic Inspection]	VDE 0681-1 to 3: Description of tests for operating sticks Note: Operating sticks must also be subjected to electrotechnical tests, so that we, DEHN, recommend the test intervals for voltage testers. E DIN VDE V 0681-1-3 Appendix B (informative) [Maintenance tests of operating sticks within 6 years.]

(1) BG ETEM "Visual inspection of portable earthing and short-circuiting devices (portable EaS devices) before installation"; flyer order no. S034 and S035; dated November 2020

(2) BG ETEM "Testing of portable earthing and short-circuiting devices (EaS) Sighting + measuring = testing!" from the magazine "etem", issue 04.2014

PRACTICAL Additional Information

5. Short descriptions

5.1 Materials

Short designation	Materials
Al	Aluminium
AlMgSi	Aluminium alloy
Cu	E-copper, copper
Ms	Brass
StSt	Stainless steel
St	Steel
MCI	Malleable-cast iron
ZDC	zinc die casting
GRP	Glass-fibre reinforced plastic
PP	Polypropylene
PUR	Polyurethane

6. Minimum length of the insulating element for

- 1) Operating sticks as per DIN VDE 0681
- 2) Voltage detectors as per DIN VDE 0682-411 (IEC/EN 61243-1)
- 3) Phase comparator as per DIN VDE 0682-431 (IEC/EN 61481)

Nominal voltage	Rated voltage	Minimum length of the insulating element		
		L _{I min}		
U _N *)	U _r	1)	2)	3)
up to 10 kV	12 kV	500 mm	520 mm	525 mm
20 kV	24 kV	500 mm	520 mm	525 mm
30 kV	36 kV	525 mm	520 mm	525 mm
45 kV	52 kV	720 mm	830 mm	–
60 kV	72.5 kV	900 mm	830 mm	–
110 kV	123 kV	1300 mm	1300 mm	–
150 kV	170 kV	1750 mm	1700 mm	–
220 kV	245 kV	2400 mm	2300 mm	–
380 kV	420 kV	3200 mm	3600 mm	–

*) For nominal voltages outside the preferred values of the nominal voltages listed here, the rated voltage next highest to the nominal voltage should be applied. In borderline cases the nominal voltage is the same as the rated voltage.

5.2 Surface treatment

Short designation	Surface treatment
gal Sn	tin-plated
gal Zn	zinc-plated
HDG	hot-dip galvanised
Bronze gal Sn	Bronze tin-plated

5.3 Conductor types

Short designation	Conductor types
Fl	Flat conductor
Rd	Round conductor

7. Explanation of symbols

Symbol	Use
	Installation instructions, see www.dehn-international.com
	Not for use in wet weather conditions For indoor and outdoor installations For use in indoor and outdoor installations, but not in wet weather.
	for use in wet weather conditions For indoor and outdoor installations For use in indoor and outdoor installations in all weathers (including weather in which the operating sticks might get damp).
	Use in indoor installations only
	Switchgear installations
	Overhead lines
	Kits for railway applications
	New products
	Discontinued products

Services

Shortcut to the right service:
[www.dehn-international.com/en/
services-dehn](http://www.dehn-international.com/en/services-dehn)

High-voltage test laboratory - Automatic product testing	Page 11
DEHNarX - Detecting and evaluating the risk of an arc fault	Page 12
Periodic inspection of protective and auxiliary equipment	Page 14
Earthing and short-circuiting devices - Configure	Page 15
Earthing and short-circuiting devices - Technical testing	Page 16
DEHNacademy - More knowledge for safe working	Page 17



Ensuring everyday safety

DEHN offers practical all-round services for **the organisation** of personal protection in your everyday electrotechnical work.

Buying high-quality and tested products for the implementation of electrical safety rules is only the first step towards safety. By law and by standard, you must regularly check your safety devices

(voltage detectors, EaS devices, insulating sticks). We can do this for you!

You can also leave the professional cleaning of your medium- and low-voltage switchgear installations to us. Another important point:

What is the situation when it comes to assessing the risk of arc faults in your installations? When was the last risk assessment? Here, too, we can now offer you assistance with the DEHNarX service.

You will find your contact person on the next few pages:

One of its kind worldwide: Digitalised high-voltage test laboratory

Thousands of periodic inspections are carried out annually in the DEHN high-voltage test facility. In 2021, significant investments were made in the test facility, which has been in use since 1993. Alongside hardware modifications, such as a new frequency converter, the interactive voice assistant, a globally unique feature, was implemented on the software front. These extensive modifications make the DEHN test facility with voice assistant a unique innovation. The updated emergency shut-off and the safety circuit control system also put the test facility on a high level as far as occupational and plant safety are concerned.

If you have any questions about our test facility or range of services, please contact us: retoure@dehn.de



Automated product testing - advantages for you

- **Quicker periodic inspection**
The processing times for periodic inspections are shorter. Thanks to the optimised, digitalised processes in our high-voltage test field, your safety devices are available again sooner.
- **The test spectrum is widening**
With the new frequency converter, installed for the first time worldwide, it is possible to generate voltages of up to 250 kV in a frequency range of 16.7 to 200 Hz. The voltage quality remains consistently high over the entire voltage range.
- **Process-reliable periodic inspections**
Existing processes are set-up-automated and the entire plant is raised to a new technical level. DEHN employees can initiate the respective test steps via voice assistant. The automation sets the appropriate voltage and the travel of the test setup. The settings and measured values can be monitored on the screens in the test facility.
- **New benchmarks for occupational and plant safety**
The modernisations achieve the highest safety level (Performance Level E) currently achievable for a plant of this type.
- **Customised high-voltage testing**
Contact us for your individual high-voltage tests.





Detecting and evaluating the risk of an arc fault.

DEHNarX Risk Assessment

Evaluate the risk of arc faults and define protection measures according to the TOP principle

Meet the requirements of work safety legislation

The specific task of an "arc fault risk assessment" is not properly clarified in many companies. According to §5 of the German Occupational Health and Safety Act, every employer must carry out an assessment of the electrical hazards for their employees in order to deduce adequate work protection measures.

Can be booked in modular and customised form

The DEHNarX service evaluates arc fault risks/energies according to DGVU-I 203-077 or the American process NFPA 70E / IEEE 1584.

The existing protection measures in your company are checked and optimised, and additional state-of-the-art measures are recommended. Comprehensive documentation right through to safety-increasing system marking can be booked individually. Get in touch with us so that we can put together a customised offer for you.

Which method do you use for risk assessment?

DGVU-I 203-077 is course of action recommended by BG ETEM for dealing with thermal hazards caused by arc faults.

Benefits of DEHNarX Risk Assessment

- **Legitimate.** According to §5 of the German Occupational Health and Safety Act, every employer must carry out an assessment of the electrical hazards for their employees in order to deduce adequate work protection measures.
- **Standard-compliant.** The risk assessment is performed according to DGUV-I 203-077 or the American procedure NFPA 70E / IEEE 1584
- **Modular.** The services of the risk assessment can be customised to requirements.
- **Authoritative.** Based on the assessment, suitable protection measures can be defined as per the TOP principle.
- **Activating.** The results of the risk assessment help the people in charge and fitters reduce the probability of an arc fault occurring.

Those responsible for occupational safety and installations ensure a transparent arc fault protection concept

Create transparency about your arc fault protection concept for all those concerned working on electrical workstations. According to the TOP principle, and in descending order or priority, this includes technical, organisational and personal arc fault protection measures.

When was the last arc fault risk assessment performed at your organisation?

You want to download the customer presentation or require a consultation. Information can be found on the DEHNarX website:





Check voltage detectors regularly

Periodic inspection of protective and auxiliary equipment

DGUV Regulation 3 "Electrical installations and equipment" is the central German accident prevention regulation for electrical engineering. It applies to electrical installations and equipment such as voltage detectors, phase comparators and voltage detecting systems. It is also recommended for non-electrical work in the vicinity of electrical installations and equipment. The inspection intervals for protective and auxiliary equipment are specified in §5 Inspections. As the operator, you are responsible for maintenance, keeping deadlines and conducting the inspection!

Only tested devices protect lives

- Regular maintenance tests ensure that your devices are in a proper and safe condition
Get the benefit of our reminder service
<https://www.dehn.de/de/erinnerungsservice-zur-wiederkehrenden-pruefung>

- Test is documented on the device and in a separate test report
- Periodic inspection of voltage detectors, phase comparators, earthing and short-circuiting devices, etc. at the DEHN Service Centre.
- Periodic inspection at your location earthing and short-circuiting devices

It's simple! Send operating devices such as voltage detectors to DEHN without any prior notification.

You can find all information here:



Use the reminder service!

Here you have the option of having us remind you free of charge of the prescribed periodic inspections in line with DGUV. You can register devices of all manufacturers for the reminder service.

Customers who have DEHN voltage detectors are automatically reminded every **six years!**

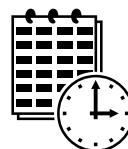

Configure earthing and short-circuiting devices online

The 4th safety rule when working on electrical installations is "earthing and short-circuiting". This secures the de-energised state of the system for the duration of the work against interference voltages, atmospheric surges, unforeseen feedback and erroneous re-connection.

Only an EaS device that has been adapted to your system will ensure that you are safe when working on electrical systems. So, use the EaS configurator with its intuitive navigation to choose the right EaS device.

Customised for you:

- Select place of use, basic structure of the device: 1-pole, 2-pole, 3-pole, material type, cable cross-section, length, connection elements, clamp and earthing stick
- With a variant number you can order a finished product again and again.
A permanent plausibility check takes place in the background.

You can find the new EaS configurator and a demo version here:

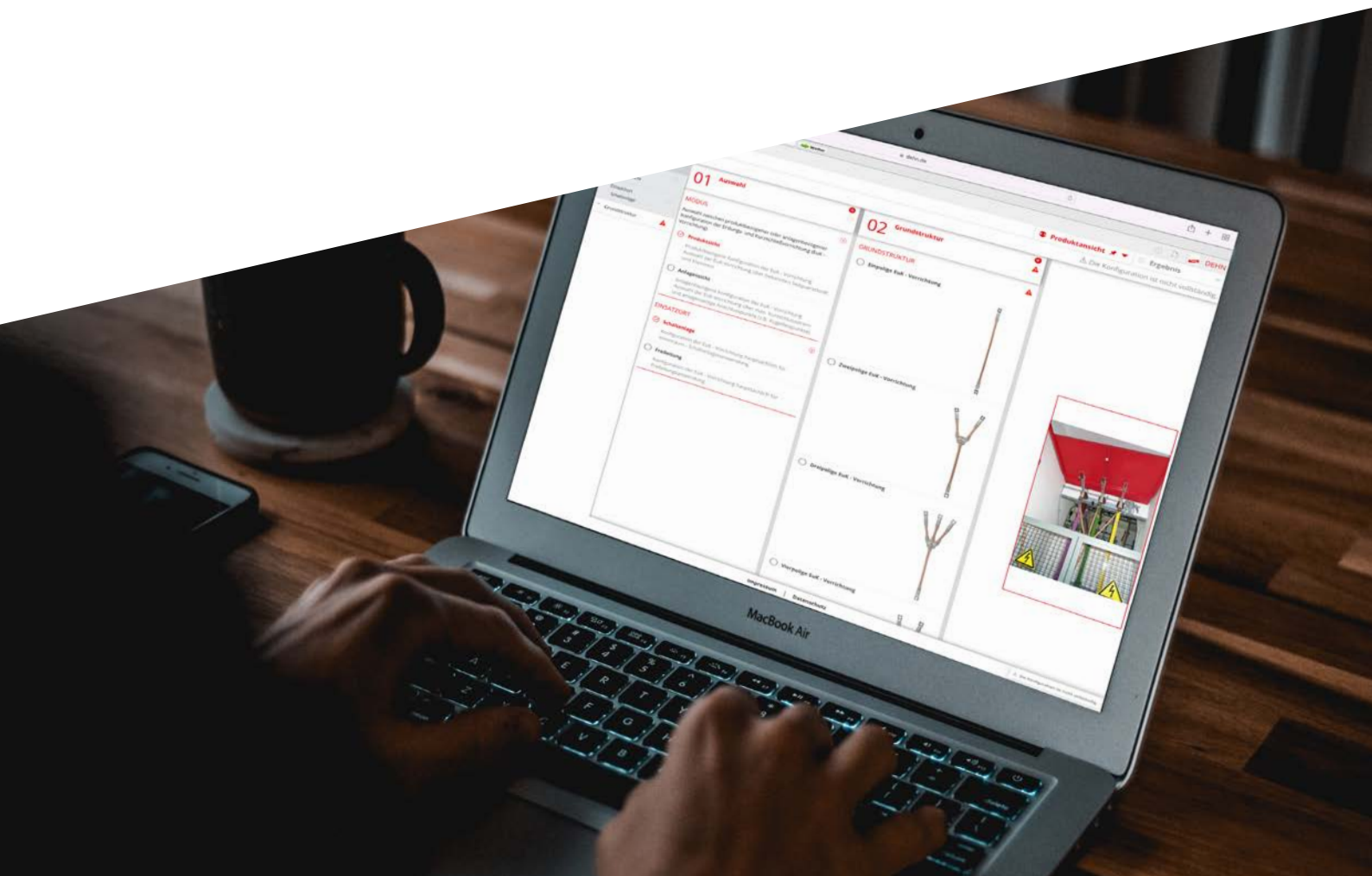



Technical testing of earthing and short-circuiting devices with the LoRe measuring device

Make sure you keep the regular inspection intervals for earthing and short-circuiting devices.

You have two ways of technically assessing the overall condition of your EuK devices with a measurement procedure:

1. Have your EuK devices checked by DEHN

Send us your EaS and we will check your portable safety devices to ensure that they are in perfect working order.

Alternatively, we can inspect your EaS at your location.

Shipping information can be found here:



2. Test your EaS device yourself

With the Lore measuring device, you can detect hidden damage that cannot be revealed by a visual inspection alone. Whereas previously the strands had to be cut open for testing, the EaS devices are now tested non-destructively. Measured values confirm that your EaS is in perfect working order.

More about the loRe measuring device: MikroQmeter LoRe EaS



DEHNAcademy - More knowledge for safe working

In the DEHNAcademy, you will find free online seminars on the subject of "Safe working on electrical installations". You raise awareness among your employees, safeguard and increase plant availability and avoid electrical accidents.

Develop a comprehensive protection concept for your electrical installations step by step, in which you assess the hazards of the activities on your installations, take suitable protective measures and apply them in accordance with the DGUV.

These free online seminars support you in assessing the hazards in your electrical installations, taking suitable protective measures and applying them in compliance with regulations.

Enrol now, for example, for

- **Let's check! Evaluating the arc hazards in your electrical installations**
(approx. 45 min.)

TIP: Search for "Online-Seminar" and "English" in the selection form.

(Last update September 2023 -
Changes are possible)

Registration via the DEHNAcademy platform here:





Safely driving forward electric mobility in your company

Almost 50 percent of new vehicles in Germany were (partially) electric in 2022 – a rapidly increasing trend!

Caution required – comply with occupational health and safety

Ensure the occupational safety of employees working on high-voltage systems during maintenance, salvage, repair, or recovery. DEHN can supply the appropriate safety devices, arc-fault-tested personal protective equipment and necessary warning and barrier products for marking high-voltage work areas.

We are happy to share our knowledge with you in short but informative online seminars.

More information here:



Advertisements

DEHN protects.

www.dehn-international.com

DEHNproX - Safe working on electrical installations

Find the right product quickly and
easily: **EaS Configurator**



Work according to the five safety rules	Page 20
1. Disconnect	Page 21
2. Secure against re-connection	Page 28
3. Verify that the installation is dead	Page 32
4. Earthing and short-circuiting	Page 59
5. Provide protection against adjacent live parts	Page 93
Live working	Page 103









Safe working on electric systems

Good to know: We have a new product family name for our protective and operating equipment for working on electrical installations:

DEHNproX. This made-up word is a combination of DEHN + protect + X. You are already familiar with the company slogan DEHNprotects. It describes DEHN's basic philosophy of providing

protection against hazards. The "X" in the DEHNproX product family name stands for all the hazards averted by high-quality protective equipment (X = crossing out danger). In the area of electrical occupational safety, these are electric shocks and arc faults.

In the DEHNproX product family, you will find all operating and protective equipment for safe working on electrical installations. Listed are products for the implementation of the five safety rules and products for live working.

Application	Nominal voltage U_N / Frequency f_N	Product	Page
<p>IS insulating sticks</p> <ul style="list-style-type: none"> For use in indoor and outdoor installations Screw-on switching stick head allows for use as switching stick Supporting head for hexagon shaft or T pin shaft For use as earthing stick For use as operating stick for insulating protective shutters 	up to 123 kV / 50 Hz		22
<p>Wireless inspection camera</p> <ul style="list-style-type: none"> Periodic visual inspection and documentation of electrical installations and equipment (also without special training) Wireless WiFi camera operation via smartphon/tablet No downtimes due to disconnection of the installation 	up to 150 kV / 15 ... 60 Hz		24
<p>SCS switching sticks</p> <ul style="list-style-type: none"> For use in indoor and outdoor installations Fully insulated, massive switching stick head Allows a deep and safe reach into the installation For use as operating stick for insulating protective shutters 	up to 123 kV / 50 Hz		26
<p>RST rescue rods</p> <ul style="list-style-type: none"> For use in indoor and outdoor installations Fully insulated and fixed rescue hook For rescuing persons from the live working zone in the event of an electrical accident 	up to 72.5 kV / 50 Hz		26
<p>SZ fuse tongs</p> <ul style="list-style-type: none"> Operating head with two adjustable jaws Straight or 20° angled operating head Secure clamping Wide clamping range from Ø30 to 90 mm 	up to 36 kV / 50 Hz		27
<p>Insulating stick with crank handle</p> <ul style="list-style-type: none"> For emergency operating of engine drives For indoor and outdoor installations 	up to 36 kV		28
<p>German Social Accident Insurance (DGUV) Regulation 3 (formerly accident prevention regulations (BGV A3))</p> <p>Operating sticks must be checked according to the DGUV regulation 3 (previously BGV A3) for compliance with the limit values as specified in the electrotechnical rules. This test is carried out in the high-voltage test laboratory at DEHN and includes, among other things:</p> <ul style="list-style-type: none"> Testing the discharge current Testing the protection against bridging Testing by visual inspection, manual test and measuring <p>The maintenance test is documented in a test report and on the device itself. Prior to each use, a visual inspection for outwardly visible damage and defects must be carried out.</p>			7

IS Insulating Sticks



Switching a disconnector by means of an IS SK insulating stick fitted with switching stick head.

Nominal voltages up to 123 kV / 50 Hz

Easy and safe working

- Cost-effective since the application of different supporting heads allows universal use
- Easy handling

General Information:

Standard (switching stick head)	DIN VDE V 0681-2
Standard (insulating stick)	DIN VDE V 0681-1
Standard (operating stick)	DIN VDE 0682-552
Not for use in wet weather conditions	☀
For use in wet weather conditions	☔
For	Indoor and outdoor installations
Material	Glass-fibre reinforced polyester tube

IS SK insulating stick fitted with SSK M12 switching stick head.



IS SQ insulating stick fitted with SSK SQ switching stick head. Black knurled nut for additional locking on the insulating stick.



Insulating Stick, Hexagon Shaft

Operating head with spring locking mechanism and M12 threaded bushing



- Can be used as switching and operating stick by attaching a SSK M12 switching stick head
- Can be used as earthing stick
- Handle closed with end cap



Type	IS 36 SK 1000	IS 36 SK 1500
Part No.	766 001	766 002
Nominal voltage (U _N)	1 ... 36 kV	1 ... 36 kV
Total length (l _G)	1000 mm	1500 mm
Insertion depth (l _O)	175 mm	475 mm
For use at	☀	☀

Insulating Stick, Hexagon Shaft, Plug-in Coupling

Operating head with spring locking mechanism and M12 threaded bushing



- Can be used as switching and operating stick by attaching a SSK M12 switching stick head
- Can be used as earthing stick
- Handle closed with plastic plug-in coupling for extending the handle



Type	IS 36 SK STK 1000	IS 123 SK STK 2000
Part No.	766 100	766 122
Nominal voltage (U _N)	1 ... 36 kV	1 ... 123 kV
Total length (l _G)	1000 mm	2000 mm
Insertion depth (l _O)	175 mm	200 mm
For use at	☀	☀

ISN 36 SK STK 1000

Type	ISN 36 SK STK 1000
Part No.	766 111
Nominal voltage (U _N)	1 ... 36 kV
Total length (l _G)	1000 mm
Insertion depth (l _O)	175 mm
For use at	☔

Accessories for IS Insulating Sticks

Screw-on switching stick head for IS SK insulating Sticks

With M12 thread.

In accordance with DIN VDE V 0681-2.



Type	SSK M12
Part No.	765 005
Material	Steel, plastic-sheathed

Insulating Stick, T Pin Shaft

Operating head with spring-loaded bayonet coupling



- Can be used as switching and operating stick by attaching a SSK SQ switching stick head
- Can be used as operating stick for inserting insulating protective shutters
- Can be used as earthing stick
- Handle closed with end cap



General Information:	
For use at	☀

Type	IS 36 SQ 1000	IS 36 SQ 1500
Part No.	766 311	766 315
Nominal voltage (U _N)	1 ... 36 kV	1 ... 36 kV
Total length (l _G)	1025 mm	1525 mm
Insertion depth (l _O)	150 mm	500 mm

Type	IS 72.5 SQ SN7743
Part No.	766 312
Nominal voltage (U _N)	1 ... 72.5 kV
Total length (l _G)	1300 mm
Insertion depth (l _O)	90 mm

Insulating Stick, T Pin Shaft, Plug-in Coupling

Operating head with spring-loaded bayonet coupling



- Can be used as switching and operating stick by attaching a SSK SQ switching stick head
- Can be used as operating stick for inserting insulating protective shutters
- Can be used as earthing stick
- Handle closed with plastic plug-in coupling for extending the handle



Ø30 mm

Type	IS 36 SQ STK 1000	IS 123 SQ STK 2000
Part No.	766 301	766 322
Nominal voltage (U _N)	1 ... 36 kV	1 ... 123 kV
Total length (l _G)	1025 mm	2000 mm
Insertion depth (l _O)	150 mm	200 mm
For use at		

Type	ISN 36 SQ STK 1000
Part No.	766 310
Nominal voltage (U _N)	1 ... 36 kV
Total length (l _G)	1025 mm
Insertion depth (l _O)	150 mm
For use at	

Insulating Stick, detachable, T Pin Shaft, Plug-in Coupling

Operating head with bayonet coupling with spring locking mechanism



- Can be used as switching stick and operating stick by attaching the switching stick head SSK SQ
- Can be used as operating stick for inserting insulating protective shutters
- Can be used as earthing stick
- Can be used as handle termination with end cap



Ø30 mm

Ø43 mm

Type	ISN 123 SQ STK 2500
Part No.	766 332
Nominal voltage (U _N)	110 ... 123 kV
Total length (l _G)	2495 mm
Insertion depth (l _O)	290 mm
For use at	

Accessories for IS Insulating Sticks

Switching stick head for IS SQ insulating sticks

With T pin shaft (bayonet locking mechanism). In accordance with DIN VDE V 0681-2. T pin shaft in accordance with DIN 48087. Switching stick head is fixed on the insulating stick via the knurled nut.



Type	SSK SQ
Part No.	765 009
Material	Polyamide

Insulating Stick, Plug-in Coupling at both ends

Plug-in coupling at both ends for attaching extension elements, operating heads or adapters.



Ø30 mm

General Information:	
Nominal voltage (U _N)	1 ... 36 kV

Type	IS 36 STK 30 1280	ISN 36 STK 30 1280
Part No.	766 363	766 367
Total length (l _G)	1280 mm	1280 mm
For use at		

Type	ISN 36 STK 930SN7688
Part No.	766 362
Total length (l _G)	930 mm
For use at	

Accessories for IS Insulating Sticks

STK switching stick head



Ø30 mm

Type	SSK 36 STK 560
Part No.	766 164
Total length (l _G)	560 mm

STK operating head / hexagon shaft

Operating head with tension spring locking and M12 threaded bushing for indoor use.



Ø30 mm

Type	AK 36 SK STK 330
Part No.	766 364
Total length (l _G)	330 mm

STK operating head / T pin shaft

Operating head with spring-loaded bayonet coupling for indoor use.



Ø30 mm

Type	AK 36 SQ STK 360
Part No.	766 365
Total length (l _G)	360 mm

Adapter with flat lock bushing

and plug-in coupling for attaching WOLF gardening tools



Ø30 mm

Type	AD FB18 7 STK SN7007
Part No.	766 321
Total length	300 mm
Dimension (bushing)	18 x 7 mm

Note: WOLF gardening tools with adapter are not protected against bridging (electrical safety)!

Wireless Inspection Camera



System monitoring with wireless inspection camera and live display on a smartphone.

Nominal voltages up to 150 kV / 15 to 60 Hz

- Wireless inspection camera for periodic visual inspection and for documenting the state of electrical installations and equipment (also without special training)
- Brings the invisible to light
- Facilitates work, increases safety, saves time



General Information:

Standard	based on EN 50508 (DIN VDE 0682-213)
Temperature range (T _U)	0 °C ... +40 °C
Not for use in wet weather conditions	☀
Material (enclosure)	PUR
Material (camera)	Aluminium

AC2 digital camera set



Kit includes:

No.	Description	Type
1	Plastic case	KKL DIGIK AC2
2	Digital camera enclosure	G DIGIK AC2
3	Camera and battery module incl. magn. protective cover	DIGIK AC2
4	Magnetic adapter holder with 1/4" thread	MAH DIGIK AC2
5	Rigid adapter gear coupling	ADS ZK 185

Type	SET DIGIK AC2
Part No.	766 480 <small>NEW</small>
Nominal voltage (U _N)	up to 150 kV
Frequency	15-60 Hz
Resolution	12 megapixels
Objective	Ultra-wide angle (155° field of view)
Digital zoom	4x
sensor	1/1.7" 4K CMOS sensor
Image stabiliser	Electronic
Formats	JPEG/RAW and MP4
Internal memory	22 GB
Ext. SD card	microSD (max. 256 GB) *)
Equipment	Remote control via app
Voice command	Yes
Interfaces	USB type-C
Dimensions (case)	395 x 290 x 105 mm

*) Handle, insulating sticks and micro SD card are not included.

Accessories for wireless Inspection Camera

Macro lens

For close-ups



Type	MO DIGIK AC2
Part No.	766 483 <small>NEW</small>
Dimensions	40 x 40 x 10 mm

Handle with gear coupling



Type	HG ZK 230
Part No.	766 393
Nominal voltage U _N AC	up to 1000 V / 15 ... 60 Hz
Nominal voltage U _N DC	up to 1500 V
Total length (l _G)	230 mm

Insulating stick with handle and plug-in coupling

Consisting of one element.



Type	IS 36 ZK STK 1300
Part No.	785 325
Nominal voltage (U _N)	up to 36 kV
Total length (l _G)	1300 mm
Length (handle) (l _H)	560 mm

Insulating stick with handle and plug-in coupling

Modular. For use as operating stick with handle, hand guard, insulating element, red ring and extension, extendible handle.



Type	IS T 36 ZK STK 1300
Part No.	785 315
Nominal voltage (U _N)	up to 36 kV
Total length	1300 mm
Length (handle) (l _H)	560 mm

Adapter with gear coupling

With plug-in coupling.



Type	AD ZK STK 30 360
Part No.	766 359
Total length (l _G)	360 mm

Operating stick set

Set for animal guard adapter and wireless inspection camera.



Type	ASSN 36 STK ZK
Part No.	766 380
Nominal voltage (U _N)	1 ... 36 kV
Max. total length (l _{G,max})	6780 mm
DB drawing No.	3 Egbw 04.61

Insulating stick (T pin shaft)

Operating head with spring loaded bayonet coupling.



Type	IS 36 SQ 1000	IS 36 SQ 1500
Part No.	766 311	766 315
Nominal voltage (U _N)	1 ... 36 kV	1 ... 36 kV
Total length (l _G)	1025 mm	1525 mm
Length (handle) (l _H)	350 mm	500 mm

Adapter (T pin shaft / gear coupling)

For insulating sticks with cone coupling for T pin shafts (bayonet locking mechanism). The lock nut allows to fix the adapter on the insulating stick.



Type	AD SQ ZK 165
Part No.	766 396
Length	182 mm

Rigid adapter with gear coupling

With 1/4" thread for housing wireless inspection camera.



Type	ADS ZK 185
Part No.	766 389
Total length (l _G)	185 mm
Thread	1/4" BS
Colour	yellow

Flexible adapter with gear coupling

With 1/4" thread for housing wireless inspection camera.



Type	AD ZK 185
Part No.	766 392
Total length (l _G)	185 mm
Colour	yellow

Extension with gear coupling



Type	ISV 220 ZK MS	ISV 320 ZK MS
Part No.	785 316	785 317
Total length (l _G)	220 mm	320 mm

Type	ISV 420 ZK MS	ISV 820 ZK MS
Part No.	785 318	785 319
Total length (l _G)	420 mm	820 mm

ISV 36 STK insulating stick extension

Plug-in coupling at both ends for extending the insertion depth or the handle.



Type	ISV 36 STK 30 910	ISV 36 STK 30 1280
Part No.	766 356	766 366
Total length (l _G)	910 mm	1280 mm

HV STK extension handle

Plug-in coupling at both ends for extending the handle.



Type	HV STK 30 710	HV STK 43 910
Part No.	766 335	766 456
Total length	710 mm	910 mm
Diameter	30 mm	43 mm

Type	HV STK 43 1280
Part No.	766 466
Total length	1280 mm
Diameter	43 mm

Insulating stick (T pin shaft / plug-in coupling)

Operating head with spring loaded bayonet coupling.



Type	IS 123 SQ STK 2000
Part No.	766 322
Nominal voltage (U _N)	1 ... 123 kV
Total length (l _G)	2000 mm
Length (handle) (l _H)	500 mm

Insulating stick extensions

With gear coupling



General Information:	
Nominal voltage (U _N)	123 kV

Type	ISV 220 ZK 123 SN7739	ISV 320 ZK 123 SN7740
Part No.	785 311	785 312
Total length (l _G)	220 mm	320 mm

Type	ISV 420 ZK 123 SN7741	ISV 820 ZK 123 SN7742
Part No.	785 313	785 314
Total length (l _G)	420 mm	820 mm

SCS Switching Sticks



Switching a disconnector by means of an SCS switching stick.

Nominal Voltages up to 36 kV

Handle sealed with plastic plug-in coupling for extending the handle.



Type	SCS 36 STK 1000	SCSN 36 STK 1000
Part No.	763 100	763 111
Nominal voltage (U _N)	1 ... 36 kV	1 ... 36 kV
Total length (l _G)	1000 mm	1000 mm
Insertion depth (l _O)	135 mm	135 mm
For use at		

RST Rescue Rods



Insulated RST rescue rod used to rescue a victim of electrical shock from the live working zone.

Nominal voltages up to 72.5 kV / 50 Hz

Easy and safe working

- Cost-effective
- User-friendly

General Information:

Standard (switching stick head)	DIN VDE V 0681-2
Standard (switching stick)	DIN VDE V 0681-1 and -2
Standard (insulating stick)	DIN VDE V 0681-1
Standard (operating stick)	DIN VDE 0682-552
Not for use in wet weather conditions	
For use in wet weather conditions	
For	For indoor and outdoor installations
Design	Fully insulated, massive switching stick head
Material (insulating tube)	Glass-fibre reinforced polyester tube
Material (switching pin)	Steel, plastic-sheathed

Nominal Voltages up to 72.5 kV

With end cap.



General Information:

For use at	
------------	--

Type	SCS 36 1000	SCS 36 1500
Part No.	763 610	763 611
Nominal voltage (U _N)	1 ... 36 kV	1 ... 36 kV
Total length (l _G)	1030 mm	1500 mm
Insertion depth (l _O)	135 mm	415 mm

Type	SCS 36 2000	SCS 72 1500
Part No.	763 612	763 615
Nominal voltage (U _N)	1 ... 36 kV	1 ... 72.5 kV
Total length (l _G)	2000 mm	1500 mm
Insertion depth (l _O)	765 mm	290 mm

Type	SCS 72 2000	SCS 72 3000
Part No.	763 620	763 630
Nominal voltage (U _N)	1 ... 72.5 kV	1 ... 72.5 kV
Total length (l _G)	2000 mm	3000 mm
Insertion depth (l _O)	690 mm	1500 mm

Nominal voltages up to 72.5 kV / 50 Hz

- For use in indoor and outdoor installations
- Fixed rescue hook (protected against bridging)
- For rescuing persons weighing up to approximately 100 kg from the live working zone in the event of an electrical accident



General Information:

Standard	based on DIN VDE V 0681-1
Not for use in wet weather conditions	
Material (hook)	PVC-HI solid rod
Material (insulating tube)	Glass-fibre reinforced polyester tube
End fitting	Non-slip plastic cap



Rescue Rod up to 36 kV



Type RST ...	36 1000	36 1500
Part No.	766 040	766 041
Nominal voltage (U _N)	1 ... 36 kV	1 ... 36 kV
Total length (l _G)	1235 mm	1695 mm
Insertion depth (l _O)	410 mm	620 mm

Type RST ...	36 2000	72.5 1500
Part No.	766 042	766 043 <small>NEW</small>
Nominal voltage (U _N)	1 ... 36 kV	1 ... 72.5 kV
Total length (l _G)	2195 mm	1525 mm
Insertion depth (l _O)	970 mm	325 mm

SZ Fuse Tong



SZ fuse tongs for inserting and removing HH fuses.

Nominal voltages up to 36 kV / 50 Hz Easy and safe working

- User-friendly



The reducing insert delivered with the SZ fuse tong allows low clamping ranges from Ø30 to 50 mm. Without reducing insert, HV HBC fuses from Ø50 to 90 mm can be actuated.



In practice, the 20° angled operating head allows safe and easy actuation of HH fuses that are not easily accessible.



General Information:	
Standard	DIN VDE V 0681-3
Not for use in wet weather conditions	☀
Design	Straight and 20° angled clamp body
Clamping range	Wide clamping range from Ø30 to 90 mm
Material (insulating stick)	Glass-fibre reinforced polyester tube
Material (operating head)	Glass-fibre reinforced polyamide
Material (adjustable handle)	Polyamide
Material (reducing insert)	Polyamide
Colour	Grey ●

Straight version



General Information:	
Nominal voltage (U _N)	1 ... 36 kV
Clamping range	30 ... 50 ^{*)} / 50 ... 90 mm
Insertion depth (l ₀)	185 mm

Type SZ HH ...	1060	1250
Part No.	765 040	765 041
Total length (l _G)	1060 mm	1250 mm

Type SZ HH ...	1500
Part No.	765 042
Total length (l _G)	1500 mm

^{*)} Only if used with reducing insert

20° angled version



General Information:	
Nominal voltage (U _N)	1 ... 36 kV
Clamping range	30 ... 50 ^{*)} / 50 ... 90 mm
Insertion depth (l ₀)	195 mm

Type SZ HH ...	W20 1070	W20 1250
Part No.	765 050	765 051
Total length (l _G)	1070 mm	1250 mm

Type SZ HH ...	W20 1500
Part No.	765 052
Total length (l _G)	1500 mm

^{*)} Only if used with reducing insert

Accessories for SZ Fuse Tongs

Storage device for HH fuses

Wall-mounted.



Type	HV 3HH ET
Part No.	700 005
For	HH fuses

Note: Two storage devices are required!

Storage device for HH fuses and fuse tong

Wall-mounted.



Type	HV 3HH SZ ET
Part No.	700 004
For	HH fuses and fuse tong

Note: Two storage devices are required!

Storage device kit for HH fuses or HH fuses and fuse tong

Wall-mounted.



Type	HV 3HH	HV 3HH SZ
Part No.	700 015	700 014
Consisting of	2x HV 3HH ET	1x HV 3HH ET and 1x HV 3HH ZS ET

DEHNproX - 1. Disconnect completely

Insulating Stick with Crank Handle



Insulating stick with crank handle for emergency operation of motor-driven disconnectors.

Nominal voltages up to 36 kV / 15 ... 60 Hz

- For emergency operating of engine drives
- For indoor and outdoor installations



General Information:

Standard	DIN VDE V 0681-1
Not for use in wet weather conditions	☀
Material (operating head)	Plastic
Material (extension)	Glass-fibre reinforced polyester tube
Material (test unit)	Glass-fibre reinforced polyester tube

Operating Head

With hexagon shaft 24 mm and hexagon coupling 12 mm.



Ø30 mm

Type	AK SK24 SK12
Part No.	763 712
Total length (l _G)	120 mm
For use at	☀

Insulating Stick with Crank Handle

With hexagon coupling 12 mm and button.



Ø30 mm

Type	IS SK12 HK 1720
Part No.	763 710
Nominal voltage (U _N)	1 ... 36 kV
Total length (l _G)	1720 mm
Insertion depth (l _O)	540 mm
For use at	☀

Insulating Stick Extension

With hexagon coupling 12 mm and button.



Ø30 mm

Type	ISV SK12 1060
Part No.	763 711
Nominal voltage (U _N)	1 ... 36 kV
Total length (l _G)	1060 mm
For use at	☀

2. Secure against Re-Connection

Lock-Out Systems



Lock-out system for three modular widths.

Nominal voltages up to 1000 V

- Protection against re-connection
- Symbol „Nicht schalten“ [Do not close the circuit] acc. to German regulation (ASR A13)



Insulating Plug

For screw inserts.



General technical data:

PU	10 pc(s)
----	----------

Type SE ...	E14	E18
Part No.	785 639	785 650
Size	E14	E18
Diameter	20 mm	25 mm
Dimensions	Ø20 x 40 mm	Ø25 x 40 mm

Type SE ...	E27 E33
Part No.	785 640
Size	E27 and E33
Diameter	45 mm
Dimensions	Ø45 x 55 mm

Insulating Blade

For NH fuse holders and distribution blocks.



General technical data:

PU	10 pc(s)
----	----------

Type SE ...	NH00	NH0
Part No.	785 641	785 642
Size	00	0
Blade	13 x 5 mm	38 x 5 mm
Dimensions	80 mm	125 mm

Type SE ...	NH1	NH2 3
Part No.	785 643	785 644
Size	1	2 and 3
Blade	38 x 5 mm	38 x 5 mm
Dimensions	135 mm	150 mm

Lock-Out System

For single-pole and multipole circuit breakers with a clamping range of 45 mm.



General technical data:

PU	10 pc(s)	
Type SE ...	REG 1TE	REG 2TE
Part No.	785 638	785 652
Size	1 modular width	2 modular widths
Dimensions	52 x 17 mm	52 x 34 mm
Type SE ...	REG 3TE	
Part No.	785 637	
Size	3 modular widths	
Dimensions	52 x 51 mm	

Barrier and Accessories



Barrier in a transformer station.

- Barrier and accessories for providing protection for installation parts.

Barrier

Robust design, suitable for indoor and outdoor installations.



Type	AB 32 46 RW K L...
Part No.	700 099
Material	Glass-fibre reinforced polyester
Dimensions (W x H)	32 x 46 mm
Length	Any up to 6000 mm *)
Material thickness	6 mm
Colour	Red ● / white ○

*) Length to be specified when ordering!

Barrier Holder

1 pack = 2 pieces.



Type	H AB 32 46 K
Part No.	700 098
Material	Plastic
Material thickness	6 mm
Colour	Red ●

E-mobility warning signs



Clearly visible warning signs on the e-vehicle.

Warning cross: "Attention - Voltage! Unauthorised access prohibited"

With suction cups for secure placement and fixing.



Type WHS AS ...	ZFUV
Part No.	700 060 NEW
Dimensions (L x W x H)	280 x 280 x 150 mm
Material	Free foam, weather-resistant

Warning sign: "Attention - Voltage! Unauthorised access and contact prohibited"

Including attachment contour for plastic posts.



Type WHS AS ...	BSZFUV
Part No.	700 059 NEW
Dimensions (W x H)	210 x 280 mm
Material	Free foam, weather-resistant

Warning sign: "Attention - Voltage! Switching prohibited"

Including drill hole.



Type WHS AS ...	SV
Part No.	700 058 NEW
Dimensions (W x H)	54 x 86 mm
Material	Plastic

Chain post set



Chain post set for securing the work area.

- For sealing off the workplace (6 posts, 10-m chain, 10 links, 10 hooks).

Chain post set Secur



Type KTST SET 6ZFS ...	RTWS 10M KT	GBSW 10M KT
Part No.	700 110 NEW	700 111 NEW
Colour	Red ● / white ○	Yellow ● / black ●
Post material	Plastic	Plastic
Base material	Cement	Cement

Accessories for Chain post set

Barrier chain Secur







Colour change after 13 links.



Type	ASKT RTWS 10 M KST	ASKT GBSW 10 M KST
Part No.	700 112 NEW	700 113 NEW
Material	Plastic	Plastic
Colour	Rot ● / white ○	Yellow ● / black ●
Link thickness	6 mm	6 mm



DEHNproX - 3. Verify that the installation is dead - Voltage detectors

Description / Type	Nominal voltage U_N / Frequency f_N	Product	Page
PHE4 voltage detector <ul style="list-style-type: none"> For use in wet weather conditions For indoor and outdoor installations Visual and acoustic indication Self-test of all live parts (up to 36 kV) Large nominal voltage range 	up to 30 kV / 50 or 60 Hz up to 30 ... 420 kV / 50 Hz up to 33 kV / 50 Hz (British Influenced Voltage Level)		34
PHE III voltage detector / PHE III ZK indicator with test prod / PHE III set <ul style="list-style-type: none"> For use in wet weather conditions For indoor and outdoor installations With self-testing element Visual and acoustic indication Quick battery replacement, without tools 	up to 30 kV / 50 Hz up to 30 kV / 50 Hz (with standby function) 20 and 60 ... 110 kV / 50 Hz		37 38 40
PHG II voltage detector <ul style="list-style-type: none"> Use in indoor installations only Visual indication via three LEDs offset by 120° Passive voltage detector without batteries 	6 / 10 / 20 kV / 50 Hz		39
ASP /HSA distance voltage detector <ul style="list-style-type: none"> For use in wet weather conditions Distance voltage detector For overhead lines and outdoor switching stations With self-testing element Visual and acoustic indication 	110 ... 420 kV / 50 Hz or 16.7 Hz 1 ... 420 kV / 50 Hz, 60 Hz or 16.7 Hz		41 42
PHE/G DC voltage detector <ul style="list-style-type: none"> For use in wet weather conditions For indoor and outdoor installations With self-testing element Visual indicator Two-pole (one-/two-stick) 	up to 24 kV / DC voltage		44
SPN voltage detector for power supply <ul style="list-style-type: none"> For use in wet weather conditions No battery required For use in overhead line networks by attaching extension prods 	50 ... 500 V 50 ... 1000 V		45
SPN voltage detector for the electrical trade and industry <ul style="list-style-type: none"> Analogue and digital version No batteries required for analog device 	12 ... 1000 V AC / DC 1.0 ... 1000 V AC / 1200 V DC		46
Accessories, storage and transport cases <ul style="list-style-type: none"> Electrodes, probes, adapters, end fittings, storage devices Cases, bags 			54 55
Discharge devices <ul style="list-style-type: none"> For discharging static charges Different contact electrodes 			57

German Social Accident Insurance (DGUV) Regulation 3 (formerly accident prevention regulations (BGV A3))

Voltage detectors must be checked according to the DGUV regulation 3 (previously BGV A3) for compliance with the limit values as specified in the electrotechnical rules. This test is carried out in the high-voltage test laboratory at DEHN and includes, among other things:

- Testing the discharge current
- Testing for clear indication
- Testing the protection against bridging
- Testing by visual inspection, manual test and measuring

The maintenance test is documented in a test report and on the device itself.

The intervals for maintenance tests of voltage detectors depend on their conditions of use, e.g. frequency of use, stress due to environmental conditions and transport, etc, however, according to DGUV regulation 3, **at least every 6 years**.



Structure of the voltage detector

Voltage detectors according to IEC/EN 61243-1 (DIN VDE 0682-411) are designed to verify on all poles at the work location that the installation is dead according to EN 50110-1 (DIN VDE 0105-100). Only electrotechnically skilled or instructed persons are allowed to verify on all poles at the work location or as close as possible to the work location that the installation is dead.

Voltage detectors must be tested for correct operation immediately before and after use. Correct operation of voltage detectors without self-testing element must be verified by contacting a part of the installation connected to operating voltage. Verifying that the installation is dead using a voltage detector is considered live working.

Voltage detectors may only be used for the nominal voltages / nominal voltage ranges as indicated on the rating plate. The user may be at risk if the voltage detector is used for voltages other than indicated on the rating plate (incorrect indication, electric shock, arcing).

Voltage detectors labelled with "For indoor use only" may only be used in indoor installations.

Voltage detectors labelled with "For use in wet weather conditions" may be used in all weather conditions (rain, snow, fog and dew).

Voltage detectors according to IEC/EN 61243-1 (DIN VDE 0682-411) are only suitable to a limited extent for use in **factory assembled (type-tested) installations**. If space in installations is confined, flashover may occur when inserting the test prod into the installation. The user of the voltage detector or the operator of the switchgear installation must contact the manufacturer of the type-tested installation to find out whether the voltage detector may be used in the installation (please refer to the table on the next page: Application of voltage detectors in type-tested, factory assembled switchgear installations).

Design of voltage detectors

Voltage detectors according to IEC/EN 61243-1 (DIN VDE 0682-411) are **single-pole** devices designed to make contact with the part of the installation to be tested.

There are **two mechanically different designs** of voltage detectors: Complete and separate voltage detectors.

Complete voltage detectors (PHE4, PHE III, PHE and PHG II) consist of an insulating stick, indicator and test prod and are tested as a complete unit.

Separate voltage detectors (PHE III indicator with test prod) must be attached to a suitably rated insulating stick.

Single-pole **voltage detectors** typically consist of a **handle, insulating element, indicator** and **test prod with contact electrode**.

The **insulating element** is the section of a voltage detector between the hand guard and the red ring. It ensures that the user maintains an adequate safety distance for safe operation. The **test prod** (contact electrode extension) with a contact electrode **above the red ring** allows to reach remote parts of the installation and to **eliminate** the influence of **interference fields**.

Voltage detectors are classified into two categories based on their behaviour in case of interference fields or their field of application. Voltage detectors of **category "L"** (line) with a short test prod (without contact electrode extension) are designed for use on overhead lines.

Voltage detector of **category "S"** (switchgear) with a long test prod (with contact electrode extension) are resistant to interference fields and are therefore used in switchgear installations. They are also suitable for overhead lines.

The **hand guard** provides a visible barrier between the handle and the insulating element and prevents the user from making contact with the insulating element.

The **red ring** indicates the end of the insulating element in the direction of the test electrode. This provides the user with a visible limit for contact with live parts in the installation. The **insulating element** between the red ring and the hand guard must not contact live parts, however, it may contact earthed parts.

The **test electrode** is the part of the voltage detector that is used to make contact with the part of the installation to be tested.

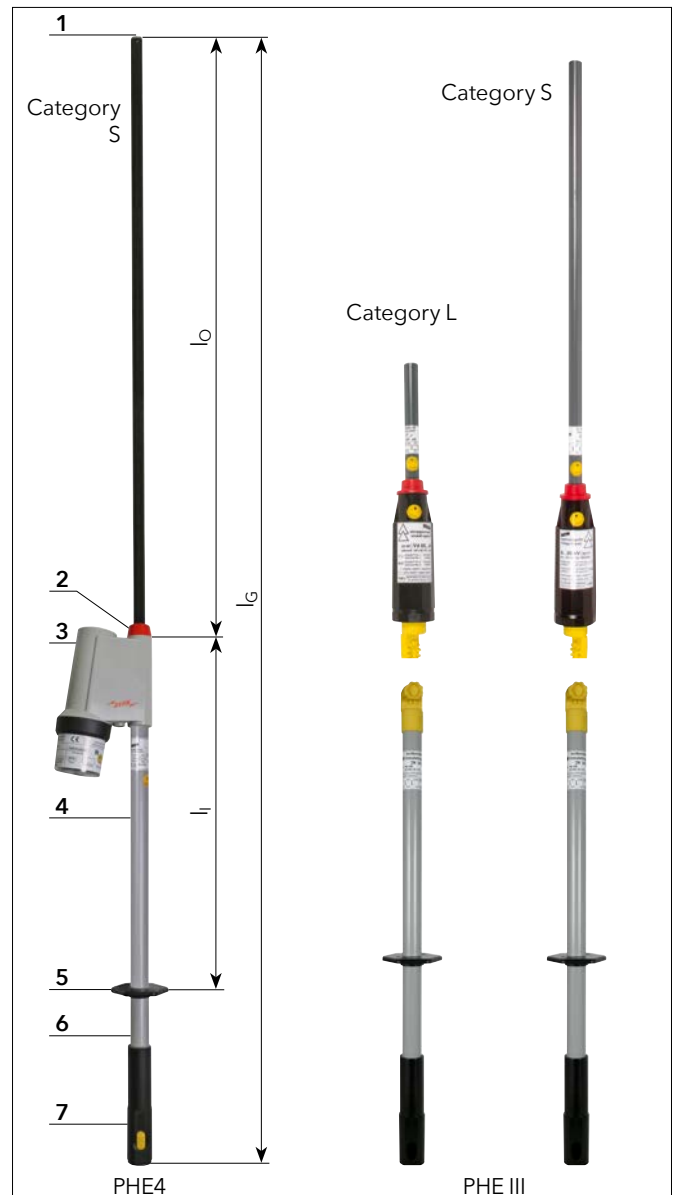

- 1 Test electrode
- 2 Red ring
- 3 Operating head / Indicator
- 4 Insulating element
- 5 Hand guard
- 6 Handle
- 7 Plug-in coupling for extending the handle
- l_G Total length of the voltage detector
- l_0 Length of the top section
- l_I Length of the insulating element

DEHNproX - Safe working on electrical installations / Live working

PHE4 Voltage Detector Medium Voltage



PHE4 voltage detector with visual and acoustic indication.

- Self-test of all live parts including test prod
- Unique plug-in coupling system
- Integrated visual and acoustic indication
- Also for use in wet weather conditions

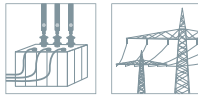

General technical data:

Standard	EN/IEC 61243-1 (DIN VDE 0682-411)
Temperature range	-25 °C ... +70 °C, climatic category N and W
Design	Complete
For use in wet weather conditions	
For	Indoor and outdoor installations
Indication	Acoustic and visual
Self-testing element	Yes
Material (test electrode)	Cu alloy/gal Sn
Material (test prod)	Glass-fibre reinforced epoxy resin tube
Material (indicator)	Plastic, fully insulated
Material (insulating stick)	Glass-fibre reinforced polyester tube

Nominal Voltages up to 30 kV / 50 Hz, M12 Thread

Category "S" for switchgear installations and overhead lines.



Type PHE4 ...	3 S	6 S
Part No.	783 003	783 006
Nominal voltage (U _N)	3 kV	6 kV
Total length (l _G)	1030 mm	1030 mm
Insertion depth (l _O)	230 mm	230 mm

Type PHE4 ...	10 S	20 S
Part No.	783 010	783 020
Nominal voltage (U _N)	10 kV	20 kV
Total length (l _G)	1030 mm	1200 mm
Insertion depth (l _O)	230 mm	400 mm

Type PHE4 ...	30 S
Part No.	783 030
Nominal voltage (U _N)	30 kV
Total length (l _G)	1720 mm
Insertion depth (l _O)	920 mm

Nominal Voltages up to 36 kV / 50 Hz, M12 Thread

Category "S" for switchgear installations and overhead lines.



Type PHE4 ...	1 3 S	3 10 S
Part No.	783 013	783 231
Nominal voltage (U _N)	1 ... 3 kV	3 ... 10 kV
Total length (l _G)	1410 mm	1410 mm
Insertion depth (l _O)	610 mm	610 mm

Type PHE4 ...	6 20 S	10 20 S
Part No.	783 235	783 240
Nominal voltage (U _N)	6 ... 20 kV	10 ... 20 kV
Total length (l _G)	1600 mm	1410 mm
Insertion depth (l _O)	800 mm	610 mm

Type PHE4 ...	10 30 S	20 36 S
Part No.	783 250	783 245
Nominal voltage (U _N)	10 ... 30 kV	20 ... 36 kV
Total length (l _G)	1720 mm	1720 mm
Insertion depth (l _O)	920 mm	920 mm

Nominal Voltages up to 36 kV / 50 Hz, switchable, M12 Thread

Category "S" for switchgear installations and overhead lines.



Type PHE4 ...	U 2 20 S	U 3 30 S
Part No.	783 520	783 530
Nominal voltage (U _N)	2 ... 6 / 6 ... 20 kV	3 ... 10 / 10 ... 30 kV
Total length (l _G)	1600 mm	1720 mm
Insertion depth (l _O)	800 mm	920 mm

Type PHE4 ...	U 6 36 S
Part No.	783 536
Nominal voltage (U _N)	6 ... 15 / 15 ... 36 kV
Total length (l _G)	1720 mm
Insertion depth (l _O)	920 mm

Nominal Voltages up to 30 kV / 50 Hz, Gear Coupling

Category "S" for switchgear installations and overhead lines.



Type PHE4 ...	3 S ZK	6 S ZK
Part No.	783 103	783 106
Nominal voltage (U _N)	3 kV	6 kV
Total length (l _G)	1070 mm	1070 mm
Insertion depth (l _O)	230 mm	230 mm

Type PHE4 ...	10 S ZK	20 S ZK
Part No.	783 110	783 120
Nominal voltage (U _N)	10 kV	20 kV
Total length (l _G)	1070 mm	1240 mm
Insertion depth (l _O)	230 mm	400 mm

Type PHE4 ...	30 S ZK
Part No.	783 130
Nominal voltage (U _N)	30 kV
Total length (l _G)	1760 mm
Insertion depth (l _O)	920 mm

DEHNproX - 3. Verify that the installation is dead - Voltage detectors

**Nominal Voltages up to bis
30 kV / 50 Hz, Gear Coupling**
Category "S" for switchgear
installations and overhead lines.



Type PHE4 ...	3 10 S ZK	6 20 S ZK
Part No.	783 141	783 151
Nominal voltage (U _N)	3 ... 10 kV	6 ... 20 kV
Total length (l _G)	1450 mm	1640 mm
Insertion depth (l _O)	610 mm	800 mm

Type PHE4 ...	10 30 S ZK
Part No.	783 161
Nominal voltage (U _N)	10 ... 30 kV
Total length (l _G)	1760 mm
Insertion depth (l _O)	920 mm

**Nominal Voltages up to
36 kV / 60 Hz, M12 Thread**
Category "S" for switchgear
installations and overhead lines.



General technical data:	
Frequency	60 Hz

Type PHE4 ...	3 10 S 60	6 20 S 60
Part No.	783 332	783 335
Nominal voltage (U _N)	3 ... 10 kV	6 ... 20 kV
Total length (l _G)	1410 mm	1600 mm
Insertion depth (l _O)	610 mm	800 mm

Type PHE4 ...	10 30 S 60	20 36 S 60
Part No.	783 345	783 342
Nominal voltage (U _N)	10 ... 30 kV	20 ... 36 kV
Total length (l _G)	1720 mm	1720 mm
Insertion depth (l _O)	920 mm	920 mm

Type PHE4 ...	U 3 36 S 60
Part No.	783 395
Nominal voltage (U _N)	3 ... 10 / 12 ... 36 kV
Total length (l _G)	1720 mm
Insertion depth (l _O)	920 mm

PHE4 Voltage Detector High Voltage



PHE4 voltage detector applied in a 110 kV outdoor switching station.

- High nominal voltage range
- Unique plug-in coupling system
- Integrated visual and acoustic indication
- Also for use in wet weather conditions

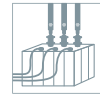

General technical data:	
Standard	EN/IEC 61243-1 (DIN VDE 0682-411)
Temperature range	-25 °C ... +70 °C, climatic category N and W
Design	Complete
For use in wet weather conditions	
For	Indoor and outdoor installations
Indication	Acoustic and visual
Self-testing element	Yes
Material (test electrode)	Cu-alloy/gal Sn
Material (test prod)	PP
Material (indicator)	Plastic, fully insulated
Material (insulating stick)	Glass-fibre reinforced polyester tube

**Nominal voltage ranges
30 ... 132 kV / 50 Hz,
M12 thread**



Category "S" for switchgear
installations and overhead lines.



General technical data:	
Insertion depth (l _O)	910 mm

Type PHE4 ...	30 60 S	60 110 S
Part No.	783 270	783 275
Nominal voltage (U _N)	30 ... 60 kV	60 ... 110 kV
Total length (l _G)	2560 mm	3010 mm

Type PHE4 ...	60 132 S
Part No.	783 280
Nominal voltage (U _N)	60 ... 132 kV
Total length (l _G)	3420 mm

**Nominal Voltage Ranges
110 ... 420 kV / 50 Hz,
M12 Thread**



Category "S" for switchgear
installations and overhead lines.



Type PHE4 ...	110 220 S	220 420 S
Part No.	783 285	783 290
Nominal voltage (U _N)	110 ... 220 kV	220 ... 420 kV
Total length (l _G)	4420 mm	5750 mm
Insertion depth (l _O)	910 mm	910 mm

PHE4 Voltage Detector (British Influenced Voltage Level)



PHE4 voltage detector with visual and acoustic indication.

- Self-test of all live parts (including test prod category „S“)
- Unique plug-in coupling system
- Integrated visual and acoustic indication
- Also for use in wet weather conditions

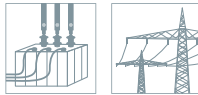

General technical data:

Standard	EN/IEC 61243-1 (DIN VDE 0682-411)
Temperature range	-25 °C ... +70 °C, climatic category N and W
Design	Complete
For use in wet weather conditions	
For	Indoor and outdoor installations
Indication	Acoustic and visual
Self-testing element	Yes
Material (test electrode)	Copper alloy/gal Sn
Material (test prod)	Glass-fibre reinforced epoxy resin tube
Material (indicator)	Plastic, fully insulated
Material (insulating stick)	Glass-fibre reinforced polyester tube

Nominal Voltages up to 33 kV / 50 Hz, M12 Thread
Category "S" for switchgear installations and overhead lines.



Type PHE4 ...	3.3 S	6.6 S
Part No.	783 033	783 066
Nominal voltage (U _N)	3.3 kV	6.6 kV
Total length (l _G)	1030 mm	1030 mm
Insertion depth (l _O)	230 mm	230 mm

Type PHE4 ...	11 S	22 S
Part No.	783 011	783 022
Nominal voltage (U _N)	11 kV	22 kV
Total length (l _G)	1030 mm	1200 mm
Insertion depth (l _O)	230 mm	400 mm

Type PHE4 ...	33 S
Part No.	783 045
Nominal voltage (U _N)	33 kV
Total length (l _G)	1720 mm
Insertion depth (l _O)	920 mm

Nominal Voltage Ranges up to 33 kV / 50 Hz, M12 Thread
Category "S" for switchgear installations and overhead lines.



Type PHE4 ...	3.3 11 S	6.6 22 S
Part No.	783 233	783 243
Nominal voltage (U _N)	3.3 ... 11 kV	6.6 ... 22 kV
Total length (l _G)	1410 mm	1600 mm
Insertion depth (l _O)	610 mm	800 mm

Type PHE4 ...	11 33 S
Part No.	783 255
Nominal voltage (U _N)	11 ... 33 kV
Total length (l _G)	1720 mm
Insertion depth (l _O)	920 mm

Nominal Voltage Ranges up to 33 kV / 50 Hz, switchable, M12 Thread



Category "S" for switchgear installations and overhead lines.



Type PHE4 ...	U 6.6 11 S	U 3.3 33 S
Part No.	783 511	783 533
Nominal voltage (U _N)	6.6 / 11 kV	3.3 ... 11 / 11 ... 33 kV
Total length (l _G)	1030 mm	1720 mm
Insertion depth (l _O)	230 mm	920 mm

PHE III Voltage Detector



PHE III voltage detector with visual and acoustic indicator used for an indoor switchgear installation.

Nominal voltages up to 30 kV / 50 Hz Safe verification of isolation from supply voltage

- Reliable indication
- Easy to use
- Cost-effective / space-saving transport

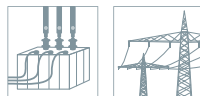

General technical data:

Standard	EN/IEC 61243-1 (DIN VDE 0682-411)
Temperature range	-25 °C ... +55 °C, climatic category N
Design	Complete
For use in wet weather conditions	
For	Indoor and outdoor installations
Indication	Acoustic and visual
Self-testing element	Yes
Material (test electrode)	Copper alloy/gal Sn
Material (test prod)	Glass-fibre reinforced epoxy resin tube
Material (indicator)	Plastic, fully insulated
Material (insulating stick)	Glass-fibre reinforced polyester tube

Nominal Voltages up to 30 kV / 50 Hz, M12 Thread

Category "S" for switchgear installations and overhead lines.



Type PHE3 ...	3 S	6 S
Part No.	767 703	767 706
Nominal voltage (U _N)	3 kV	6 kV
Total length (l _G)	1080 mm	1080 mm
Insertion depth (l _O)	285 mm	285 mm

Type PHE3 ...	10 S	20 S
Part No.	767 710	767 720
Nominal voltage (U _N)	10 kV	20 kV
Total length (l _G)	1080 mm	1230 mm
Insertion depth (l _O)	285 mm	435 mm

Type PHE3 ...	30 S
Part No.	767 730
Nominal voltage (U _N)	30 kV
Total length (l _G)	1415 mm
Insertion depth (l _O)	620 mm

Nominal Voltage Ranges up to 30 kV / 50 Hz, M12 Thread

Category "S" for switchgear installations and overhead lines.



Type PHE3 ...	3 10 S	6 20 S
Part No.	767 711	767 721
Nominal voltage (U _N)	3 ... 10 kV	6 ... 20 kV
Total length (l _G)	1415 mm	1575 mm
Insertion depth (l _O)	620 mm	780 mm

Type PHE3 ...	10 30 S
Part No.	767 731
Nominal voltage (U _N)	10 ... 30 kV
Total length (l _G)	1675 mm
Insertion depth (l _O)	880 mm

Nominal Voltage Ranges up to 30 kV / 50 Hz, M12 Thread, switchable

The nominal voltage selector switch allows to switch between two nominal voltage ranges. For safety reasons, the voltage detector can only be switched on if the selector switch is switched to the most sensitive range of 3 kV to 10 kV. The switch snaps into the relevant position, thus providing protection against inadvertent switching. A magnetically operated, wear-resistant reed switch changes the switching position.



Category "S" for switchgear installations and overhead lines.

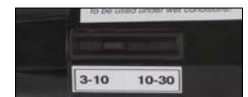

Type PHE3 ...	U 3 30 S
Part No.	767 733
Nominal voltage (U _N)	3 ... 10 / 10 ... 30 kV
Total length (l _G)	1675 mm
Insertion depth (l _O)	880 mm

Nominal Voltage Ranges up to 30 kV / 50 Hz, Test Kit, Thread M12

With two test prods of Category "S" for switchgear installations and overhead lines and of Category "L" for overhead lines.



Type PHE3 ...	6 20 SL	10 30 SL
Part No.	767 740	767 750
Nominal voltage (U _N)	6 ... 20 kV	10 ... 30 kV
Total length (l _G)	1575 / 980 mm	1675 / 980 mm
Insertion depth (l _O)	780 / 185 mm	880 / 185 mm

DEHNproX - 3. Verify that the installation is dead - Voltage detectors

Nominal Voltages up to 30 kV / 50 Hz, Gear Coupling
Category "S" for switchgear installations and overhead lines.



Type PHE3 ...	3 S ZK	6 S ZK
Part No.	767 903	767 906
Nominal voltage (U _N)	3 kV	6 kV
Total length (l _G)	1150 mm	1150 mm
Insertion depth (l _O)	285 mm	285 mm

Type PHE3 ...	10 S ZK	20 S ZK
Part No.	767 910	767 920
Nominal voltage (U _N)	10 kV	20 kV
Total length (l _G)	1150 mm	1300 mm
Insertion depth (l _O)	285 mm	435 mm

Type PHE3 ...	30 S ZK
Part No.	767 930
Nominal voltage (U _N)	30 kV
Total length (l _G)	1485 mm
Insertion depth (l _O)	620 mm

Nominal Voltage Ranges up to 30 kV / 50 Hz, Gear Coupling
Category "S" for switchgear installations and overhead lines.



Type PHE3 ...	3 10 S ZK	6 20 S ZK
Part No.	767 941	767 951
Nominal voltage (U _N)	3 ... 10 kV	6 ... 20 kV
Total length (l _G)	1485 mm	1645 mm
Insertion depth (l _O)	620 mm	780 mm

Type PHE3 ...	10 30 S ZK
Part No.	767 961
Nominal voltage (U _N)	10 ... 30 kV
Total length (l _G)	1745 mm
Insertion depth (l _O)	880 mm

Nominal Voltage Ranges up to 36 kV / 50 Hz, Gear Coupling, switchable



The nominal voltage selector switch allows to switch between two nominal voltage ranges. For safety reasons, the voltage detector can only be switched on if the selector switch is switched to the most sensitive range of (3 kV to 10 kV or 6 kV to 20 kV). The switch snaps into the relevant position, thus providing protection against inadvertent switching. A magnetically operated, wear-resistant reed switch changes the switching position.

Category "S" for switchgear installations and overhead lines.

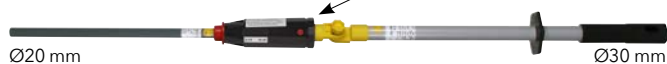
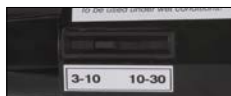

Type PHE3 ...	U 3 30 S ZK	U 6 36 S SN7728
Part No.	767 960	767 944
Nominal voltage (U _N)	3 ... 10 / 10 ... 30 kV	6 ... 20 / 20 ... 36 kV
Total length (l _G)	1745 mm	1745 mm
Insertion depth (l _O)	880 mm	880 mm

Nominal Voltage Ranges up to 30 kV / 50 Hz, Test Kit, Gear Coupling



With two test prods of Category "S" for switchgear installations and overhead lines and of Category "L" for overhead lines.



Type PHE3 ...	6 20 SL ZK	10 30 SL ZK
Part No.	767 940	767 950
Nominal voltage (U _N)	6 ... 20 kV	10 ... 30 kV
Total length (l _G)	1650 / 1050 mm	1750 / 1050 mm
Insertion depth (l _O)	780 / 185 mm	880 / 185 mm

PHE III ZK Indicator with Test Prod



PHE III indicator with test prod, universal gear coupling and insulating stick.

Nominal voltages up to 30 kV / 50 Hz
Safe verification of isolation from supply voltage

- Reliable indication with standby function
- Easy to use
- Cost-effective / space-saving transport

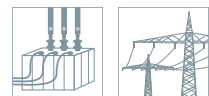

General technical data:

Standard (indicator with test prod)	EN/IEC 61243-1 (DIN VDE 0682-411)
Standard (universal gear coupling)	EN/IEC 60832 (DIN VDE 0682-211)
Temperature range	-25 °C ... +55 °C, climatic category N
Design	Separate
For use in wet weather conditions	
For	Indoor and outdoor installations
Indication	Acoustic and visual
Self-testing element	Yes
Material (test electrode)	Copper alloy/gal Sn
Material (test prod)	Glass-fibre reinforced epoxy resin tube
Material (indicator)	Plastic, fully insulated

Standby function

The PHE III indicator with test prod has a standby function meaning that the device is automatically activated as soon as contact with energised equipment is made (without previous self-test) and visually and acoustically indicates "voltage present". When making contact with de-energised equipment, the indicator is not activated.

Attention

The PHE III indicator with test prod may only be used in combination with a suitably rated insulating stick.

DEHNproX - 3. Verify that the installation is dead - Voltage detectors

Nominal Voltage Ranges up to 30 kV / 50 Hz, Category "S"
Category "S" for switchgear installations and overhead lines.



Type PHE3 ...	PK6 20 S SB ZK	PK10 30 S SB ZK
Part No.	767 921	767 931
Nominal voltage (U _N)	6 ... 20 kV	10 ... 30 kV
Total length (l _G)	1010 mm	1110 mm
Insertion depth (l _O)	780 mm	880 mm

Nominal Voltage Ranges up to 30 kV / 50 Hz, Category "L"
Category "L" for overhead lines.



Type PHE3 ...	PK6 20 L SB ZK	PK10 30 L SB ZK
Part No.	767 922	767 932
Nominal voltage (U _N)	6 ... 20 kV	10 ... 30 kV
Total length (l _G)	415 mm	415 mm
Insertion depth (l _O)	185 mm	185 mm

Accessories for PHE III ZK Indicator with Test Prod

Insulating stick for PHE4 and PHE III with universal gear coupling
Handle end fitting with plastic plug-in coupling as extension handle.



Type	IS ZK STK 670
Part No.	766 368
Total length (l _G)	670 mm
Length (handle) (l _H)	265 mm
Diameter	30 mm
Material	Glass-fibre reinforced polyester tube

Telescopic insulating stick, with universal gear coupling

With scale for measuring the ground clearance, mounted support included.

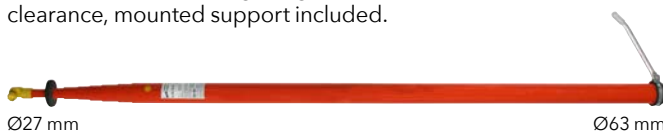

Type	ISMTC N 36 ZK 10600
Part No.	766 037
Nominal voltage (U _N)	Up to 36 kV
Total length (l _{G max} / l _{G min})	10,600 / 1750 mm
Length (handle) (l _{H min})	1680 mm
Material	Glass-fibre reinforced epoxy resin tube

PHG II Voltage Detector



PHG II voltage detector used in a type-tested switchgear installation.

Nominal voltages up to 20 kV / 50 Hz
Easy and safe testing

- Cost-effective
- Reliable indication



General technical data:

Standard	EN/IEC 61243-1 (DIN VDE 0682-411)
Temperature range	-25 °C ... +55 °C, climatic category N
Design	Complete
Only for indoor installations	
For	Indoor installations
Indication	Visual, 3 LEDs
Function	Passive voltage detector without batteries
Material (test electrode)	Cu/gal Sn
Material (test prod)	Glass-fibre reinforced polyester tube
Material (indicator)	Plastic
Material (insulating stick)	Glass-fibre reinforced polyester tube

Test for correct operation:

The EN 50110-1 (DIN VDE 0105-100) standard requires that voltage detectors be tested for correct operation directly before and after they are used.

Voltage detectors without self-testing element must be tested for correct operation by contacting parts of the installation connected to operating voltage.

On the test prod of the voltage detector there is a fork-shaped electrode.

Nominal Voltages up to 20 kV / 50 Hz

Category "S" for indoor switchgear installations.



General technical data:

Total length (l _G)	1425 mm
Insertion depth (l _O)	720 mm

Type PHG2 ...	6	10
Part No.	766 706	766 710
Nominal voltage (U _N)	6 kV	10 kV

Type PHG2 ...	20
Part No.	766 720
Nominal voltage (U _N)	20 kV

PHE III Voltage Detector Kit



PHE III voltage detector used on a 110 kV outdoor station.

Nominal Voltage Range

60 ... 110 kV / 50 Hz

Category "S" for switchgear installations and overhead lines.

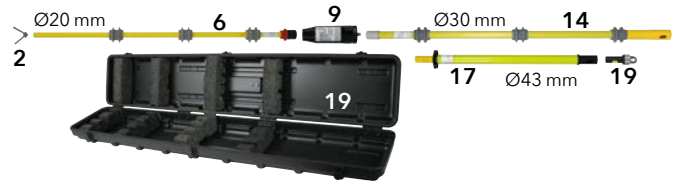

Type	PHE3S2 60 110 S
Part No.	767 980
Nominal voltage (U _N)	60 ... 110 kV
Total length (l _G)	2980 mm
Insertion depth (l ₀)	880 mm

Nominal voltage 20 and 60 ... 110 kV / 50 Hz Safe verification of isolation from supply voltage

- Reliable indication
- Easy to use
- Multi-purpose kit
- Cost-effective / space-saving transport

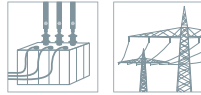

General technical data:

Standard	EN/IEC 61243-1 (DIN VDE 0682-411)
Temperature range	-25 °C ... +55 °C, climatic category N
Design	Complete
For use in wet weather conditions	
For	Indoor and outdoor installations
Indication	Acoustic and visual
Self-testing element	Yes
Material (test electrode)	Copper alloy/gal Sn
Material (test prod)	Glass-fibre reinforced epoxy resin tube
Material (indicator)	Plastic, fully insulated
Material (insulating stick)	Glass-fibre reinforced polyester tube

Parts list:

No.	Part No.	No.	Part No.
1	766 927	11	766 335
2	766 924	12	766 115
3	766 960	13	766 116
4	767 763	14	766 117
5	767 771	15	766 120
6	769 701	16	766 077
7	767 722	17	766 889
8	767 734	18	767 996
9	769 713	19	766 998
10	766 368		

For more detailed information on these products, see * www.dehn-international.com.

Nominal Voltage Range

60 ... 110 kV / 50 Hz CODED

Special test prod and indicator are mutually coded, i.e. no other test prod fits mechanically for the used indicator. Thus confusion of test prods is avoided.



Category "S" for switchgear installations and overhead lines as coded type.

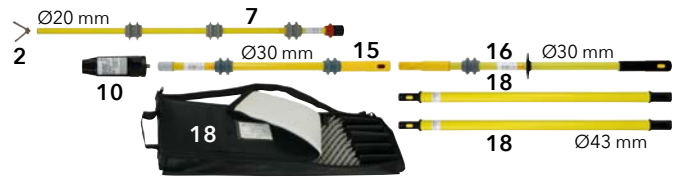

Type	PHE3S60 110S CSN7774
Part No.	769 712
Nominal voltage (U _N)	60 ... 110 kV
Total length (l _{G max} / l _{G min})	4470 / 2840 mm
Insertion depth (l ₀)	880 mm

Nominal Voltage 20 kV / 50 Hz

Category "S" for switchgear installations and overhead lines.



Possible lengths:

Length l _G (mm)	Insertion depth l ₀ (mm)	Pos. No.
3080	1580	1+3+4 +7+10 +11
2290	800	1+4+7 +10+11
1660	800	1+4+7 +10



Type	PHE3S 20 S ZK
Part No.	767 724
Nominal voltage (U _N)	20 kV
Total length (l _{G max})	3080 mm
Insertion depth (l _{0 max})	1580 mm

ASP Non-Contact Voltage Detector Kit



Use of an ASP distance voltage detector in an outdoor switching station.

Nominal voltage range 110 ... 420 kV / 16.7 and 50 Hz

Easy and safe testing

- Easy to use due to compact design
- Cost-effective / space-saving transport



General technical data:

Temperature range	-25 °C ... +55 °C
For use in wet weather conditions	
For	Overhead lines and outdoor switching stations
Indication	Acoustic and visual
Self-testing element	Yes
Material (indicator)	Plastic, fully insulated, black
Material (electric field sensor)	Plastic, black
Material (insulating stick)	Glass-fibre reinforced polyester tube

Parts list:

No.Part No.	No.Part No.
1 767 576	5 767 593
2 767 577	6 766 369
3 767 591	7 767 574
4 767 592	8 767 996

For more detailed information on these products, see * www.dehn-international.com.

Category „S” and „L”

Devices of category „S” may only be used in outdoor switching stations, devices of category „L” for overhead lines only. Devices of category „S” / „L” may be used both for outdoor switching stations and overhead lines.

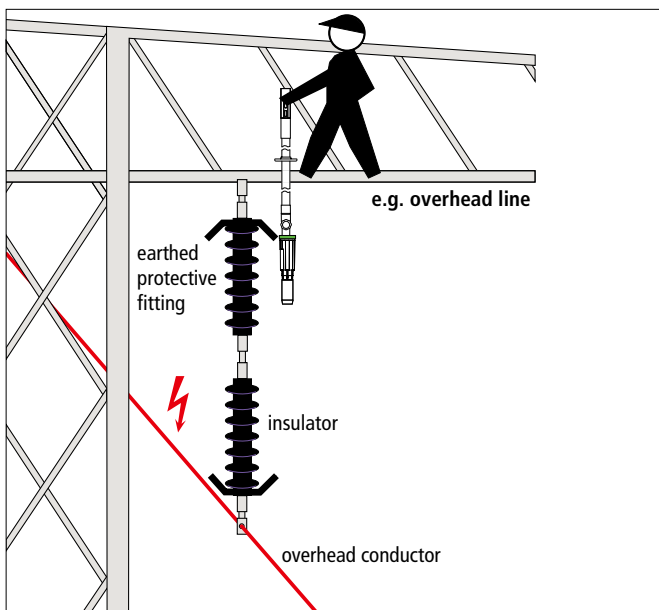

Use for overhead lines

The green ring on the ASP distance voltage detector with category „L” electric field sensor is used to make contact with the last earthed protective fitting in such a way that the electric field sensor points in the direction of the overhead conductor fixed at the other end of the insulator.

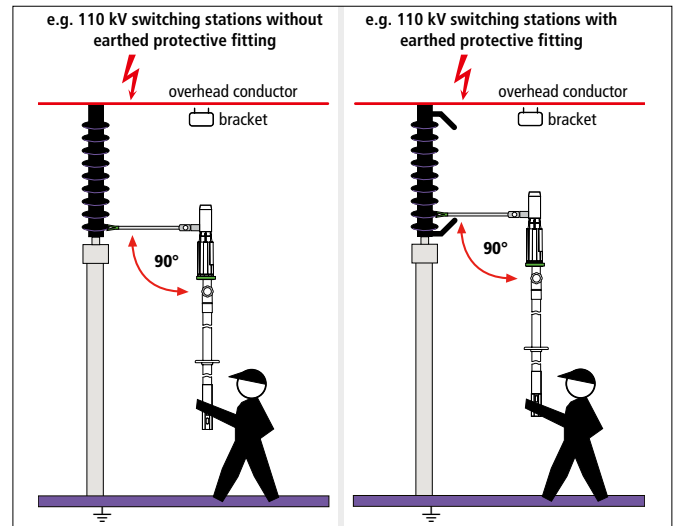

Use in outdoor switching stations

The green ring on the arm of the ASP distance voltage detector with category „S” electric field sensor is used to make contact with the lowest insulator plate at a right angle.

If an earthed protective fitting is available, contact is made at the next possible insulator plate above the protective fitting.

Category „L”, 50 Hz

Category „L” for overhead lines in accordance with the DIN VDE V 0682-417/10.2013 preliminary standard.

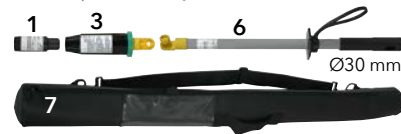

Type	ASPS 110 420 L
Part No.	767 571
Nominal voltage (U _N)	110 ... 420 kV
Frequency	50 Hz
Total length (l _G)	960 mm

Category „S”, 50 Hz

Category „S” for outdoor switching stations.

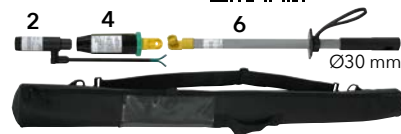

Type	ASPS 110 420 S	ASP 110 420 S
Part No.	767 572	767 582
Nominal voltage (U _N)	110 ... 420 kV	110 ... 420 kV
Frequency	50 Hz	50 Hz
Total length (l _G)	1000 mm	1000 mm

Category „S / L”, 50 Hz

Category „S / L” for overhead lines and outdoor switching stations.

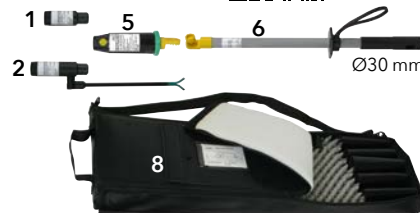

Type	ASPS 110 420 S L
Part No.	767 573
Nominal voltage (U _N)	110 ... 420 kV
Frequency	50 Hz
Total length (l _G)	1000 mm

HSA 194 High-Voltage Indicator



High-voltage indicator used on a 110 kV overhead line.

Nominal voltage range 110 ... 420 kV / 16.7 and 50 Hz

Easy and safe testing

- For contactlessly verifying that switchgear and high-voltage overhead lines or centre-earthed monophasic traction power lines are dead
- Cost-effective / space-saving transport

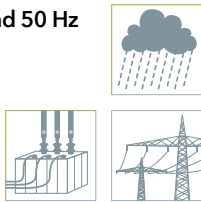

Special instructions for the use of HSA 194 110 420 SN7737 (Part No. 767539)

The device can be switched between the „climbing check“ mode (switch position when climbing the tower) and the „110 ... 420 kV“ mode for verifying that the overhead conductor is dead.

Switch position „climbing check“

When climbing the lattice tower, the switch position „climbing check“ allows to check from the corner leg whether the next overhead conductor (or conductor bundle) is still energised when approaching it. During this check, the high-voltage indicator is moved closer towards the next overhead conductor and moved within 0.5 m (see Fig. 1). If the conductor is energised, there is a visual (red flashing light) and acoustic signal. The **minimum distance A (min)** (according to the nominal voltage in Table 2) between the operating head of the high-voltage indicator and the overhead conductor must be observed. The customer must determine the maximum distance A (max) (safe tripping of the high-voltage indicator when approaching the overhead conductor) depending on the nominal voltage and document it in the operating instructions.

Using the high-voltage indicator when climbing lattice towers does not replace verifying absence of voltage from the cross arm.

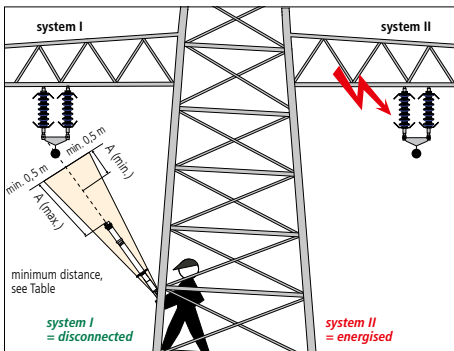

Figure 1: Example of application on the corner leg of a lattice tower with switch position „climbing check“ (only HSA 194 110 420 SN7737)

Nominal voltage	Min safety distance A (min.)
110 kV	2000 mm
220 kV	3000 mm
380 kV	4000 mm
420 kV	4400 mm

Table 2

General technical data:

Temperature range	- 25 °C ... + 55 °C, climatic category N
For use in wet weather conditions	
Indication	Acoustic and visual
Self-testing element	Yes
Material (insulating stick)	Glass-fibre reinforced polyester tube

General application notes for the HSA 194

Switch position voltage range „110 ... 420 kV“

To verify absence of voltage from the tower cross arm, place the green ring of the high-voltage indicator on the last earthed protective fitting (or earthed insulator cap) of the insulator so that the operating head of the high-voltage indicator (see Fig. 2) points towards the overhead conductor to be tested, which is attached to the other insulator end (longitudinal axis of the device in parallel to the longitudinal axis of the insulator). If the conductor is energised, there is a visual (red flashing light) and acoustic signal.

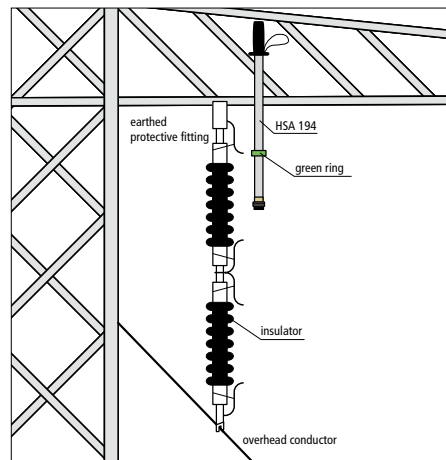

Figure 2: Example of application on the tower cross arm with switch position „110 ... 420 kV“

Nominal Voltage Range 110 ... 420 kV

With plug-in coupling as end fitting for extending the handle. Storage bag included in delivery.



Type	HSA194 110 420 STK
Part No.	767 541
Nominal voltage range (U _N)	110 ... 420 kV
Frequency	50 Hz
Total length (l _G)	940 mm
Insulating clearance (l _I)	540 mm
Verification while climbing the tower	No

Nominal Voltage Range 110 ... 420 kV, with verification while climbing the tower

With plug-in coupling as end fitting for extending the handle. Storage bag included in delivery.



Type HSA 194 ...	110 420 SN7737
Part No.	767 539
Nominal voltage range (U _N)	110 ... 420 kV
Frequency	50 Hz
Total length (l _G)	940 mm
Insulating clearance (l _I)	540 mm
Verification while climbing the tower	Yes

HSA 205 High-Voltage Indicator



HSA 205 high-voltage indicator with insulating cap used on a switchgear installation.

Nominal voltage range 1 ... 420 kV / 50 or 60 Hz

- For contactlessly verifying that switchgear installations and high-voltage overhead lines are dead
- Wide nominal voltage range

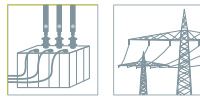

General technical data:

Temperature range	-25 °C ... +55 °C, climatic category N
For use in wet weather conditions	
Indication	Visual and acoustic
Self-testing element	Yes
Material (insulating stick)	Glass-fibre reinforced polyester tube

Nominal Voltage Ranges up to 420 kV, switchable

With insulating cap and plug-in coupling as end fitting for extending the handle. Storage bag included in delivery.



Type HSA205 U 1 ...	420 STK	420SN7608
Part No.	767 552	767 547
Nominal voltage range (U _N)	1 ... 30 / 30 ... 220 / 110 ... 420 kV	1 ... 30 / 30 ... 220 / 110 ... 420 kV
Frequency	50 Hz	60 Hz
Total length (l _G)	950 mm	950 mm
Insulating clearance (l _i)	540 mm	540 mm

Application notes

The operating head of HSA 205 high-voltage indicator is fitted with a yellow switching ring, which is used to set the required nominal voltage range, either 1 to 30 kV, 30 to 220 kV or 110 to 420 kV. The transparent insulating cap must be used in the voltage range from 1 to 30 kV. Provided that the insulating tube and cap of the high-voltage indicator are in a dry and clean condition, the minimum distance A can be reduced for nominal voltages up to 30 kV. If these conditions cannot be ensured, the minimum distance A must be maintained!

Minimum distances A according to nominal voltage:

Selected voltage range	Nominal voltage acc. to DIN VDE 0105 Part 1	Min. safety distance A DIN VDE 0105 Part 1
Red 1 ... 30 kV	over 1 up to 6 kV	90 mm indoor installations
	over 6 up to 10 kV	120 mm indoor installations
	over 1 up to 10 kV	150 mm outdoor installations
	over 10 up to 20 kV	220 mm indoor and outdoor installations
White 30 ... 220 kV	over 20 up to 30 kV	320 mm indoor and outdoor installations
	over 30 up to 45 kV	480 mm indoor and outdoor installations
	over 45 up to 60 kV	630 mm indoor and outdoor installations
Yellow 110 ... 420 kV	over 60 up to 110 kV	1100 mm indoor and outdoor installations
	over 110 up to 220 kV	2100 mm indoor and outdoor installations
	over 110 up to 220 kV	2100 mm indoor and outdoor installations
	over 220 up to 420 kV	2900/3400 mm indoor and outdoor installations

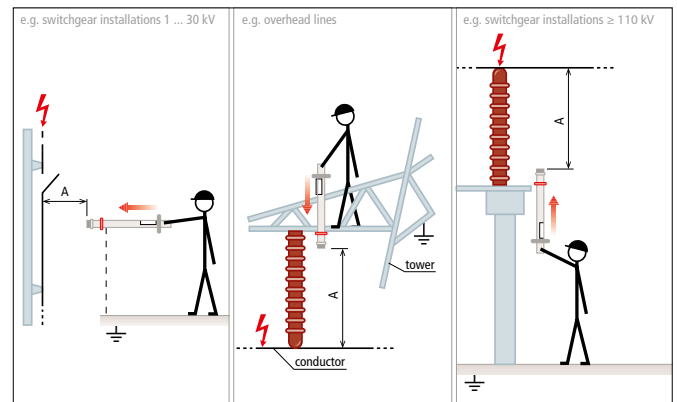

PHE/G DC Voltage Detector



PHE/G II DC voltage detector for DC links (ICE power car).

Nominal voltages up to 24 kV DC

Safe verification of isolation from supply voltage

- For use in direct voltage systems (electrified rail networks, DC links)
- Reliable indication
- Easy to use due to compact design
- User-friendly

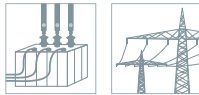

The test prod of DC voltage detectors is colour-coded according to the polarity of the test prod:

- positive pole - red;
- negative pole - blue.

General technical data:

Standard	Based on EN/IEC 61243-1 (DIN VDE 0682-411)
Temperature range	-25 °C ... +55 °C, climatic category N
For use in wet weather conditions	
For	Indoor and outdoor installations
Indication	Visual
Self-testing element	Yes
Material (test prod)	Glass-fibre reinforced polyester tube
Material (indicator)	Plastic, fully insulated
Material (insulating stick)	Glass-fibre reinforced polyester tube
Material (earthing / connecting cable)	Copper cable, highly flexible

PHE/G I for Switchgear Installations, positive pole on indicator with test prod



One stick

- For direct voltage systems with earthed negative pole
- Positive pole: indicator with test prod
- Negative pole: earth clamp with magnet



Type	PHEG1.S P SN7401
Part No.	767 666
Threshold voltage (U _t)	120 V
Nominal voltage (U _N)	1 ... 24 kV
Length (earthing cable)	2000 mm
Total length (l _G)	1260 mm
Insertion depth (l ₀)	535 mm

PHE/G I for Switchgear Installations, positive pole on indicator with test prod, angled

One stick

- For direct voltage systems with earthed negative pole
- Positive pole: Indicator with test prod
- Negative pole: Earth clamp



Type	PHEG1 S P SN7240
Part No.	767 636
Threshold voltage (U _t)	60 V
Nominal voltage (U _N)	3.8 kV
Length (earthing cable)	4000 mm
Total length (l _G)	1100 mm

PHE/G II for Switchgear Installations

Two sticks

- For unearthed direct voltage installations
- For DC links
- Positive pole: Indicator with test prod
- Negative pole: Insulating stick



Type	PHEG2.P SN7517
Part No.	767 671
Threshold voltage (U _t)	90 V
Nominal voltage (U _N)	1 ... 24 kV
Length (connecting cable)	1200 mm
Total length (l _G)	1260 mm
Insertion depth (l ₀)	545 mm

PHE/G II for Switchgear Installations and DC Links

Two sticks

- For unearthed direct voltage installations
- For DC links (e.g. electric locomotives; Part No. 767 647)
- Positive pole: Indicator with test prod
- Negative pole: Insulating stick



General technical data:

Length (connecting cable)	1200 mm
---------------------------	---------

Type	PHEG2 P SN7552	PHEG2 P SN7259
Part No.	767 647	767 645
Threshold voltage (U _t)	90 V	120 V
Nominal voltage (U _N)	1 ... 4.2 kV	1 ... 12 kV
Total length (l _G)	600 mm	1085 mm

Type	PHEG2 P SN7407	PHEG2 P SN7194
Part No.	767 640	767 637
Threshold voltage (U _t)	350 V	750 V
Nominal voltage (U _N)	600 ... 750 V	1.5 kV
Total length (l _G)	1085 mm	1085 mm

Two-pole SPN voltage detector for power supply



Two-pole SPN voltage detector used with extension prods for overhead lines.

Nominal voltages up to 1000 V

- Extremely shock-resistant, waterproof and dust-proof enclosure
- Test ball with additional phase, rotation field and continuity test
- Two versions with different measuring ranges
- For use in overhead line networks by attaching extension prods
- No battery required



General technical data:

Standard	EN/IEC 61243-3 (DIN VDE 0682-401)
Temperature range	-15 °C ... +45 °C
Degree of protection	IP 65
For use in wet weather conditions	
Material (indicator)	Safety enclosure made of solid rubber
Indication	Direct-reading instrument, LCD and LED
Connecting cable	PUR-sheathed cable, highly flexible, 1000 mm
Overvoltage category	SPN 500B: CAT IV 500 V; SPN 1000B: CAT IV 1000 V

Nominal Voltage Range up to 1000 V

Basic devices.



Type SPN ...	500B	1000B
Part No.	766 660	766 665
Nominal voltage range (U _N)	50 ... 500 V	50 ... 1000 V
Frequency range	15 ... 500 Hz and DC	15 ... 500 Hz and DC
Dimensions (indicator)	274 x 75 x 47 mm	274 x 75 x 47 mm

Accessories for Two-pole SPN voltage detector for power supply

Extension prod

For use in overhead line networks, to be screwed onto the basic device.



Type	VS 500 SPN II
Part No.	766 542
Length	500 mm

Artificial leather bag, empty

For SPN voltage detectors (basic device with extension prods).



Type	AT SPN II
Part No.	766 543
Dimensions	535 x 160 mm
Colour	Black ●

Two-pole SPN voltage detector for the electrical trade and industry



Testing the high DC voltage of a HV electric vehicle.

- Direct display system with low stress on the test point
- Switchable vibration motor
- Ideal for voltage testing on photovoltaic and wind power plants; on hybrid vehicles; on high system voltages in industry; in service and in trades

General technical data:

Standard	EN 61243-3 (VDE 0682-401)
Degree of protection	IP 65
Overvoltage category	CAT IV 600 V

Nominal voltage range
1 to 1000 V AC / 1200 DC,
digital



Type SPN ...	1200 D
Part No.	700 102 <small>NEW</small>
Indicator	LED/LCD (lights up)
Voltage range	1.0 V - 1000 V AC / 1200 V DC
Frequency measurement range	1 - 1000 Hz
Acoustic and visual continuity test	Buzzer + yellow LED 0 - 100 kΩ
Diode test	0.3 - 2.0 V
Resistance measuring range	0.1 kΩ - 300 kΩ
Rotating field test	Green LEDs (right/left)
Single-pole line conductor test (phase)	Red "flash" LED
Polarity test	LCD (+/-)
Cable break detector	Yellow LED (flashing)
Load switching via pushbutton	I _S = 550 mA (1000 V) 30 mA RCD trip
Vibration alarm	yes
Measuring point lighting	White LED

Nominal voltage range
12 to 1,000 V AC/DC,
analogue



Type SPN ...	1000 A
Part No.	700 100 <small>NEW</small>
Indicator	Plunger coil (illuminated)/LED
Voltage range	12 V - 1000 V AC/DC
Frequency measurement range	-
Acoustic and visual continuity test	-
Diode test	-
Resistance measuring range	-
Rotating field test	LCD (R icon)
Single-pole line conductor test (phase)	LCD (R icon)
Polarity test	LED (+/-)
Cable break detector	-
Load switching via pushbutton	I _S = 550 mA (1000 V) 30 mA RCD trip
Vibration alarm	yes
Measuring point lighting	-

Structure of phase comparators

Phase comparators in accordance with EN/IEC 61481-1 (DIN VDE 0682-431-1) are designed for testing for in-phase condition of three-phase systems.

Only electrically skilled or instructed persons are allowed to test for in-phase condition. Phase comparators have to be tested for correct operation immediately before and after use.

Phase comparators without self-testing element have to be tested for correct operation by making contact with a part of the installation connected to operating voltage. Testing for in-phase condition by means of a phase comparator is considered live working. Phase comparators may only be used for the nominal voltages / nominal voltage ranges as indicated on the rating plate. The user may be at risk if the voltage detector is used for voltages other than indicated on the rating plate (incorrect indication, electric shock, arcing).

Phase comparators labelled "For indoor and outdoor installations" must not be used in wet weather conditions.

Phase comparators labelled "Also suitable for use in wet weather conditions" may be used in all weather conditions such as rain, snow, fog and dew. Phase comparators in accordance with IEC/EN 61481-1 (DIN VDE 0682-431-1) are only suitable to a limited extent for use in factory assembled (type-tested) installations.

When inserting the test prod, flashovers may occur due to the restricted space in these installations. The user of the phase comparator or the operator of the switchgear must ask the manufacturer of the type-tested equipment whether the existing phase comparator may be used.

Structure of phase comparators

Phase comparators can be designed as a two-pole device (resistive phase comparator) in accordance with IEC/EN 61481-2 (DIN VDE 0682-431-2) or as a single-pole device (capacitive phase comparator) in accordance with IEC/EN 61481-1 (DIN VDE 0682-431-1). The structure of the PHV I single-pole phase comparator is similar to that of a capacitive voltage detector. The functional principle of single-pole phase comparator is based on a microprocessor controlled electronic storage system.

Single-pole phase comparators consist of a handle with hand guard, insulating element, indicator and test prod with contact electrode.

The **insulating element** is the section of a phase comparator between the hand guard and the red ring. It ensures that the user maintains an adequate safety distance for safe operation.

The **test prod** with a contact electrode above the red ring makes it possible to reach remote parts of the installation and to eliminate the influence of interference fields.

The **hand guard** is a clearly visible and tangible barrier between the handle and the insulating element. It prevents the user's hand from slipping off the handle and making accidental contact with the insulating element.

The **red ring** marks the end of the insulating element towards the test electrode. It provides the user with a visible limitation for contact with live parts of the installation. The insulating clearance between the red ring and hand guard must not contact live parts, but contact with earthed parts is allowed.

The **test electrode** is part of the phase comparator which is used to make contact with the uninsulated part of the installation to be tested.

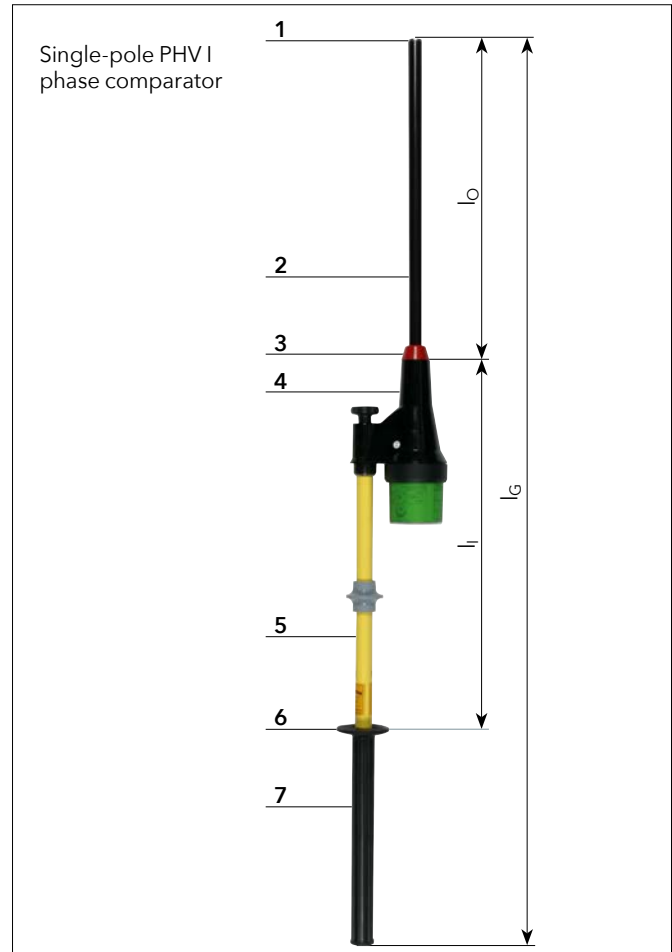

- 1 Test electrode
- 2 Test prod
- 3 Red ring
- 4 Indicator
- 5 Insulating element
- 6 Hand guard
- 7 Handle

- l_G Total length of the phase comparator
- l_0 Length of the top section
- l_1 Length of the insulating element

Storage bags and transport cases

- Cases: Sheet steel or plastic
- Bags: Artificial leather or canvas



55
56

German Social Accident Insurance (DGUV) Regulation 3 (formerly accident prevention regulations (BGV A3))

Phase comparators must be checked according to the DGUV regulation 3 (previously BGV A3) for compliance with the limit values as specified in the electrotechnical rules. This test is carried out in the high-voltage test laboratory at DEHN and includes, among other things:

- Testing the discharge current
- Testing for clear indication
- Testing the protection against bridging
- Testing by visual inspection, manual test and measuring

The maintenance test is documented in a test report and on the device itself.

The intervals for maintenance tests of phase comparators depend on their conditions of use, e.g. frequency of use, stress due to environmental conditions and transport, etc, however, according to DGUV regulation 3, **at least every 6 years**.



7

Single-pole PHV I Phase Comparator



Single-pole PHV I phase comparator used in a switchgear installation.

Nominal voltages up to 36 kV / 50 Hz

Safe testing

- Reliable indication



General technical data:

Standard	EN/IEC 61481-1 (DIN VDE 0682-431-1)
Temperature range	-25 °C ... +55 °C, climatic category N
For use in wet weather conditions	
For	Indoor and outdoor installations
Self-testing element	Yes
Material (test prod)	Plastic
Material (indicator)	Plastic, fully insulated
Material (insulating stick)	Glass-fibre reinforced polyester tube

Nominal Voltage Ranges up to 36 kV / 50 Hz



Type PHV1P ...	6 12	10 20
Part No.	759 706	759 712
Nominal voltage (U _N)	6 ... 12 kV	10 ... 20 kV
Total length (l _G)	1270 mm	1270 mm
Insertion depth (l _O)	450 mm	450 mm

Type PHV1P ...	20 36
Part No.	759 736
Nominal voltage (U _N)	20 ... 36 kV
Total length (l _G)	1730 mm
Insertion depth (l _O)	910 mm

Nominal Voltage Ranges up to 36 kV / 50 Hz, switchable



Type PHV1P ...	U 5 36
Part No.	759 716
Nominal voltage (U _N)	5 ... 10 / 20 ... 36 kV
Total length (l _G)	1730 mm
Insertion depth (l _O)	910 mm

Application, indication	Nominal voltage U_N / Frequency f_N	Product	Page
DEHNcap/P voltage indicator / DEHNcap/P test unit			
<ul style="list-style-type: none"> Passive indicator without batteries LED display Also suitable for use as permanent voltage indicator 	up to 45 kV / 50 Hz		50
<ul style="list-style-type: none"> For simple functional test Simple operation on a 230 V socket outlet For HR and LRM indicators 	230 V / 50 Hz		
DEHNcap/A voltage indicator			
<ul style="list-style-type: none"> Active voltage indicator Indication via two separate LEDs With self-testing element and battery monitoring device Automatic deactivation after use 	up to 45 kV / 50 Hz		51
DEHNcap/IT interface test unit			
<ul style="list-style-type: none"> Active indicator for maintenance tests Indication via two separate LEDs With self-testing element and battery monitoring device Automatic deactivation after use 	up to 45 kV / 50 Hz		51
DEHNcap HR-LRM test set			
<ul style="list-style-type: none"> Complete test set 	up to 45 kV / 50 Hz		52
DEHNcap/PC phase comparator			
<ul style="list-style-type: none"> Active indicator for testing in-phase conditions Indication via three separate LEDs Can be used at HR test sockets with two HR-LRM test adapters Comparator detects zero crossings of the systems to be compared With battery monitoring function 	up to 45 kV / 50 Hz		52
DEHNcap test adapter			
<ul style="list-style-type: none"> HR-LRM test adapter LR-LRM test adapter 			53
German Social Accident Insurance (DGUV) Regulation 3 (formerly accident prevention regulations (BGV A3))			
<p>Capacitive voltage detecting systems must be checked according to the DGUV regulation 3 (previously BGV A3) for compliance with the limit values as specified in the electrotechnical rules. This test is carried out in the high-voltage test laboratory at DEHN.</p> <p>The maintenance test is documented in a test report and on the device itself.</p> <p>The intervals for maintenance tests of capacitive voltage detecting systems depend on their conditions of use, e.g. frequency of use, stress due to environmental conditions and transport, etc, however, according to DGUV regulation 3, at least every 6 years.</p>			7



DEHNcap/P Voltage Indicator



DEHNcap/P passive voltage indicator used in an encapsulated switchgear installation.

Nominal voltages up to 45 kV / 50 Hz
Easy verification of isolation from supply voltage

- Cost-effective

General technical data:	
Standard	EN/IEC 61243-5 (DIN VDE 0682-415)
Temperature range	-25 °C ... +55 °C
Degree of protection	IP 66
Type of device	Voltage indicator
Use	Can also be used as permanent voltage indicator

Test for correct operation

EN 50110-1 (DIN VDE 0105-100) requires that voltage indicators be tested for correct operation shortly before and after use. Passive indicators without self-testing element must be tested for correct operation by plugging them into test sockets connected to operating voltage or into a test unit (DEHNcap/P test unit).

DEHNcap/P-HR



Type SAG DCA P ...	HR GA
Part No.	767 101
Dimensions	40 x 48 x 35 mm
Plug spacing	19 mm
Indication threshold (HR system)	90 V
Input impedance (HR system)	36 MOhms

DEHNcap/P-LRM



Type SAG DCA P ...	LRM GA
Part No.	767 102
Dimensions	40 x 48 x 35 mm
Plug spacing	14 mm
Indication threshold (LRM system)	5 V
Input impedance (LRM system)	2 MOhms

Accessories for DEHNcap/P Voltage Indicator

Test unit for DEHNcap/P



Type	TG DCA
Part No.	767 110
Nominal voltage (U _N)	230 V
Frequency	50 Hz
Nominal capacity	500 mW
Max. short-circuit current at the test socket	Approx. 20 μA
Dimensions	43 x 75 x 35 mm

Electrical and mechanical interface requirements for pluggable HR, LR and LRM voltage detecting systems

System description		HR high resistance	LR low resistance	LRM low resistance, modified
Input impedance of the indicator	X _C	36 MΩ	2 MΩ	2 MΩ
Electrical response conditions of the interface	I	2.5 μA	2.5 μA	2.5 μA
Electrical response conditions of the interface	U	90 V	5 V	5 V
Socket arrangement and minimum spare area A for indicator or plug				
	Plug arrangement			

DEHNcap/A Voltage Indicator



Self-test of a DEHNcap/A voltage indicator.

Nominal voltages up to 45 kV / 50 Hz
Safe verification of isolation from supply voltage

- User-friendly
- Easy application

General technical data:

Standard	EN/IEC 61243-5 (DIN VDE 0682-415)
Temperature range	- 25 °C ... + 55 °C
Field of application	Active voltage indicator for testing
Self-testing element	Yes

Self-testing element

DEHNcap/A electronic voltage indicators have an integrated self-testing element. By simply pressing the test button, the electronic circuit is tested for correct operation. The self-test is automatically performed as soon as the indicator is switched on. The voltage indicator is only operational if the test button is pressed, i.e. the function test was performed successfully.

DEHNcap/A-LRM



Type	SAG DCA A LRM
Part No.	767 112
Dimensions	120 x 60 x 25 mm
Plug spacing	14 mm
Type of plug	2 multilam plugs (Ø4 mm)
Indication threshold (LRM system)	5 V
Input impedance (LRM system)	2 MOhms

DEHNcap/IT Interface Test Unit



DEHNcap/IT interface test unit allows to carry out maintenance tests on coupling systems of switchgear installations according to IEC/EN 61243-5 (DIN VDE 0682-415).

Nominal voltages up to 45 kV / 50 Hz
Easy and safe testing

- User-friendly
- Easy handling

General technical data:

Standard	EN/IEC 61243-5 (DIN VDE 0682-415)
Temperature range	- 25 °C ... + 55 °C
Field of application	Active indicator for maintenance tests on coupling systems
Self-testing element	Yes

Self-testing element

The DEHNcap/IT interface test unit has an integrated self-testing element. By simply pressing the test button, the electronic circuit is tested for correct operation. The self-test is automatically performed as soon as the indicator is switched on. The interface test unit is only operational if the test button is pressed i.e. the function test was performed successfully.

DEHNcap/IT-LRM



Type	SPG DCA IT LRM
Part No.	767 122
Dimensions	120 x 60 x 25 mm
Plug spacing	14 mm
Type of plug	2 multilam plugs (Ø4 mm)
Input impedance (LRM system)	2 MOhms
Test threshold	3.2 µA

DEHNcap HR-LRM Test Kit



Kit in a plastic case for verifying that the installation is dead and testing the interface as well as for in-phase conditions in HR and LRM systems.

Nominal voltages up to 45 kV / 50 Hz

Easy and safe testing

- Complete test kit for universal use
- Easy operation

General technical data:

Standard	EN/IEC 61243-5 (DIN VDE 0682-415)
Temperature range	-25 °C ... +55 °C

DEHNcap HR-LRM Test Kit



Kit includes:

No.	Part No.	No.	Part No.
1	767 112 (1x)	4	767 133 (2x)
2	767 122 (1x)	5	767 107 (1x)
3	767 132 (1x)		

For more detailed information on these products, see Accessories chapter.

Type	PS DCA HR LRM
Part No.	767 150
Dimensions	395 x 295 x 105 mm

DEHNcap/PC-LRM Phase Comparator



DEHNcap/PC-LRM phase comparator with two HR-LRM test adapters used in an HR switchgear installation.

Nominal voltages up to 45 kV / 50 Hz

Easy and safe testing

- User-friendly
- Easy handling

General technical data:

Standard	EN/IEC 61243-5 (DIN VDE 0682-415)
Temperature range	-25 °C ... +55 °C
Design	Active indicator for testing for in-phase conditions on LRM test sockets
Field of application	For HR test sockets with two HR-LRM test adapters
Self-testing element	Yes

By attaching two optional HR-LRM adapters (Part No. 767 133), the DEHNcap/PC-LRM phase comparator can also be used for phase comparison in HR systems. DEHNcap/PC-LRM is designed as a universal phase comparator in accordance with EN/IEC 61243-5 (DIN VDE 0682-415) and detects zero crossings, but no voltage values.

DEHNcap/PC-LRM



Type PV DCA PC ...	LRM
Part No.	767 132
Dimensions	145 x 85 x 32 mm
Measuring cables	3 measuring cables with multilam plug (Ø4 mm)
Length (measuring cable)	2000 mm
Indication threshold (LRM system)	5 V
Input impedance (LRM system)	2 MOhms

DEHNproX - 3. Verify that the installation is dead - DEHNcap voltage detecting system

DEHNcap/PC-LRM Phase Comparator Kit

Phase comparator in an artificial leather bag (KLT 23 164).



Type PV DCA PC ...	LRM T
Part No.	767 139
Dimensions	145 x 85 x 32 mm
Measuring cables	3 measuring cables with multilam plug (Ø4 mm)
Length (measuring cable)	2000 mm
Indication threshold (LRM system)	5 V
Input impedance (LRM system)	2 MOhms

Accessories for DEHNcap/PC-LRM Phase Comparator

Artificial leather bag, empty

With carrying strap.



Type	KLT 23 16 4
Part No.	767 500
Suitable for	DCA PC
Dimensions	235 x 160 x 40 mm
Colour	Black ●

DEHNcap Test Adapter



The HR-LRM test adapter for plugging an LRM indicator into a HR test socket.

Easy and safe testing

- Easy mechanical and electrical adaptation to HR, LR test sockets
- Measuring impedance for maintenance tests on coupling systems with suitable μA meter
- 4 mm safety plugs or sockets
- Energised HR plug, insulated

General technical data:

Standard	EN/IEC 61243-5 (DIN VDE 0682-415)
Temperature range	-25 °C ... +55 °C

HR-LRM Test Adapter

For electrical and mechanical adaptation of HR (HO) to LRM systems.



Used as a measuring impedance with $X_C = 36 \text{ MOhms}$ for maintenance tests on HR coupling systems (with suitable μA meter).

Type MA DCA ...	HR LRM
Part No.	767 133
Dimensions	90 x 50 x 30 mm
Plug spacing	19 mm
Socket spacing	14 mm
Type of plug	2 multilam plugs (Ø4 mm)
Type of test socket	2 sockets (Ø4 mm)

LR-LRM Test Adapter

For mechanical adaptation of LR (NO) to LRM systems.



Type MA DCA ...	LR LRM
Part No.	767 136
Dimensions	100 x 50 x 30 mm
Plug spacing	jack, 6.3 mm
Socket spacing	14 mm
Type of plug	1 jack
Type of test socket	2 sockets (Ø4 mm)

Electrodes

- Safe contact with the part of an installation to be tested
- With M8 thread, to be screwed on the test prods of PHE4, PHE III, PHE voltage detectors as well as PHV I phase comparators

Onion-shaped Electrode

For contacting varnished busbars.



Type EL M8 ...	SZ PHE PHV
Part No.	766 913
Nominal voltage (U _N)	From 3 kV
Material	Brass/gal CuSn

Pin-shaped Electrode

For contacting varnished busbars.



Type EL M8 ...	S PHE PHV
Part No.	766 925
Nominal voltage (U _N)	From 3 kV
Material	StSt

V-shaped Electrode

For contacting round conductors.



Type EL M8 ...	V PHE PHV
Part No.	766 927
Nominal voltage (U _N)	From 3 kV
Material	Cu/gal Sn

Hook-shaped Electrode

For contacting overhead line conductors.



Type EL M8 ...	H PHE
Part No.	766 923
Application	For overhead lines only
Material	St/gal Zn

Fork-shaped Electrode

For contacting overhead line conductors.



Type EL M8 ...	G PHE
Part No.	766 924
Application	For overhead lines only
Material	StSt

Eaton Holec Magnefix Electrode

For Eaton Holec Magnefix switchgear installations of type MA, MD4, MF, MG, MY.



Type EL M8 ...	MAG PHE PHV
Part No.	766 915
Nominal voltage (U _N)	3 ... 15 kV
Material	Brass/gal CuSn, PVC

Test Probes

- Safe contact with the part of an installation to be tested
- With M8 thread, to be screwed on test electrodes of PHE4, PHE III and PHE voltage detectors
- For switchgear installations with limited access
- Available in different lengths and angles

Test Probe, straight

For switchgear installations with limited access (e.g. Calor Emag/ Isopond and Krone/KES)

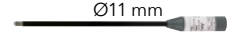

Type PSO M8 ...	PHE
Part No.	766 916
Nominal voltage (U _N)	3 ... 24 kV
Total length (l _G)	420 mm
Length (l _I)	300 mm
For use at	
Suitable for	PHE4, PHE III, PHE

Test Probe, straight, 800 mm

For transformer stations and switchgear installations that require a greater insertion depth.



Type PSO M8 ...	PHE L800
Part No.	766 960
Nominal voltage (U _N)	3 ... 24 kV
Total length (l _G)	890 mm
For use at	
Suitable for	PHE4, PHE III, PHE

Test Probe, 25° angled

For switchgear installations with limited access.

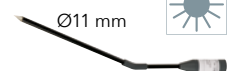

Type PSO M8 ...	W25 PHE
Part No.	766 940
Nominal voltage (U _N)	3 ... 24 kV
Total length (l _G)	450 mm
Length (l _I)	280 mm
For use at	
Suitable for	PHE4, PHE III, PHE

Test Probe, 45° angled

For switchgear installations with limited access.



Type PSO M8 ...	W45 PHE
Part No.	766 941
Nominal voltage (U _N)	3 ... 24 kV
Total length (l _G)	395 mm
Length (l _I)	280 mm
For use at	
Suitable for	PHE4, PHE III, PHE

Test Probe, 90° angled

For switchgear installations with a limited tulip-shaped access from bottom to top.



Type PSO M8 ...	W90 PHE
Part No.	766 950
Nominal voltage (U _N)	3 ... 36 kV
Total length (l _G)	200 mm
Length (l _I)	370 mm
For use at	
Suitable for	PHE4, PHE III, PHE

Adapters and End Fittings

Adapter (Plug-In Coupling / T Pin Shaft)

For extending the handle of IS ... STK insulating sticks by an ES SQ or ES SQL earthing stick.



Type	AD HV STK SQ
Part No.	766 313
Total length (l _G)	275 mm

End Fitting STK (Plug-in Coupling)

For use as termination and protection



Type	A STK
Part No.	766 888
Total length (l _G)	85 mm
Diameter	30 / 43 mm

End Fitting STK with Eye

For use as protection and transport eye when working on overhead lines.



Type	AR STK
Part No.	766 889
Total length (l _G)	150 mm
Diameter	30 / 43 mm

Storage Bags and Transport Cases / Easy Choice

See Page 56

Note: All storage bags and transport cases are delivered without content.

Storage Bags and Transport Cases	Sheet Steel Case		Plastic Case					Artificial Leather Bag					Storage Bag				
	767 701	767 997	767 999	766 036	766 998	766 995	766 994	767 107	767 996	766 602	766 996	767 574		767 500	766 614	766 543	766 601
Safety Equipment																	
PHE4 up to l _G 1450 mm																	
PHE4 up to l _G 3010 mm / * up to l _G 1760 mm																*	
PHE4 from l _G 4420 mm (l _G 5750 mm)																	
PHE III up to l _G 1675 mm																	
PHE III ZK Indicator with Test Prod																	
PHE III Kit * up to 1270 mm					*												
ASP * from Part No. 767 573								*									
HSA																	
PHE/G																	
Voltage detectors for LV Installations																	
PHV I up to l _G 1270 mm																	
PHV I up to l _G 1730 mm																	
DEHNcap																	

Storage Devices

- Wall-mounted
- Easy and safe storage of earthing and short-circuiting devices, voltage detectors and operating sticks (Ø30 or 43 mm)

For a Voltage Detector and an Earthing Stick

For a voltage detector and an earthing stick of any length
Hole spacing: 290/390 mm, holes: Ø7 mm



Type HV ...	P ST D24	P ST D30
Part No.	700 006	700 007
Dimensions	530 x 30 x 136 mm	430 x 30 x 136 mm
For stick diameters	24 mm	30 mm
DB material No.	-	828 077

Type HV ...	P ST D40 45
Part No.	700 008
Dimensions	530 x 30 x 149 mm
For stick diameters	40 ... 45 mm
DB material No.	-

For an Earthing and Short-Circuiting Device and an Earthing Stick

For an earthing and short-circuiting device and an earthing stick of any length
Hole spacing: 424 mm, holes: Ø7 mm



Type HV ...	EKV ES30	EKV ES40
Part No.	700 000	700 002
Dimensions	525 x 175 x 214 mm	525 x 175 x 214 mm
For stick diameters	30 mm	43 mm
DB drawing No.	3 Ebgw 01.70	-
DB material No.	742 395	-

For an Earthing and Short-Circuiting Device and an Earthing Stick up to 1.5 m

For an earthing and short-circuiting device and an earthing stick with a length up to 1.5 m
Hole spacing: 104 mm, holes: Ø7 mm



Type HV ...	EKV ES30 1500
Part No.	700 003
Dimensions	214 x 150 mm
For stick diameters	30 / 43 mm

Sheet Steel Case

Sheet Steel Case for PHE III
Hammer-tone finished with foam padding.



Type	SKL 95 21 10
Part No.	767 701
Dimensions	950 x 210 x 115 mm
Colour	Blue ●

Artificial Leather Bag

Artificial Leather Bag for PHE4, PHE III, ASP, PHV I and IS STK

With zip, carrier handle and shoulder strap.



Type KLT ...	101 30 10	133 34 10
Part No.	767 996	766 996
Dimensions	1010 x 300 x 100 mm	1300 x 345 x 100 mm
Colour	Black ●	Black ●

Plastic Case

Universal Plastic Case for PHE4, PHE III and PHV I

With aluminium frame and convoluted foam.



Type KKL ...	92 28 12	127 28 12
Part No.	766 994	766 995
Dimensions	920 x 280 x 126 mm	1270 x 280 x 126 mm
Colour	Black ●	Black ●

Artificial Leather Bag for PHE4 and PHE

With carrier handle



Type KLT ...	247 10 22
Part No.	766 602
Dimensions	2470 x 220 x 100 mm
Colour	Black ●

Artificial Leather Bag for PHE4, PHE and PHV I

With carrier handle



Plastic Case for PHE III

With foam padding



Type KKL ...	PHE3	PHE3 L
Part No.	767 997	767 999
Dimensions	940 x 235 x 140 mm	1290 x 235 x 140 mm
Colour	Black ●	Black ●

Artificial Leather Bag for ASP and HSA

With zip and carrier handle.



Type KLT ...	121 25 16
Part No.	766 601
Dimensions	1200 x 250 x 160 mm
Colour	Black ●

Plastic Case for PHE III Indicator with Test Prod

With foam padding



Type KKL ...	PK PHE3 L
Part No.	766 036
Dimensions	390 x 280 x 80 mm
Colour	Grey ●

Artificial Leather Bag for PHE/G

With carrier handle



Type KLT ...	104 9
Part No.	767 574
Dimensions	Ø90 x 1040 mm
Colour	Black ●

Plastic Case for PHE III - Kit

With foam padding



Type KKL ...	PHE3 60 110
Part No.	766 998
Dimensions	1290 x 235 x 140 mm
Colour	Black ●

Artificial Leather Bag for PHE/G

With carrier handle



Type KLT ...	160 17
Part No.	766 614
Dimensions	Ø170 x 1600 mm
Colour	Black ●

Plastic Case for DEHNcap

With foam padding



Type KKL ...	DCA
Part No.	767 107
Dimensions	390 x 280 x 84 mm
Colour	Grey ●

Canvas Bag

Canvas Bag for PHE and PHE/G I

With carrier handle.



Type STT ...	120 30 15
Part No.	766 704
Dimensions	1220 x 390 x 150 mm
Colour	Olive ●

Discharge and Equipotential Bonding Devices



Single-pole device for discharging static charges.

- For discharging static charges
- Different contact electrodes
- Coupling electrode, especially for round conductors (Ø12 ... 26.5 mm) of electrostatic precipitator systems
- Waterproof, plastic-sheathed cable entries, with additional anti-kink protection



General technical data:

Not for use in wet weather conditions	☀
Material (contact electrode)	Cu alloy/gal Sn
Material (contact and coupling electrode)	Zamak
Material (coupling electrode)	Bronze/gal Sn
Material (insulating tube)	Glass-fibre reinforced polyester tube
Material (earthing cable)	Cu, highly flexible

Discharge Device with Handle and Earth Clamp with Wing Bolt



Type	EV TES 465 EK
Part No.	758 020
Cable length	3500 mm
Cable cross-section	16 mm ²
Cable sheath	Transparent
Total length (l _G)	550 mm
Clamping range	Up to 20 mm

Discharge Device with Handle and Spring-loaded Earth Pliers

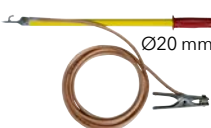

Type	EV TES 465 EZ
Part No.	758 021
Cable length	3500 mm
Cable cross-section	16 mm ²
Cable sheath	Transparent
Total length (l _G)	550 mm
Clamping range Rd / Fl	up to Ø16 mm / to 13 mm

Discharge Device with Handle and Cable Lug at the Earth Cable End

Hole (Ø8.4 mm) and silicone cable

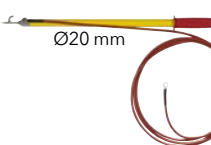

Type	EV TES 465 KS10
Part No.	758 022
Cable length	3500 mm
Cable cross-section	10 mm ²
Cable sheath	Red silicone cable
Total length (l _G)	550 mm

Discharge Device with Earth Clamp with Wing Bolt



Type	EV TS 2000 EK
Part No.	758 001
Cable length	3500 mm
Cable cross-section	16 mm ²
Cable sheath	Transparent
Total length (l _G)	2050 mm
Clamping range	Up to 20 mm

Discharge Device with Spring-loaded Earth Pliers



Type	EV TS 2000 EZ
Part No.	758 003
Cable length	3500 mm
Cable cross-section	16 mm ²
Cable sheath	Transparent
Total length (l _G)	2050 mm
Clamping range Rd / Fl	up to Ø16 mm / to 13 mm

Earthing Device with Earth Clamp with Tommy Bar

For round conductors (Ø12 ... 26.5 mm) of electrostatic precipitator systems



Type	EV EH 1725 EK
Part No.	758 015
Cable length	3500 mm
Cable cross-section	25 mm ²
Cable sheath	Transparent
Total length (l _G)	1725 mm
Clamping range	Up to 30 mm

Discharge Device with Contact and Coupling Electrode and Cable Lug at the Earth Cable End

PK1 anti-rotation crimped cable lug (hole Ø12.5 mm).

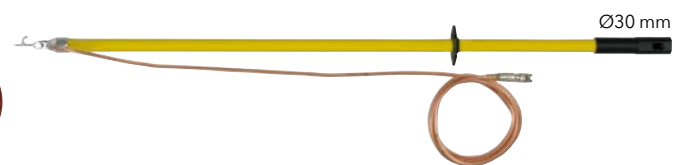

Type	EV TES STK 1500 KS
Part No.	758 025
Cable length	3500 mm
Cable cross-section	16 mm ²
Cable sheath	Transparent
Total length (l _G)	1500 mm

DEHNproX - 3. Verify that the installation is dead - Discharge Devices

Discharge Device with Clamp and Cable Lug at the Earth Cable End

PK1 anti-rotation crimped cable lug (hole Ø12.5 mm).



Type	EV EHB 1600 SN7114
Part No.	758 028
Cable length	3500 mm
Cable cross-section	16 mm ²
Cable sheath	Transparent
Total length (l _G)	1600 mm

Equipotential Bonding Device with Insulated Earth Clamps

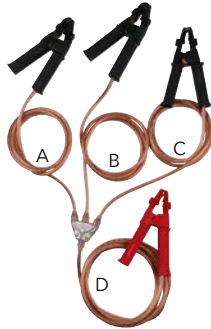

Type	PAV 3+1 16 ZAK
Part No.	758 099
Cable length (A / B / C)	1750 mm
Cable length (D)	3200 mm
Cable cross-section	16 mm ²
Cable sheath	transparent
Clamping range	5-25 mm

Discharge Device with Handle, without Earth Cable



Type	EV TES 465 SN7215
Part No.	758 036
Total length (l _G)	550 mm
Screw	M8 x 20 mm

Discharge Device with Contact Electrode without Earth Cable



Type	EV TS STK 1470
Part No.	758 075
Total length (l _G)	1470 mm
Screw	M8 x 20 mm

Discharge Device with Contact and Coupling Electrode without Earth Cable



Type	EV TES STK 1500
Part No.	758 085
Total length (l _G)	1500 mm
Screw	M8 x 20 mm

Discharge Device with Hook without Earth Cable



Type	EV EHB STK 1600
Part No.	758 095
Total length (l _G)	1600 mm
Screw	M8 x 20 mm

Accessories for Discharge and Equipotential Bonding Devices

Earth cable with crimped cable lug



Earthing cable combinable with discharge device.

PK1 crimped cable lug for connection with earth connecting elements.

General technical data:

Material	Cu
Type of crimped cable lug	PK1 (Ø12.5 mm) and PK2 (Ø8.5 mm)
Cable length	To be specified on order (500-25000 mm)

Type	EL 16CU KS12.5 8.5	EL 25CU KS12.5 8.5
Part No.	758 116	758 125
Cable cross-section	16 mm ²	25 mm ²

Type	EL 35CU KS12.5 8.5
Part No.	758 135
Cable cross-section	35 mm ²

Earthing cable length to be specified when ordering (in steps of 500 mm).





Earth cable with earth pliers



Earth cable combinable with discharge device.

Type	EL 16CU EZ KS8.5
Part No.	758 216
Material (cable)	Cu
Type of crimped cable lug	PK2 (Ø8.5 mm)
Material of pliers	StSt
Clamping range Rd / Fl	Up to Ø16 mm / up to 13 mm
Cable cross-section	16 mm ²
Cable length	To be specified on order (500-25000 mm)

Earthing cable length to be specified when ordering (in steps of 500 mm).

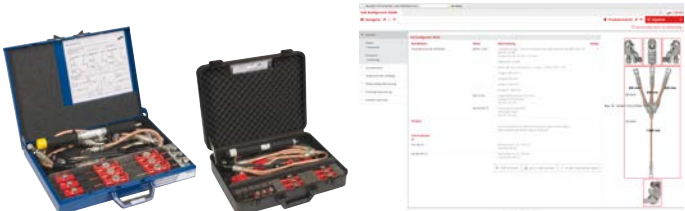
Type / Application	Product	Page
Fixed phase and earthing points		63
EaS cables, unequipped ▪ Single to five-pole		67
Phase connection elements ▪ For switchgear installations ▪ For overhead lines		70
Earth-side connection elements ▪ Earthing kit/spike ▪ For switchgear installations and overhead lines		74
Earthing sticks ▪ For switchgear installations, single and two-part ▪ For overhead lines, telescopic and multi-part		77
EaS devices, short-circuiting bars		79

Maintenance test according to German Social Accident Insurance (DGUV) Regulation 3 (formerly accident prevention regulations (BGV A3))

According to DGUV regulation 3 (formerly BGV A3), §5 paragraph 1, operating equipment, which also includes EaS devices, must be checked to ensure it is in good condition and at specific intervals. The intervals shall be selected in such a way that defects which are to be anticipated are detected in good time. This test is carried out at DEHN or on the customer's premises according to a new measuring method^{*)} and includes

- Visual inspection to detect visible defects.
- Measurement of the total resistance at the stationary EaS device (static test)
- Measurement of the relative change in resistance in the cable and at the connection points of the moving EaS device (dynamic test).

The maintenance test is documented in a test report and on the device itself.

^{*)} This measuring procedure was developed on behalf of BG ETEM (German trade association for energy, textiles, electrical goods and media products) at the University of Applied Sciences Dresden (HTW Dresden).



Earthing and Short-Circuiting Devices

The key point of the five safety rules for dead working is earthing and short-circuiting at the work location. This measure ensures the de-energised state for the duration of the work, also with regard to interference voltages, atmospheric surges or erroneous reconnection.

Portable devices for earthing and short-circuiting may only be used if the absence of voltage has been verified immediately beforehand at the place of installation.

When connecting the earthing and short-circuiting device, the earthing cable must always be connected to the earthing system first, so that any residual or interference voltages present are discharged.

Portable devices for earthing or earthing and short-circuiting according to DIN VDE 0683-100 (EN/IEC 61230) are devices to be used manually which are brought up to and connected with the fixed connection points of parts of electrical installations for the purpose of earthing and short-circuiting (according to DIN VDE 0105-100 or EN 50110-1, section 6.2.4) without forced guidance (e.g. slots, sockets, guide rails). They consist of earthing and short-circuiting devices (EaS devices) and earthing sticks.

The **earthing and short-circuiting device** is a device with which electrical conductors can be both earthed and short-circuited. It consists of an earthing device and a short-circuiting device. The earthing device is a device for connecting the earth-termination system to a short-circuiting device or to the equipment to be earthed. It consists of a connection component (1) and earthing cable (4).

The short-circuiting device is a device for connecting the line conductors to be short-circuited. It consists of connection components (1+2), short-circuiting cables or bars (3) and, where necessary, connecting clusters (5).

The **short-circuiting bar** is a rigid short-circuiting device.

Connecting clusters connect the short-circuiting cables to each other and to the earthing cable or the short-circuiting bar to the earthing cable.

Connection components connect the earthing and short-circuiting cables or busbars directly or via intermediate links, e.g. via cable lugs, to the earthing system and the system parts, where necessary via fixed connection points. Fixed connection points are those points on system parts to which the earthing and short-circuiting devices are connected, e.g. cables, bars, fixed ball points, cylinder bolts, stirrups. The connection of the fixed ball point and the ball head cap of the earthing and short-circuiting device ensures the highest degree of short-circuit strength.

Fixed connection points are parts of the installation to which earthing and short-circuiting devices are connected (e.g. conductors, bars, fixed ball points, cylinder bolts, clamps etc.). Maximum short-circuit strength can be achieved by connecting the fixed ball point with the ball head cap of the earthing and short-circuiting device.

Earthing sticks are hand-held insulating sticks for bringing the connection components of earthing and short-circuiting devices up to parts of power installations for the purpose of earthing and short-circuiting. They consist of an insulating element, black ring, handle and coupling for holding a connection component. Earthing sticks must be selected according to the weight of the earthing and short-circuiting device to be installed (see specification: "maximum permissible load on the operating head in kg").

The **insulating element** is the part of the earthing stick between the black ring and the end of the earthing stick in the direction of the connection component. It ensures that the user maintains the required safety distance, and it provides sufficient insulation. In installations exceeding 1 kV, the insulating element must have a minimum length l_i of 500 mm.

A complete device for earthing and short-circuiting according to DIN VDE 0683-100 (EN/IEC 61230) consists of, e.g.:

- Fixed point/fixed ball point
- One or three-pole earthing and short-circuiting device or short-circuiting bar
- Fixed earthing terminal
- Earthing stick

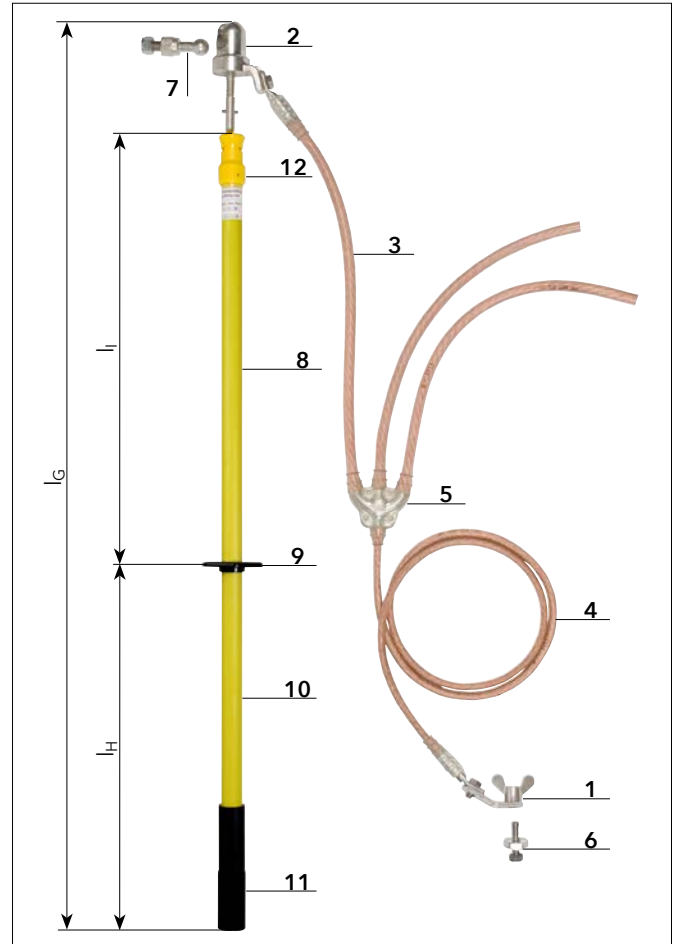

- | | |
|--|--|
| 1 Connection component to earth-termination system | 7 Line connection point |
| 2 Connection component to line | 8 Insulating element with length l_i |
| 3 Short-circuiting cable | 9 Hand guard |
| 4 Earthing cable | 10 Handle with length l_H |
| 5 Connecting cluster | 11 End fitting with plug-in coupling |
| 6 Earth connection point | 12 Coupling |

Portable devices for earthing or earthing and short-circuiting

Earthed and short-circuiting devices as well as fixed ball and earthing points must be rated for the **short-circuit current** possible at the point of use. The required cable cross-sections depend on the max. short-circuit current I_k in A and the short-circuit duration T_k in s.

Note:

In the event of a short-circuit, the short-circuit current flows via short-circuiting devices, which is what the devices are rated for – but this is not the case with earthing devices. These do not carry short-circuit current and can therefore have a weaker design.

Cable cross-section:

In the case of three-pole earthing and short-circuiting devices, the cross-section of the earthing cable can always be reduced according to the following table for short-circuiting cables of 50 mm² and larger.

These earthing and short-circuiting devices with reduced earthing cable cross-section can be used in all networks without direct neutral earthing (e.g. compensated system with impedance neutral earthing).

For networks with direct (rigid) neutral earthing, the short-circuiting and earthing cables must have the same cross-section.

The required cable or bar cross-sections of the short-circuiting device can be determined from the diagrams or the table according to the short-circuit current and the short-circuit duration for an installation.

Cable Cross-Section	
Short-circuiting cable	Earthing cable
16 mm ²	16 mm ²
25 mm ²	25 mm ²
35 mm ²	35 mm ²
50 mm ²	25 mm ²
70 mm ²	35 mm ²
95 mm ²	35 mm ²
120 mm ²	50 mm ²
150 mm ²	50 mm ²

The current carrying capacity of the short-circuiting cable and the short-circuiting bar depends on the material, cross-section (A) and short-circuit duration (T_k).

The calculations were based on the worst case of the off-generator short-circuit (μ = 1) and the highest DC component (χ = 1.8) with I_k'' as the maximum initial short-circuit alternating current, which according to DIN VDE 0102 is equal to the sustained short-circuit current I_k and equal to the breaking current I_a:

$$I_k'' = I_k = I_a$$

Current carrying capacity of copper short-circuiting cables for use in three-phase systems

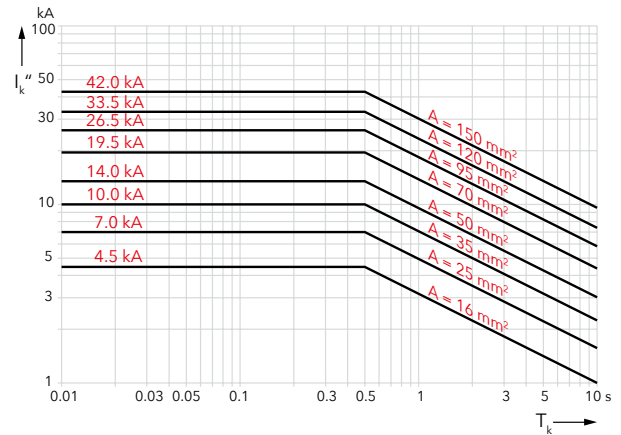

Initial cable temperature 20 °C
 Final cable temperature 250 °C
 $A = 5.07 I_k'' \sqrt{T_k}$ for $T_k \geq 0.5$ s
 Meaning here:
 A Cable cross-section in mm²
 I_k'' maximum initial symmetrical short-circuit current in kA as per DIN VDE 0102
 T_k short-circuit duration in s

Current carrying capability of copper short-circuiting cables for use in DC installations

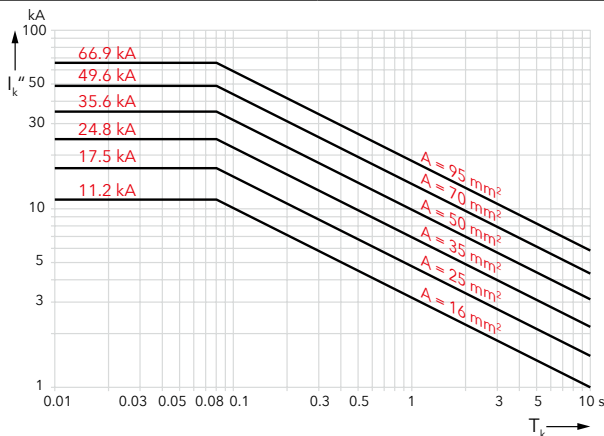

Initial cable temperature 20 °C
 Final cable temperature 250 °C
 $A = 5.07 I_k'' \sqrt{T_k}$ for $T_k \geq 0.08$ s
 Meaning here:
 A Cable cross-section in mm²
 I_k'' maximum initial symmetrical short-circuit current in kA as per DIN VDE 0102
 T_k short-circuit duration in s

Current carrying capability of copper short-circuiting cables for use on the overhead contact lines of electric railways

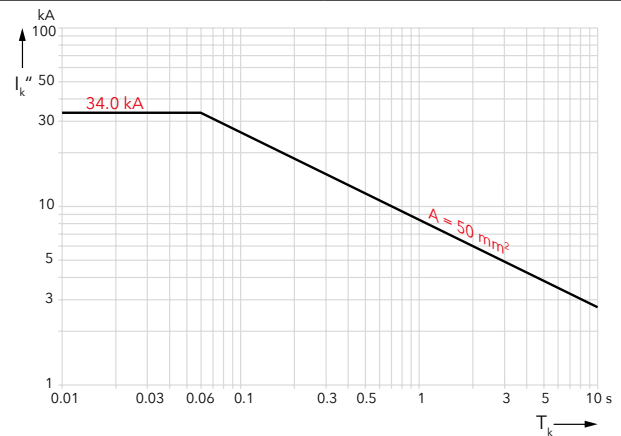

Initial cable temperature 20 °C
 Final cable temperature 250 °C
 $A = 6.0 I_k'' \sqrt{T_k}$ for $T_k \geq 0.06$ s
 Meaning here:
 A Cable cross-section in mm²
 I_k'' maximum initial symmetrical short-circuit current in kA as per DIN VDE 0102
 T_k short-circuit duration in s

Calculation example:

Specified: mains breaking capacity S_a
short-circuit duration T_k

Sought: required cable or bar cross-section A.

The off-generator short-circuit is used as a basis.

$$\text{Three-phase current} \quad I_k'' = I_k = I_a = \frac{S_a}{\sqrt{3} \cdot U_N}$$

$$\text{Single-phase alternating current} \quad I_k'' = I_k = I_a = \frac{S_a}{U_N}$$

With " I_k " the required cable or bar cross-section can now be calculated from the above equations or taken from the diagrams. The permissible current-time load capacity of an earthing and short-circuiting device is indicated by the cross-section specification on the short-circuiting cables or bars.

Note:

- Earthing and short-circuiting devices are only rated for a one-off exposure to the permissible current-time load!
- Short-circuiting cables of multipole earthing and short-circuiting devices must have the same cross-sections.
- The cable lengths of the earthing and short-circuiting devices should be at least 1.2 times the distance between two fixed connection points. Furthermore, the cable lengths selected should be as short as possible, as the cables will move violently in the event of a short-circuit.
- If earthing and short-circuiting devices are connected in parallel with cables to reach certain total cable cross-sections, the following conditions are to be observed:
 1. same cable lengths and cross-sections,
 2. same connection components and points,
 3. installation of the devices close together with parallel arrangement of the cables,
 4. for each cable, the permissible load capacity must be reduced to 75% of that of the corresponding the cable cross-section.

Note:

If it is ensured that earthing and short-circuiting devices connected in parallel are only loaded once with the full short-circuit current (no automatic reclosing or short interruption), the devices may be fully loaded.

Table:

Cable cross-section of the earthing and short-circuiting device depending on the maximum short-circuit current I_k and the maximum short-circuit duration T_k

▪ for copper (Cu)

Cross-section of the copper cable	Maximum permissible short-circuit current I_k for a duration of				
	10 s	5 s	2 s	1 s ^{*)}	≤ 0.5 s ^{*)}
16 mm ²	1 000 A	1 400 A	2 200 A	3 200 A	4 500 A
25 mm ²	1 600 A	2 200 A	3 500 A	4 900 A	7 000 A
35 mm ²	2 200 A	3 100 A	4 900 A	6 900 A	10 000 A
50 mm ²	3 100 A	4 400 A	7 000 A	9 900 A	14 000 A
70 mm ²	4 400 A	6 200 A	9 800 A	13 800 A	19 500 A
95 mm ²	5 900 A	8 400 A	13 200 A	18 700 A	26 500 A
120 mm ²	7 500 A	10 600 A	16 700 A	23 700 A	33 500 A
150 mm ²	9 400 A	13 200 A	20 900 A	29 600 A	42 000 A

^{*)} catalogue data

▪ for aluminium (Al)

Cross-section of the aluminium cable	Maximum permissible short-circuit current I_k for a duration of				
	10 s	5 s	2 s	1 s ^{*)}	≤ 0.5 s ^{*)}
35 mm ²	1 400 A	2 000 A	3 200 A	4 600 A	6 500 A
50 mm ²	2 100 A	2 900 A	4 600 A	6 600 A	9 300 A

^{*)} catalogue data

Fixed Ball Points



Straight fixed ball point mounted on a busbar.

Ø20 or 25 mm

- Suitable for fixing busbar connections according to DIN 43673-1
- Self-locking nut
- M12 or M16 non-cutting formed female thread
- M12 or M16 threaded pin

General technical data:

Standard	EN/IEC 61230 (DIN VDE 0683-100) and based on DIN 48088-1
Material (fixed ball point)	E-Cu/gal Sn
Material (threaded pin)	StSt A2-70
Hexagon nut	DIN 985-M12-8 / gal Zn; DIN 985-M16-8 / gal Zn
Tightening torque	M10: 30-40 Nm; M12: 50-65 Nm; M16: 100-110 Nm

Angled with Terminal Lug



Type KFP ...	20 S AL 12	25 S AL 12
Part No.	706 300	756 300
Fixed ball point Ø	20 mm	25 mm
Bore Ø	12.5 mm	12.5 mm
Dimensions	45 x 30 x 9 mm	50 x 30 x 9 mm
Max. cable cross-section Cu	50 mm ²	95 mm ²
Max. short-circuit current I _k 0.5 s	14.0 kA	26.5 kA
Max. short-circuit current I _k 1 s	9.9 kA	18.7 kA

Straight with Round Conductor Half Shell for Round Copper Conductors



General technical data:

Fixed ball point Ø	25 mm
Max. cable cross-section Cu	95 mm ²
Max. short-circuit current I _k 0.5 s	26.5 kA
Max. short-circuit current I _k 1 s	18.7 kA

Type KFP ...	25 RL 10	25 RL 12
Part No.	725 010	725 012
For round conductor Ød	10 mm	12 mm

Type KFP ...	25 RL 14	25 RL 16
Part No.	725 014	725 016
For round conductor Ød	14 mm	16 mm

Type KFP ...	25 RL 18	25 RL 20
Part No.	725 018	725 020
For round conductor Ød	18 mm	20 mm

Straight with Threaded Pin and Self-locking Nut



Type KFP ...	20 M12 35 SSM	20 M12 45 SN7078
Part No.	754 235	754 238
Fixed ball point Ø	20 mm	20 mm
Dimensions	M12 x 35 mm	M12 x 45 mm
Wrench size	24 mm	24 mm
Max. cable cross-section Cu	120 mm ²	120 mm ²
Max. short-circuit current I _k 0.5 s	33.5 kA	33.5 kA
Max. short-circuit current I _k 1 s	23.7 kA	23.7 kA

Type KFP ...	20 M16 45 SSM	25 M12 25 SSM
Part No.	754 645	755 225
Fixed ball point Ø	20 mm	25 mm
Dimensions	M16 x 45 mm	M12 x 25 mm
Wrench size	24 mm	27 mm
Max. cable cross-section Cu	120 mm ²	150 mm ²
Max. short-circuit current I _k 0.5 s	33.5 kA	42.0 kA
Max. short-circuit current I _k 1 s	23.7 kA	29.6 kA

Type KFP ...	25 M12 45 SSM	25 M16 45 SSM
Part No.	755 245	755 645
Fixed ball point Ø	25 mm	25 mm
Dimensions	M12 x 45 mm	M16 x 45 mm
Wrench size	27 mm	27 mm
Max. cable cross-section Cu	150 mm ²	150 mm ²
Max. short-circuit current I _k 0.5 s	42.0 kA	42.0 kA
Max. short-circuit current I _k 1 s	29.6 kA	29.6 kA

Straight with Female Thread



Type KFP ...	20 M10	20 M12
Part No.	754 205	754 200
Fixed ball point Ø	20 mm	20 mm
Dimensions	M10	M12
Wrench size	24 mm	24 mm
Max. cable cross-section Cu	120 mm ²	120 mm ²
Max. short-circuit current I _k 0.5 s	33.5 kA	33.5 kA
Max. short-circuit current I _k 1 s	23.7 kA	23.7 kA

Type KFP ...	20 M16	25 M12
Part No.	754 600	755 200
Fixed ball point Ø	20 mm	25 mm
Dimensions	M16	M12
Wrench size	24 mm	27 mm
Max. cable cross-section Cu	120 mm ²	150 mm ²
Max. short-circuit current I _k 0.5 s	33.5 kA	42.0 kA
Max. short-circuit current I _k 1 s	23.7 kA	29.6 kA

Type KFP ...	25 M16
Part No.	755 600
Fixed ball point Ø	25 mm
Dimensions	M16
Wrench size	27 mm
Max. cable cross-section Cu	150 mm ²
Max. short-circuit current I _k 0.5 s	42.0 kA
Max. short-circuit current I _k 1 s	29.6 kA

45° angled with Threaded Pin and Self-locking Nut



Type KFP ...	20 W45M12 SN7024	20 W45 M12 35SSM
Part No.	706 239	706 235
Fixed ball point Ø	20 mm	20 mm
Dimensions	M12 x 30 mm	M12 x 35 mm
Wrench size	24 mm	24 mm
Max. cable cross-section Cu	70 mm ²	70 mm ²
Max. short-circuit current I _k 0.5 s	19.5 kA	19.5 kA
Max. short-circuit current I _k 1 s	13.8 kA	13.8 kA

Type KFP ...	20 W45 M16 45SSM	25 W45 M12 45SSM
Part No.	706 645	756 245
Fixed ball point Ø	20 mm	25 mm
Dimensions	M16 x 45 mm	M12 x 45 mm
Wrench size	24 mm	27 mm
Max. cable cross-section Cu	70 mm ²	95 mm ²
Max. short-circuit current I _k 0.5 s	19.5 kA	26.5 kA
Max. short-circuit current I _k 1 s	13.8 kA	18.7 kA

Type KFP ...	25 W45 M16 45SSM
Part No.	756 645
Fixed ball point Ø	25 mm
Dimensions	M16 x 45 mm
Wrench size	27 mm
Max. cable cross-section Cu	95 mm ²
Max. short-circuit current I _k 0.5 s	26.5 kA
Max. short-circuit current I _k 1 s	18.7 kA

45° angled with Female Thread



Type KFP ...	20 W45 M12	20 W45 M16
Part No.	706 200	706 600
Fixed ball point Ø	20 mm	20 mm
Dimensions	M12	M16
Wrench size	24 mm	24 mm
Max. cable cross-section Cu	70 mm ²	70 mm ²
Max. short-circuit current I _k 0.5 s	19.5 kA	19.5 kA
Max. short-circuit current I _k 1 s	13.8 kA	13.8 kA

Type KFP ...	25 W45 M12	25 W45 M16
Part No.	756 200	756 600
Fixed ball point Ø	25 mm	25 mm
Dimensions	M12	M16
Wrench size	27 mm	27 mm
Max. cable cross-section Cu	95 mm ²	95 mm ²
Max. short-circuit current I _k 0.5 s	26.5 kA	26.5 kA
Max. short-circuit current I _k 1 s	18.7 kA	18.7 kA

90° angled with Threaded Pin and Self-locking Nut



Type KFP ...	20 W90 M12 35SSM	20 W90 M16 45SSM
Part No.	707 235	707 645
Fixed ball point Ø	20 mm	20 mm
Dimensions	M12 x 35 mm	M16 x 45 mm
Wrench size	24 mm	24 mm
Max. cable cross-section Cu	70 mm ²	70 mm ²
Max. short-circuit current I _k 0.5 s	19.5 kA	19.5 kA
Max. short-circuit current I _k 1 s	13.8 kA	13.8 kA

Type KFP ...	25 W90 M12 45SSM	25 W90 M16 45SSM
Part No.	757 245	757 645
Fixed ball point Ø	25 mm	25 mm
Dimensions	M12 x 45 mm	M16 x 45 mm
Wrench size	27 mm	27 mm
Max. cable cross-section Cu	95 mm ²	95 mm ²
Max. short-circuit current I _k 0.5 s	26.5 kA	26.5 kA
Max. short-circuit current I _k 1 s	18.7 kA	18.7 kA

90° angled with Female Thread



Type KFP ...	20 W90 M12	20 W90 M16
Part No.	707 200	707 600
Fixed ball point Ø	20 mm	20 mm
Dimensions	M12	M16
Wrench size	24 mm	24 mm
Max. cable cross-section Cu	70 mm ²	70 mm ²
Max. short-circuit current I _k 0.5 s	19.5 kA	19.5 kA
Max. short-circuit current I _k 1 s	13.8 kA	13.8 kA

Type KFP ...	25 W90 M12	25 W90 M16
Part No.	757 200	757 600
Fixed ball point Ø	25 mm	25 mm
Dimensions	M12	M16
Wrench size	27 mm	27 mm
Max. cable cross-section Cu	95 mm ²	95 mm ²
Max. short-circuit current I _k 0.5 s	26.5 kA	26.5 kA
Max. short-circuit current I _k 1 s	18.7 kA	18.7 kA

Fixed Earthing Points



Fixed earthing point with ring groove and earth bushing.

Ring groove and connecting elements

- For connecting earth bushings or earth connecting plates in accordance with DIN 48088-2
- Welding-type or bolted-type connector for connecting earth connectors with wing nut or wing bolt on the earth cable end
- Connectors with M12 or M16 threaded pin
- M12 or M16 female thread

Ring Groove Fixed Point with Threaded Pin and Nut



Type	EFP 16 RN M12 35 SSM	EFP 16 RN M16 45 SSM
Part No.	790 251	790 261
Dimensions	M12 x 35 mm	M16 x 45 mm
Diameter	16 mm	16 mm
Wrench size	22 mm	22 mm
Max. cable cross-section Cu	150 mm ²	150 mm ²
Max. short-circuit current I _k 0.5 s	42.0*) kA	42.0*) kA
Max. short-circuit current I _k 1 s	29.6*) kA	29.6*) kA
Material	Brass (CuNi2Si) / gal Sn	Brass (CuNi2Si) / gal Sn
Material (threaded pin)	StSt A2-70	StSt A2-70
Material (nut)	DIN 985-M12-8 / gal Zn	DIN 985-M16-8 / gal Zn

*) For earthing and short-circuiting devices with cable lengths > 4000 mm: 26.5 kA / 0.5 s (18.7 kA / 1 s)

Ring Groove Fixed Point with Female Thread



Type	EFP 16 RN M12	EFP 16 RN M16
Part No.	790 250	790 260
Dimensions	M12	M16
Diameter	16 mm	16 mm
Wrench size	22 mm	22 mm
Max. cable cross-section Cu	150 mm ²	150 mm ²
Max. short-circuit current I _k 0.5 s	42.0*) kA	42.0*) kA
Max. short-circuit current I _k 1 s	29.6*) kA	29.6*) kA
Material	Brass (CuNi2Si) / gal Sn	Brass (CuNi2Si) / gal Sn

*) For earthing and short-circuiting devices with cable lengths > 4000 mm: 26.5 kA / 0.5 s (18.7 kA / 1 s)

General technical data:

Standard	EN/IEC 61230 (DIN VDE 0683-100) and DIN 48088-2 and -5
Tightening torque	M12: 50 ... 65 Nm; M16: 100 ... 110 Nm

Weld-on Connector with Threaded Pin



Type	AS SCHW M12 25	AS SCHW M16 30
Part No.	705 501	755 501
Dimensions	M12 x 25 mm	M16 x 30 mm
Material	St/gal Zn	St/gal Zn

Weld-on Connector with Female Thread



Type	AS SCHW M12	AS SCHW M16
Part No.	336 020	336 025
Dimensions	M12	M16
Material	St/gal Zn	St/gal Zn

Bolted-type Connector with Female Thread



Type	AS SCHR M12 M12 40
Part No.	705 504
Dimensions	M12 / M12 x 40 mm
Wrench size	27 mm
Material	Copper alloy/gal Sn

Bolted-type Connector with Threaded Pin and Separate Hexagon Nut



Type	AS SCHR M12 55	AS SCHR M16 65
Part No.	705 500	750 500
Dimensions	M12 x 55 mm	M16 x 65 mm
Wrench size	32 mm	41 mm
Material (threaded pin)	StSt	StSt
Material (nut)	Copper alloy/gal Sn / HDG steel	Copper alloy/gal Sn / HDG steel

Bolted-type Connector for Converting from M12 to M16 Threaded Pin



Type	AS SCHR M16 55 M12
Part No.	705 510
Dimensions	M12 x 20 mm / M16 x 55 mm
Wrench size	41 mm
Material (threaded pin)	StSt
Material (nut)	Copper alloy/gal Sn

Fastening Material

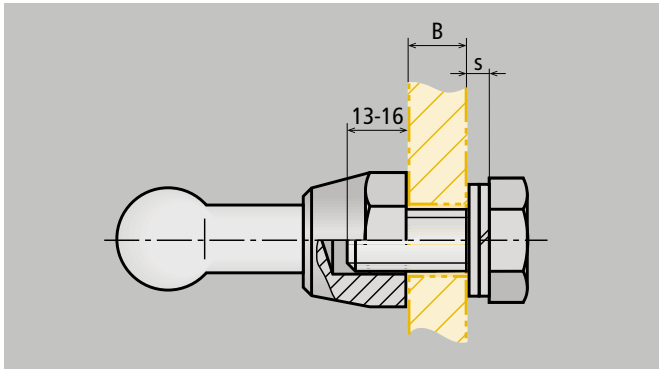

Determination of the required bolt length.

For fixed ball and earthing points

- Hexagon bolt for fixing busbar connections according to DIN 43673-1
- Resilient pressure plate for installing M12 or M16 fixed points on aluminium busbars

General technical data:

Standard (hexagon bolts)	In accordance with DIN 933 and DIN 43673-1
Standard (spring washers)	In accordance with DIN 128
Standard (washers)	In accordance with DIN 125

Determination of the bolt length l

$l \text{ (mm)} = B + s + 13 \dots 16$

- l = Bolt length
- B = Thickness of the busbar
- s = Thickness of the spring washer and washer

Hexagon Bolts



General technical data:

Material	StSt A2-70	
Type	SKS M10X30 V2A	SKS M12X25 V2A
Part No.	561 924	561 925
Dimensions	M10 x 30 mm	M12 x 25 mm
Type	SKS M12X30 V2A	SKS M12X35 V2A
Part No.	561 930	561 935
Dimensions	M12 x 30 mm	M12 x 35 mm
Type	SKS M16X30 V2A	
Part No.	561 931	
Dimensions	M16 x 30 mm	

Resilient Square Pressure Plate

For reliable contact and permanent installation of fixed ball points on aluminium busbars. Pressure plates must be shimmed on both sides of the busbar.



Type	DP 40 40 B13 AL	DP 50 50 B17 AL
Part No.	525 001	525 002
Dimensions	M12, 40 x 40 x 6 mm	M16, 50 x 50 x 8 mm
Material	Highly resistant Al alloy	Highly resistant Al alloy

Spring Washers



General technical data:

Material	StSt A2-70	
Type	FR A10 V2A	FR A12 V2A
Part No.	524 910	524 912
Dimensions	A10 (s = 2.2) mm	A12 (s = 2.4) mm
Type	FR A16 V2A	
Part No.	524 913	
Dimensions	A16 (s = 2.8) mm	

Washers



Type	SCH A10.5 V4A	SCH A13 V4A
Part No.	525 910	525 912
Dimensions	A10.5 (s = 2.0) mm	A13 (s = 2.4) mm
Material	StSt A4-70	StSt A4-70
Type	SCH A17 V2A	
Part No.	525 916	
Dimensions	A17 (s = 3.0) mm	
Material	StSt A2-70	

Earth Connecting Plates



Earth connecting plate with fixed ball points and ball head cap with plastic handle.

- Connecting plate with high short-circuit current carrying capacity
- Single-pole connection of the phase arms
- For connecting single-pole earthing and short-circuiting devices to transformers of overhead line masts or to fuse holders
- For fixed ball points (Ø20 mm, Ø25 mm) or ring groove pins (Ø16 mm)

General technical data:	
Standard	EN/IEC 61230 (DIN VDE 0683-100) and fixed points in accordance with DIN 48088-1
Material (plate)	Aluminium
Material (terminal lug)	4 mm: Cu / gal Sn; 6 mm: HDG steel
Material (fixed point)	E-Cu / brass (CuNi2Si) / gal Sn

With three Fixed Ball Points and Ball Head Cap



Type EAPA 3 ...	KFP 20 KKH	KFP 25 KKH
Part No.	728 620	728 625
Fixed point Ø	20 mm	25 mm
Max. cable cross-section Cu	120 mm ²	150 mm ²
Max. short-circuit current I _k 0.5 s	33.5 kA	42.0 kA
Max. short-circuit current I _k 1 s	23.7 kA	29.6 kA

With three Fixed Ball Points

For mounting on earth connecting clamps with PK1 anti-rotation protection.



Type EAPA 3 ...	KFP 20 B13	KFP 25 B13
Part No.	728 522	728 526
Fixed point Ø	20 mm	25 mm
Max. cable cross-section Cu	120 mm ²	150 mm ²
Max. short-circuit current I _k 0.5 s	33.5 kA	42.0 kA
Max. short-circuit current I _k 1 s	23.7 kA	29.6 kA

With three Ring Groove Fixed Points and Earth Bushing



Type EAPA 3 ...	RN 16 EAB
Part No.	728 516
Fixed point Ø	16 mm
Max. cable cross-section Cu	95 mm ²
Max. short-circuit current I _k 0.5 s	26.5 kA
Max. short-circuit current I _k 1 s	18.7 kA

Earthing and Short-Circuiting Cables, unequipped



Equipped three-pole earthing and short-circuiting device in a switchgear installation.

- To be equipped with connecting components
- Transparent sheath
- Waterproof and plastic-sheathed cable entries and node unit, additional anti-kink protection
- Standard anti-rotation crimped cable lugs (type PK1)
- Other cable lengths and crimped cable lugs can be selected online via the earthing and short-circuiting configurator
- Earthing and short-circuiting devices can be configured online via the earthing and short-circuiting configurator

General technical data:	
Standard	EN/IEC 61138 (DIN VDE 0283-3) and EN/IEC 61230 (DIN VDE 0683-100)
Temperature range	- 25 °C ... +55 °C
Material (cable)	Al, flexible; E-Cu, extra finely stranded and highly flexible
Material (sheath)	Thermoplastic polymer (flexible PVC compound YM2)
Hole (cable lug)	Ø12.5 mm



Crimped cable lugs, type PK1: Standard anti-rotation cable lug with cut-out.



Crimped cable lugs, type PK2: Cable lugs without cut-out for connecting parts from other manufacturers are available on request.



Crimped cable lugs, type PK3: Hook-type cable lugs up to cable cross-sections of 35 mm² are available on request.

Earthing Cable Cu in accordance with IEC 61138

The cable is delivered without crimped cable lugs and can be ordered by the metre.



General technical data:		
Minimum order quantity *)	1 m	
Type	ES YM2 16	ES YM2 25
Part No.	716 001	725 001
Cable cross-section	16 mm ²	25 mm ²
Type	ES YM2 35	ES YM2 50
Part No.	735 001	750 001
Cable cross-section	35 mm ²	50 mm ²
Type	ES YM2 70	ES YM2 95
Part No.	770 001	795 001
Cable cross-section	70 mm ²	95 mm ²
Type	ES YM2 120	ES YM2 150
Part No.	712 001	715 001
Cable cross-section	120 mm ²	150 mm ²

*) Length of earthing cable to be specified when ordering (in whole metres).

Single-pole Earthing and Short-circuiting Cables, aluminium version



Type EKV1+0 ...	35 VGHVBP5	50 VKVBG8W
Part No.	VGHVBP5	VKVBG8W
Cable cross-section	35 mm ²	50 mm ²
Material	Al	Al
Max. short-circuit current I _k 0.5 s	6.5 kA	9.3 kA
Max. short-circuit current I _k 1 s	4.6 kA	6.6 kA
Crimped cable lug	PK1	PK1

Attention: Please state the relevant Variant No. when ordering.

Single-pole Earthing and Short-circuiting Cables, copper version



General technical data:		
Material	Cu	
Crimped cable lug	PK1	
Type EKV1+0 ...	16 V4YPRGE	25 VSY71K4
Part No.	V4YPRGE	VSY71K4
Cable cross-section	16 mm ²	25 mm ²
Max. short-circuit current I _k 0.5 s	4.5 kA	7.0 kA
Max. short-circuit current I _k 1 s	3.2 kA	4.9 kA
Type EKV1+0 ...	35 V9JF26K	50 VRJG23Y
Part No.	V9JF26K	VRJG23Y
Cable cross-section	35 mm ²	50 mm ²
Max. short-circuit current I _k 0.5 s	10.0 kA	14.0 kA
Max. short-circuit current I _k 1 s	6.9 kA	9.9 kA

Type EKV1+0 ...	70 VPZBBSL	95 VZC3FST
Part No.	VPZBBSL	VZC3FST
Cable cross-section	70 mm ²	95 mm ²
Max. short-circuit current I _k 0.5 s	19.5 kA	26.5 kA
Max. short-circuit current I _k 1 s	13.8 kA	18.7 kA

Type EKV1+0 ...	120 V797FE6	150 VB53TC9
Part No.	V797FE6	VB53TC9
Cable cross-section	120 mm ²	150 mm ²
Max. short-circuit current I _k 0.5 s	33.5 kA	42.0 kA
Max. short-circuit current I _k 1 s	23.7 kA	29.6 kA

Attention: Please state the relevant Variant No. when ordering.

Two-pole Earthing and Short-circuiting Cables, copper version

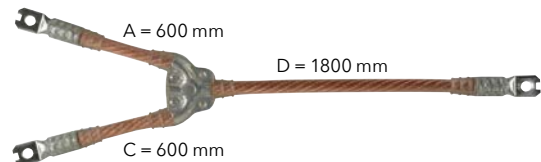

General technical data:	
Material	Cu
Crimped cable lug	PK1

Type EKV2+0 ...	16 G V7265NS	25 G VZL6TGH
Part No.	V7265NS	VZL6TGH
Cable cross-section	16 mm ²	25 mm ²
Max. short-circuit current I _k 0.5 s	4.5 kA	7.0 kA
Max. short-circuit current I _k 1 s	3.2 kA	4.9 kA

Type EKV2+0 ...	35 G VPHPZV2	50 G VJ13VWW
Part No.	VPHPZV2	VJ13VWW
Cable cross-section	35 mm ²	50 mm ²
Max. short-circuit current I _k 0.5 s	10.0 kA	14.0 kA
Max. short-circuit current I _k 1 s	6.9 kA	9.9 kA

Type EKV2+0 ...	70 G VTJKEZU	95 G VAM7M6H
Part No.	VTJKEZU	VAM7M6H
Cable cross-section	70 mm ²	95 mm ²
Max. short-circuit current I _k 0.5 s	19.5 kA	26.5 kA
Max. short-circuit current I _k 1 s	13.8 kA	18.7 kA

Type EKV2+0 ...	120 G VFV1Z7K	150 G VLL6JWS
Part No.	VFV1Z7K	VLL6JWS
Cable cross-section	120 mm ²	150 mm ²
Max. short-circuit current I _k 0.5 s	33.5 kA	42.0 kA
Max. short-circuit current I _k 1 s	23.7 kA	29.6 kA

Attention: Please state the relevant Variant No. when ordering.

Three-pole Earthing and Short-Circuiting Cables, copper version, same cable cross-section

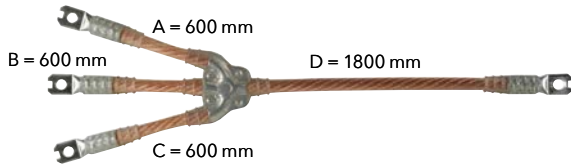

General technical data:	
Material	Cu
Crimped cable lug	PK1

Type EKV3+0 ...	16 G VE5MT89	25 G VNC1S9W
Part No.	VE5MT89	VNC1S9W
Cable cross-section	16 mm ²	25 mm ²
Max. short-circuit current I _k 0.5 s	4.5 kA	7.0 kA
Max. short-circuit current I _k 1 s	3.2 kA	4.9 kA

Type EKV3+0 ...	35 G V18JQHQ	50 G VJ7VGZD
Part No.	V18JQHQ	VJ7VGZD
Cable cross-section	35 mm ²	50 mm ²
Max. short-circuit current I _k 0.5 s	10.0 kA	14.0 kA
Max. short-circuit current I _k 1 s	6.9 kA	9.9 kA

Type EKV3+0 ...	70 G VH95BZZ	95 G VM2J7S3
Part No.	VH95BZZ	VM2J7S3
Cable cross-section	70 mm ²	95 mm ²
Max. short-circuit current I _k 0.5 s	19.5 kA	26.5 kA
Max. short-circuit current I _k 1 s	13.8 kA	18.7 kA

Type EKV3+0 ...	120 G V8D4AQ2	150 G VG3V6T2
Part No.	V8D4AQ2	VG3V6T2
Cable cross-section	120 mm ²	150 mm ²
Max. short-circuit current I _k 0.5 s	33.5 kA	42.0 kA
Max. short-circuit current I _k 1 s	23.7 kA	29.6 kA

Attention: Please state the relevant Variant No. when ordering.

Three-pole Earthing and Short-Circuiting Cables, copper version, reduced cable cross-section

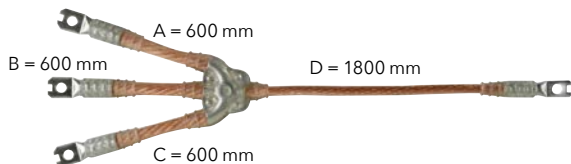

General technical data:	
Material	Cu
Crimped cable lug	PK1

Type EKV3+0 ...	50 R VN35H5D	70 R VTCS2XV
Part No.	VN35H5D	VTCS2XV
Cable cross-section	50/25 mm ²	70/35 mm ²
Max. short-circuit current I _k 0.5 s	14.0 kA	19.5 kA
Max. short-circuit current I _k 1 s	9.9 kA	13.8 kA

Type EKV3+0 ...	95 R VLB2F3G	120 R V8115WA
Part No.	VLB2F3G	V8115WA
Cable cross-section	95/35 mm ²	120/50 mm ²
Max. short-circuit current I _k 0.5 s	26.5 kA	33.5 kA
Max. short-circuit current I _k 1 s	18.7 kA	23.7 kA

Type EKV3+0 ...	150 R V11E77B
Part No.	V11E77B
Cable cross-section	150/50 mm ²
Max. short-circuit current I _k 0.5 s	42.0 kA
Max. short-circuit current I _k 1 s	29.6 kA

Attention: Please state the relevant Variant No. when ordering.

Four-pole Earthing and Short-Circuiting Cables, copper version

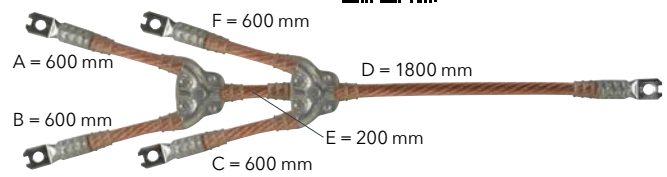

General technical data:	
Material	Cu
Crimped cable lug	PK1

Type EKV4u0 ...	16 G VGUVRRG	25 G VGM214B
Part No.	VGUVRRG	VGM214B
Cable cross-section	16 mm ²	25 mm ²
Max. short-circuit current I _k 0.5 s	4.5 kA	7.0 kA
Max. short-circuit current I _k 1 s	3.2 kA	4.9 kA

Type EKV4u0 ...	35 G V93UVAP	50 G V3NCSSHX
Part No.	V93UVAP	V3NCSSHX
Cable cross-section	35 mm ²	50 mm ²
Max. short-circuit current I _k 0.5 s	10.0 kA	14.0 kA
Max. short-circuit current I _k 1 s	6.9 kA	9.9 kA

Type EKV4u0 ...	70 G V7GN8WU	95 G VABRSSE
Part No.	V7GN8WU	VABRSSE
Cable cross-section	70 mm ²	95 mm ²
Max. short-circuit current I _k 0.5 s	19.5 kA	26.5 kA
Max. short-circuit current I _k 1 s	13.8 kA	18.7 kA

Type EKV4u0 ...	120 G V27E2GP	150 G V291ZZT
Part No.	V27E2GP	V291ZZT
Cable cross-section	120 mm ²	150 mm ²
Max. short-circuit current I _k 0.5 s	33.5 kA	42.0 kA
Max. short-circuit current I _k 1 s	23.7 kA	29.6 kA

Attention: Please state the relevant Variant No. when ordering.

Five-pole Earthing and Short-Circuiting Cables, copper version

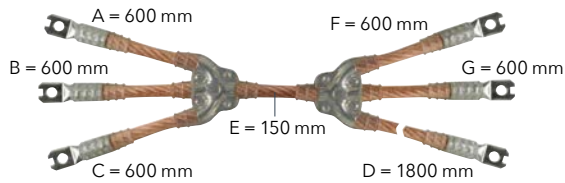

General technical data:

Material	Cu	
Crimped cable lug	PK1	

Type EKV5+0 ...	16 G VQ7PF5A	25 G VZKQZB5
Part No.	VQ7PF5A	VZKQZB5
Cable cross-section	16 mm ²	25 mm ²
Max. short-circuit current I _k 0.5 s	4.5 kA	7.0 kA
Max. short-circuit current I _k 1 s	3.2 kA	4.9 kA

Type EKV5+0 ...	35 G V76D5TH	50 G V6VE249
Part No.	V76D5TH	V6VE249
Cable cross-section	35 mm ²	50 mm ²
Max. short-circuit current I _k 0.5 s	10.0 kA	14.0 kA
Max. short-circuit current I _k 1 s	6.9 kA	9.9 kA

Type EKV5+0 ...	70 G VDXTBGF	95 G VGCMAA5
Part No.	VDXTBGF	VGCMAA5
Cable cross-section	70 mm ²	95 mm ²
Max. short-circuit current I _k 0.5 s	19.5 kA	26.5 kA
Max. short-circuit current I _k 1 s	13.8 kA	18.7 kA

Type EKV5+0 ...	120 G VVL7AKP	150 G VHV1NKR
Part No.	VVL7AKP	VHV1NKR
Cable cross-section	120 mm ²	150 mm ²
Max. short-circuit current I _k 0.5 s	33.5 kA	42.0 kA
Max. short-circuit current I _k 1 s	23.7 kA	29.6 kA

Attention: Please state the relevant Variant No. when ordering.

Phase Connecting Elements for Switchgear Installations

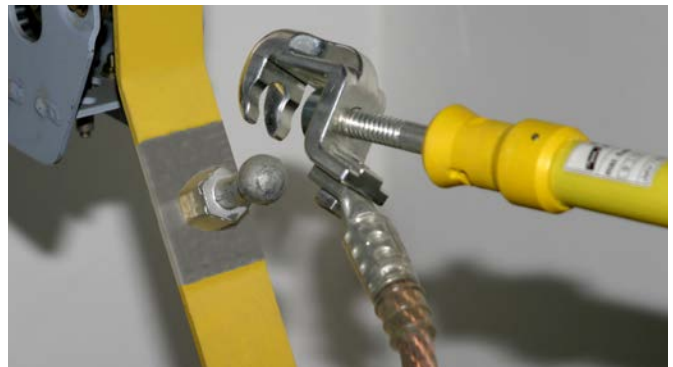

Connecting the phase cable end with universal clamp to a fixed ball point.

- To be fitted to the phase cable end of single-pole to five-pole earthing and short-circuiting devices
- Type PK1 anti-rotation protection
- Other earthing and short-circuiting devices can be configured online via the earthing and short-circuiting configurator

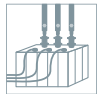

General technical data:

Standard	EN/IEC 61230 (DIN VDE 0683-100), threaded T pin shaft DIN 48087
Temperature range	-25 °C ... +55 °C
Material (clamp body)	Cu alloy/gal Sn
Material (terminal lug)	Cu alloy/gal Sn
Material (shaft)	Cu alloy/gal Sn
Material (pressure plate)	Cu alloy/gal Sn / St/Zn

Two types of ball head caps are available:

- Rigid ball head cap
- Adjustable ball head cap (4x 90°)

The adjustable ball head cap allows the user to connect the earthing and short-circuiting device to fixed ball points that are installed in unfavourable positions. Thus, in the vast majority of cases, angled fixed ball points no longer have to be used.



Rigid ball head cap.

Adjustable ball head cap (4x 90°).

*) Clamping range and maximum cable cross-section of universal clamps used for:

Fixed ball point Ø	T Pin Collar width	Rd / Fl Clamping range	Max. cable cross-section Cu
20 / 25 / 30 mm	15 / 18 mm	20 / 30 mm	16 mm ²
20 / 25 / 30 mm	15 / 18 mm	20 / 30 mm	25 mm ²
20 / 25 / 30 mm	15 / 18 mm	20 / 30 mm	35 mm ²
20 / 25 / 30 mm	15 / 18 mm	20 / 30 mm	50 mm ²
20 / 25 / 30 mm	15 / 18 mm	20 / 30 mm	70 mm ²
20 / 25 / 30 mm	15 / 18 mm	-	95 mm ²
- / 25 / 30 mm	-	-	120 mm ²
-	-	-	150 mm ²

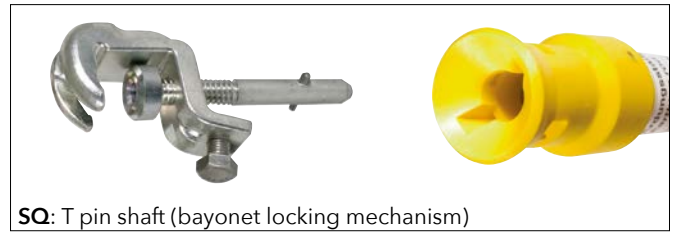

Rigid Ball Head Cap, Hexagon Shaft



Rigid Ball Head Cap, T Pin Shaft



Type	KKH 20 SK	KKH 25 SK
Part No.	772 310	772 320
For fixed ball point Ø	20 mm	25 mm
Anti-rotation protection	PK1	PK1
For cable cross-section Cu	16 ... 120 mm ²	16 ... 150 mm ²
Max. short-circuit current I _k 0.5 s	33.5 kA	42.0 kA
Max. short-circuit current I _k 1 s	23.7 kA	29.6 kA

Type	KKH 20 SQ	KKH 25 SQ
Part No.	772 311	772 321
For fixed ball point Ø	20 mm	25 mm
Anti-rotation protection	PK1	PK1
For cable cross-section Cu	16 ... 120 mm ²	16 ... 150 mm ²
Max. short-circuit current I _k 0.5 s	33.5 kA	42.0 kA
Max. short-circuit current I _k 1 s	23.7 kA	29.6 kA

Adjustable Ball Head Cap (4x 90°), Hexagon Shaft



Adjustable Ball Head Cap (4x 90°), T Pin Shaft



Type	KKH 20 D SK	KKH 25 D SK
Part No.	772 330	772 340
For fixed ball point Ø	20 mm	25 mm
Anti-rotation protection	PK1	PK1
For cable cross-section Cu	16 ... 120 mm ²	16 ... 150 mm ²
Max. short-circuit current I _k 0.5 s	33.5 kA	42.0 kA
Max. short-circuit current I _k 1 s	23.7 kA	29.6 kA

Type	KKH 20 D SQ	KKH 25 D SQ
Part No.	772 331	772 341
For fixed ball point Ø	20 mm	25 mm
Anti-rotation protection	PK1	PK1
For cable cross-section Cu	16 ... 120 mm ²	16 ... 150 mm ²
Max. short-circuit current I _k 0.5 s	33.5 kA	42.0 kA
Max. short-circuit current I _k 1 s	23.7 kA	29.6 kA

Universal Clamp, Hexagon Shaft



Universal Clamp, T Pin Shaft



Type	UK 25 SK	UK 30 SK
Part No.	773 034	773 130
For fixed ball point Ø	20 / 25 mm	25 / 30 mm
For T pins with a collar width of	15 mm	18 mm
Rd / Fl clamping range	20 mm	30 mm
Anti-rotation protection	PK1	PK1
For cable cross-section Cu	16 ... 120 ^{*)} mm ²	16 ... 120 ^{*)} mm ²
Max. short-circuit current I _k 0.5 s	33.5 kA	33.5 kA
Max. short-circuit current I _k 1 s	23.7 kA	23.7 kA

Type	UK 25 SQ	UK 30 SQ
Part No.	773 234	773 330
For fixed ball point Ø	20 / 25 mm	25 / 30 mm
For T pins with a collar width of	15 mm	18 mm
Rd / Fl clamping range	20 mm	30 mm
Anti-rotation protection	PK1	PK1
For cable cross-section Cu	16 ... 120 ^{*)} mm ²	16 ... 120 ^{*)} mm ²
Max. short-circuit current I _k 0.5 s	33.5 kA	33.5 kA
Max. short-circuit current I _k 1 s	23.7 kA	23.7 kA

^{*)} See table for „Clamping range and maximum cable cross-section of universal clamps used for“

^{*)} See table for „Clamping range and maximum cable cross-section of universal clamps used for“

Round Pin Clamp, T Pin Shaft

For round pins in switchgear installations.



General technical data:

Anti-rotation protection	PK1
For cable cross-section Cu	16 ... 150 mm ²
Max. short-circuit current I _k 0.5 s	42.0 kA
Max. short-circuit current I _k 1 s	29.6 kA

Type	RBK 25 SQ SN7151	RBK 26 SQ SN7255
Part No.	715 314	715 315
For round pins Ø	25 mm	26 mm

Type	RBK 30 SQ SN7642	RBK 35 SQ
Part No.	715 313	715 312
For round pins Ø	30 mm	35 mm

Phase Connecting Element, T Pin Shaft

With M16 threaded pin for installation in switchgear installations.



Type	PAS EK SQ 16
Part No.	771 316
Dimensions	M16
Anti-rotation protection	PK1
For cable cross-section Cu	16 ... 150 mm ²
Max. short-circuit current I _k 0.5 s	42.0 kA
Max. short-circuit current I _k 1 s	29.6 kA

The clamps must have the same maximum short-circuit current as the earthing and short-circuiting cables!

Phase Connecting Elements for Overhead Lines



Attaching a phase screw clamp to an overhead line.

- For connecting the phase cables of single-pole and three-pole earthing and short-circuiting devices to overhead lines
- With coupling aid for safe attachment on conductor cables
- Easy coupling due to spring-loaded clamp
- Anti-rotation protection type PK1 or PK2 and long threaded T pin shaft
- Earthing and short-circuiting devices can be configured online via the earthing and short-circuiting configurator



General technical data:

Standard	EN/IEC 61230 (DIN VDE 0683-100), threaded T pin shaft DIN 48087
Temperature range	-25 °C ... +55 °C
Material (pressure plate)	Aluminium alloy
Material (clamp body)	Aluminium alloy
Material (shaft)	Copper alloy/gal Sn or StSt
Material (coupling aid)	St/gal Zn



Spring-loaded phase screw clamp.



Phase screw clamp fitted with fixed coupling aid allows safe coupling.



Clamp with long shaft and earthing stick with aluminium cone coupling.



Crimped cable lug, type **PK1**: Standard anti-rotation cable lug with cut-out.



Crimped cable lug, type **PK2**: Cable lugs without cut-out for connecting parts from other manufacturers are available on request.

Standard Phase Screw Clamp

Short-circuit-proof, even if the conductor cables are corroded due to weathering.



Type	PSK 4 30 SQL	PSK 10 65 SQL
Part No.	784 201	784 301
Clamping range Ø	4 ... 30 mm	10 ... 65 mm
Anti-rotation protection	PK1	PK1
For cable cross-section Cu	16 ... 70 mm ²	16 ... 120 mm ²
Max. short-circuit current I _k 0.5 s	19.5 kA	33.5 kA
Max. short-circuit current I _k 1 s	13.8 kA	23.7 kA

Phase Screw Clamp with Coupling Aid

Short-circuit-proof, even if the conductor cables are corroded due to weathering.



Type	PSK 4 30 SQL EH	PSK 10 65 SQL EH
Part No.	784 401	784 501
Clamping range Ø	4 ... 30 mm	10 ... 65 mm
Anti-rotation protection	PK1	PK1
For cable cross-section Cu	16 ... 70 mm ²	16 ... 120 mm ²
Max. short-circuit current I _k 0.5 s	19.5 kA	33.5 kA
Max. short-circuit current I _k 1 s	13.8 kA	23.7 kA

Spring-loaded Phase Screw Clamp

Easy coupling due to spring-loaded clamp.



Type	PSK FV 4 30 SQL
Part No.	784 480
Clamping range Ø	4 ... 30 mm
Anti-rotation protection	PK1
For cable cross-section Cu	16 ... 70 mm ²
Max. short-circuit current I _k 0.5 s	19.5 kA
Max. short-circuit current I _k 1 s	13.8 kA

Phase Screw Clamp with Wide Clamping Range

Ideally suited for use with Al and Al/St conductor cables, pipes and fixed phase points.



Type	PSK 10 85 SQL
Part No.	784 085
Clamping range Ø	10 ... 85 mm
Anti-rotation protection	PK2
For cable cross-section Cu	16 ... 150 mm ²
Max. short-circuit current I _k 0.5 s	29.6 kA
Max. short-circuit current I _k 1 s	29.6 kA

Phase Screw Clamp with Wide Clamping Range and Telescopic Earthing Stick

Ideally suited for use with Al and Al/St conductor cables, pipes and fixed phase points.



Type	ESTC PSK 5000 SN7249
Part No.	769 511
Clamping range Ø	10 ... 85 mm
Anti-rotation protection	PK2
For cable cross-section Cu	16 ... 150 mm ²
Max. short-circuit current I _k 0.5 s	29.6 kA
Max. short-circuit current I _k 1 s	29.6 kA
Total length (l _{G max} / l _{G min})	5200 / 2875 mm
Length (handle)	1900 mm

Phase Screw Clamp

Ideally suited for use in inclined positions.



Type	PSK 10 32 SQL
Part No.	784 032
Clamping range Ø	10 ... 32 mm
Anti-rotation protection	PK2
For cable cross-section Cu	16 ... 95 mm ²
Max. short-circuit current I _k 0.5 s	18.7 kA
Max. short-circuit current I _k 1 s	18.7 kA

Phase Screw Clamp with Safety Bow

Ideally suited for use in inclined positions.



Type	PSK 10 32 SQL SB
Part No.	784 038
Clamping range Ø	10 ... 32 mm
Anti-rotation protection	PK2
For cable cross-section Cu	16 ... 95 mm ²
Max. short-circuit current I _k 0.5 s	18.7 kA
Max. short-circuit current I _k 1 s	18.7 kA

Rigid Ball Head Cap



Type	KKH 20 SQL	KKH 25 SQL
Part No.	772 314	772 324
For fixed ball point Ø	20 mm	25 mm
Anti-rotation protection	PK1	PK1
For cable cross-section Cu	16 ... 120 mm ²	16 ... 150 mm ²
Max. short-circuit current I _k 0.5 s	33.5 kA	42.0 kA
Max. short-circuit current I _k 1 s	23.7 kA	29.6 kA

Universal Clamp



Type	UK 25 SQL	UK 30 SQL
Part No.	773 236	773 331
For fixed ball point Ø	20 / 25 mm	25 / 30 mm
For T pins with a collar width of	15 mm	18 mm
Rd / Fl clamping range	20 mm	30 mm
Anti-rotation protection	PK1	PK1
For cable cross-section Cu	16 ... 120 ^{*)} mm ²	16 ... 120 ^{*)} mm ²
Max. short-circuit current I _k 0.5 s	33.5 kA	33.5 kA
Max. short-circuit current I _k 1 s	23.7 kA	23.7 kA

*) See table for „Clamping range and maximum cable cross-section of universal clamps used for“

The clamps must be designed for the same maximum short-circuit current as the earthing and short-circuiting cables!

Accessories for Phase Connecting Elements for Overhead Lines

Two-pole phase connecting plate

Allows to connect two phase screw clamps with PK1 anti-rotation element.



Type	PAP 2 M12 SSM B13
Part No.	728 312
Anti-rotation cable lug	PK1
Borehole	Ø12.5 mm
Max. short-circuit current I _k 0.5 s	33.5 kA
Max. short-circuit current I _k 1 s	23.7 kA

Three-pole phase connecting plate with round pin

Phase connecting plate for phase clamps.



Type	PAP 3 M12 SSM B13 RB
Part No.	728 313
Anti-rotation cable lug	PK1
Borehole	Ø12.5 mm
Max. short-circuit current I _k 0.5 s	33.5 kA
Max. short-circuit current I _k 1 s	23.7 kA

*) Clamping range and maximum cable cross-section of universal clamps used for:

Fixed ball point Ø	T Pin Collar width	Rd / Fl Clamping range	Max. cable cross-section Cu
20 / 25 / 30 mm	15 / 18 mm	20 / 30 mm	16 mm ²
20 / 25 / 30 mm	15 / 18 mm	20 / 30 mm	25 mm ²
20 / 25 / 30 mm	15 / 18 mm	20 / 30 mm	35 mm ²
20 / 25 / 30 mm	15 / 18 mm	20 / 30 mm	50 mm ²
20 / 25 / 30 mm	15 / 18 mm	20 / 30 mm	70 mm ²
20 / 25 / 30 mm	15 / 18 mm	–	95 mm ²
– / 25 / 30 mm	–	–	120 mm ²
–	–	–	150 mm ²

Earthing Kit



Earthing busbar and earthing cables mounted on a tubular earth electrode.

- For overhead line systems
- For driving the tubular earth electrode into the ground

General technical data:

Material (tubular earth electrode)	HDG steel
Material (bolt)	StSt (V2A)
Material (handle)	Wood
Material (earthing busbar)	HDG steel



Crimped cable lugs, type **PK3**:
Anti-rotation hook-type cable lug mounted on a three-pole earthing busbar.

Earthing Kit

For three-pole earthing devices.

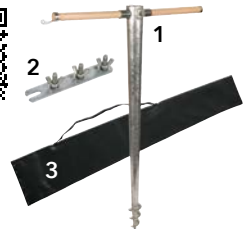

Kit includes:

No.	Part No.	No.	Part No.
1	644 000	3	766 601
2	799 019		

For more information about the articles, see www.dehn-international.com

Type	ES 3P FLER
Part No.	799 009
Total length (l _G)	1000 mm
Bolt	M10 x 35 mm

Accessories for Earthing Kit

Tubular earth electrode with drill



Type	ERO BSP ASSM10 ...	1000 STTZN
Part No.		644 000
Length (drill)		1000 mm
Stock No.		5975-12-120-0006

Three-pole earthing busbar

With slot for mounting the earthing busbar on the tubular earth electrode, for hook-type cable lugs of type PK3.



Type	ESS 3P M10 FM
Part No.	799 019
Dimensions	180 x 30 x 5 mm
Bolt	3x M10 x 35 mm

Earthing Spike



Earthing spike with coiled earthing cable.

- To be driven into the soil
- Two half-shells for earthing or extension cables
- Hot-dip galvanised version

General technical data:

Material	HDG steel
Material (bolt)	St/St

Earthing Spike



Type	ESP HVS 1500
Part No.	799 006
Total length (l _G)	1500 mm
Bolt	M12 x 25 mm

Earth Connecting Elements for Switchgear Installations and Overhead Lines



Earth bushing with tommy bar on a fixed earthing point with ring groove.

- For connecting the earth cable end to fixed ball points, T pins, round and flat conductors, connecting elements and flat profiles
- For wide clamping ranges up to 40 mm
- Anti-rotation protection of type PK1 or PK2
- Earthing and short-circuiting devices can be configured online by means of the earthing and short-circuiting configurator

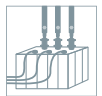

General technical data:

Standard	EN/IEC 61230 (DIN VDE 0683-100)
Temperature range	-25 °C ... +55 °C
Material (clamp body)	Cu alloy/gal Sn / MCl/gal Zn
Material (shaft)	Cu alloy/gal Sn / brass/gal Zn
Material (pressure plate)	Cu alloy/gal Sn / St/gal Zn
Material (terminal lug)	E-Cu/gal Sn
Material (wing nut)	Cu alloy/gal Sn
Material (milling plate)	Hardened/nikel-plated steel
Material (spring)	Spring steel

Universal Clamp with Wing Bolt



Type	UEK 25 FS	UEK 30 FS
Part No.	774 034	774 130
For fixed ball point Ø	20 / 25 mm	25 / 30 mm
For T pins with a collar width of	15 mm	18 mm
Rd / Fl clamping range	20 mm	30 mm
Anti-rotation cable lug	PK1	PK1
For cable cross-section Cu	16 ... 120 ^{*)} mm ²	16 ... 120 ^{*)} mm ²
Max. short-circuit current I _k 0.5 s	33.5 kA	33.5 kA
Max. short-circuit current I _k 1 s	23.7 kA	23.7 kA

^{*)} See table for „Clamping range and maximum cable cross-section of universal clamps used for“

Universal Clamp with Handle



Type	UEK 25 HG	UEK 30 HG
Part No.	774 234	774 330
For fixed ball point Ø	20 / 25 mm	25 / 30 mm
For T pins with a collar width of	15 mm	18 mm
Rd / Fl clamping range	20 mm	30 mm
Anti-rotation cable lug	PK1	PK1
For cable cross-section Cu	16 ... 120 ^{*)} mm ²	16 ... 120 ^{*)} mm ²
Max. short-circuit current I _k 0.5 s	33.5 kA	33.5 kA
Max. short-circuit current I _k 1 s	23.7 kA	23.7 kA

^{*)} See table for „Clamping range and maximum cable cross-section of universal clamps used for“

Universal Clamp with Tommy Bar



Type	UEK 25 SKN	UEK 30 SKN
Part No.	774 434	774 530
For fixed ball point Ø	20 / 25 mm	30 mm
For T pins with a collar width of	15 mm	18 mm
Rd / Fl clamping range	20 mm	30 mm
Anti-rotation cable lug	PK1	PK1
For cable cross-section Cu	16 ... 120 ^{*)} mm ²	16 ... 120 ^{*)} mm ²
Max. short-circuit current I _k 0.5 s	33.5 kA	33.5 kA
Max. short-circuit current I _k 1 s	23.7 kA	23.7 kA

^{*)} See table for „Clamping range and maximum cable cross-section of universal clamps used for“

Rigid Ball Head Cap with Wing Bolt



Type	KKH 20 FS	KKH 25 FS
Part No.	772 312	772 322
For fixed ball point Ø	20 mm	25 mm
Anti-rotation cable lug	PK1	PK1
For cable cross-section Cu	16 ... 120 mm ²	16 ... 150 mm ²
Max. short-circuit current I _k 0.5 s	33.5 kA	42.0 kA
Max. short-circuit current I _k 1 s	23.7 kA	29.6 kA

Rigid Ball Head Cap with Handle



Type	KKH 20 HG	KKH 25 HG
Part No.	772 313	772 323
For fixed ball point Ø	20 mm	25 mm
Anti-rotation cable lug	PK1	PK1
For cable cross-section Cu	16 ... 120 mm ²	16 ... 150 mm ²
Max. short-circuit current I _k 0.5 s	33.5 kA	42.0 kA
Max. short-circuit current I _k 1 s	23.7 kA	29.6 kA

Earth Connecting Element with Wing Nut



Type	EAS EK FM 12	EAS EK FM 16
Part No.	775 621	775 631
Dimensions	M12	M16
Anti-rotation cable lug	PK1	PK1
For cable cross-section Cu	16 ... 150 mm ²	16 ... 150 mm ²
Max. short-circuit current I _k 0.5 s	42.0 kA	42.0 kA
Max. short-circuit current I _k 1 s	29.6 kA	29.6 kA

Earth Connecting Element with Wing Bolt



Type	EAS EK FS 12	EAS EK FS 16
Part No.	775 626	775 636
Dimensions	M12 x 15 mm	M16 x 15 mm
Anti-rotation cable lug	PK1	PK1
For cable cross-section Cu	16 ... 150 mm ²	16 ... 150 mm ²
Max. short-circuit current I _k 0.5 s	42.0 kA	42.0 kA
Max. short-circuit current I _k 1 s	29.6 kA	29.6 kA

Earth Bushing with Wing Bolt

For fixed earthing points with ring groove



Type	EAB RN 16 FS
Part No.	790 150
Dimensions	Ø16 mm
Anti-rotation cable lug	PK1
For cable cross-section Cu	16 ... 150 ^{*)} mm ²
Max. short-circuit current I _k 0.5 s	42.0 kA
Max. short-circuit current I _k 1 s	29.6 kA

^{*)} For cable lengths > 4000 mm: max. up to 95 mm² (26.5 kA / 0.5 s).

Earth Bushing with Tommy Bar

For fixed earthing points with ring groove



Type	EAB RN 16 SKN
Part No.	790 160
Dimensions	Ø16 mm
Anti-rotation cable lug	PK2
For cable cross-section Cu	16 ... 150 ^{**)} mm ²
Max. short-circuit current I _k 0.5 s	29.6 kA
Max. short-circuit current I _k 1 s	29.6 kA

^{**)} Max. short-circuit current of 29.6 kA even in case of a disconnection time I_k of 1 s.

Earth Milling Clamp with Tommy Bar and Disc Springs

Milling plate, disc springs and long tommy bar for reliable contact



Type	EFK FL40 SKN
Part No.	792 190
Clamping range	up to 40 mm
Anti-rotation cable lug	PK1
For cable cross-section Cu	16 ... 95 mm ²
Max. short-circuit current I _k 0.5 s	26.5 kA
Max. short-circuit current I _k 1 s	18.7 kA

Earth Milling Clamp with Tommy Bar

Milling plate and long tommy bar for reliable contact



Type	EFK FL30 SKN
Part No.	792 030
Clamping range	Up to 30 mm
Anti-rotation cable lug	PK1
For cable cross-section Cu	16 ... 50 mm ²
Max. short-circuit current I _k 0,5 s	14.0 kA
Max. short-circuit current I _k 1 s	9.9 kA

The clamps must have the same maximum short-circuit current as the earthing and short-circuiting cables!

***) Clamping range and maximum cable cross-section of universal clamps used for:**

Fixed ball point Ø	T Pin Collar width	Rd / Fl Clamping range	Max. cable cross-section Cu
20 / 25 / 30 mm	15 / 18 mm	20 / 30 mm	16 mm ²
20 / 25 / 30 mm	15 / 18 mm	20 / 30 mm	25 mm ²
20 / 25 / 30 mm	15 / 18 mm	20 / 30 mm	35 mm ²
20 / 25 / 30 mm	15 / 18 mm	20 / 30 mm	50 mm ²
20 / 25 / 30 mm	15 / 18 mm	20 / 30 mm	70 mm ²
20 / 25 / 30 mm	15 / 18 mm	–	95 mm ²
– / 25 / 30 mm	–	–	120 mm ²
–	–	–	150 mm ²

Earthing Sticks for Switchgear Installations

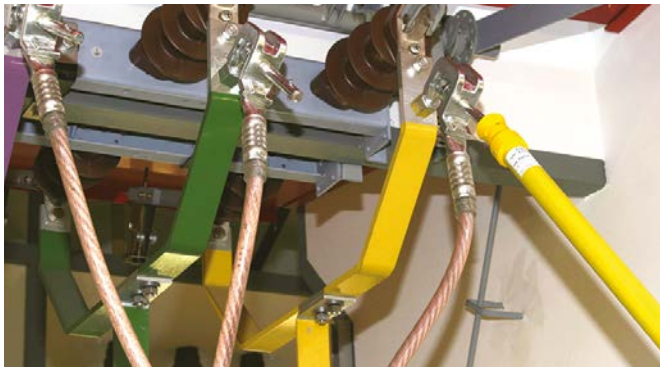

Earthing stick used for attaching an earthing and short-circuiting device to an installation.

- For attaching earthing and short-circuiting devices
- Available in different lengths
- Modular for easy transport
- Light-weight construction
- Hexagon shaft (WS 19 mm) or T pin shaft



General technical data:

Standard	T pin shaft DIN 48087
Temperature range	-25 °C ... +55 °C
Material (insulating tube)	Glass-fibre reinforced polyester tube
End fitting	Non-slip plastic cap or plug-in coupling for extending the handle



Earthing sticks with bayonet locking mechanism (T pin shaft) can also be used for clamps with hexagon shaft by attaching an AES SQ SK adapter.



The plug-in coupling allows for easy handle extension of ES STK earthing sticks.

Earthing sticks are hand-held insulating sticks for approaching clamps of earthing and short-circuiting devices to parts of electrical installations for earthing and short-circuiting purposes. They consist of an insulating element, black ring, handle and coupling for attaching clamps. Earthing sticks have to be selected according to the **weight** of the earthing and short-circuiting device.

The **insulating element** is the part of the earthing stick between the black ring and the end of the earthing stick in the direction of the clamp. It ensures that the user maintains the required safety distance and provides sufficient insulation. In installations exceeding 1 kV, the insulating element must have a minimum length of 500 mm.

With hexagon shaft

Handle termination with end cap (spring locking mechanism)



Type	ES SK 1000	ES SK 1500
Part No.	761 010	761 015
Total length (l _G)	1000 mm	1500 mm
Length (handle) (l _H)	430 mm	930 mm

With T pin shaft

Handle termination with end cap (bayonet locking mechanism)



Type	ES SQ 1000	ES SQ 1500
Part No.	761 011	761 016
Total length (l _G)	1000 mm	1500 mm
Length (handle) (l _H)	430 mm	930 mm

With hexagon shaft, plug-in coupling

Handle termination with plastic plug-in coupling for extending the handle (spring locking mechanism)



Type	ES SK STK 1000	ES SK STK 2000
Part No.	761 001	761 003
Total length (l _G)	1000 mm	2000 mm
Length (handle) (l _H)	430 mm	1430 mm

With T pin shaft, plug-in coupling

Handle termination with plastic plug-in coupling for extending the handle (bayonet locking mechanism)



Type	ES SQ STK 1000	ES SQ STK 2000
Part No.	761 002	761 004
Total length (l _G)	1000 mm	2000 mm
Length (handle) (l _H)	430 mm	1430 mm

Telescopic with T pin shaft and plug-in coupling

Handle termination with plastic plug-in coupling for extending the handle (bayonet locking mechanism)



Type	ESTC SQ STK SN7562
Part No.	769 304
Total length (l _{G max} / l _{G min})	3040 / 1790 mm
Length (handle) (l _H)	900 mm

Two-part, with hexagon shaft

Handle termination with plastic plug-in coupling for extending the handle (spring locking mechanism)



Type	EST SK STK 920
Part No.	761 070
Total length (l _G)	920 mm
Length (handle) (l _H)	415 mm

Two-part, with T pin shaft

Handle termination with plastic plug-in coupling for extending the handle (bayonet locking mechanism)



Type	EST SQ STK 920
Part No.	761 075
Total length (l _G)	920 mm
Length (handle) (l _H)	415 mm

Accessories for Earthing Sticks for Switchgear Installations

Adapter (T pin shaft / hexagon shaft)

Suitable for putting on earthing sticks with coupling for T pin shaft (bayonet locking mechanism). The lock nut enables the adapter to be fixed to the earthing stick.



Type	AD ES SQ SK
Part No.	765 001
Length	130 mm

Earthing Sticks for Overhead Lines



Telescopic earthing stick with aluminium cone coupling and phase screw clamp.

- For outdoor use
- Robust aluminium cone coupling
- Total lengths up to 6000 mm
- Telescopic stick, length continuously adjustable by star knob
- For phase screw clamps and clamps with long T pin shaft



General technical data:

Temperature range	-25 °C ... +55 °C
Material (insulating tube)	Glass-fibre reinforced polyester tube
Material (threaded coupling, star knob)	Aluminium alloy
End fitting	Aluminium/rubber eye / Plug-in coupling for extending the handle

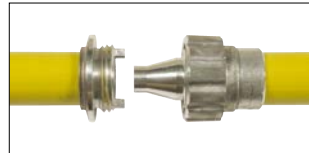

Robust aluminium threaded coupling allows positive and non-positive connection due to the screw connection and gearing.



End fitting with eye (Al/rubber) or plug-in coupling with eye (Al/rubber) for extending the handle.

A square tube (26 mm) can be pulled out of the round insulating tube and can be fixed in any position between l_{min} and l_{max} using the star knob.

Lockable adjusting ring:

- The adjusting ring on the cone has the following functions:
 - Position "AUF" (= OPEN): Stick can be removed after the clamp has been attached
 - Position "ZU" (= CLOSED): Stick and clamp remain coupled even after the earthing and short-circuiting device has been attached



Permissible loads for the earthing sticks:

Length l _G	No.	Max. load on the operating head
6000 mm	1+2+2+3	3.5 kg
4500 mm	1+2+3	10 kg
3000 mm	1+3	10 kg
1500 mm	1	20 kg

Telescopic, with T pin shaft



□26 mm			Ø43 mm
Type	ESTC SQL 4000	ESTC SQL 5000	
Part No.	769 400	769 500	
Total length (l _{G max} / l _{G min})	4015 / 2180 mm	5015 / 2680 mm	
Length (handle) (l _H)	1400 mm	1900 mm	
Diameter	43 mm	43 mm	

Telescopic, with T pin shaft, plug-in coupling



Ø43 mm		
Type	ESTC SQL STK 3000	
Part No.	769 300	
Total length (l _{G max} / l _{G min})	3015 / 1760 mm	
Length (handle) (l _H)	900 mm	
Diameter	43 mm	

Multi-part, top section

With aluminium bayonet coupling and aluminium threaded coupling as end fitting.



1			Ø43 mm
Type	EST KS SQL 1500		
Part No.	769 503		
Total length (l _G)	1600 mm		
Diameter	43 mm		

Multi-part, intermediate section

With aluminium threaded coupling, connector with nut and bushing.



2			Ø43 mm
Type	EST ZS 1500		
Part No.	769 504		
Total length (l _G)	1580 mm		
Diameter	43 mm		

Multi-part, end fitting

With connector and nut of the aluminium threaded coupling and end fitting with ring eye.



3			Ø43 mm
Type	EST ES 1500		
Part No.	769 505		
Total length (l _G)	1590 mm		
Diameter	43 mm		

Accessories for Earthing Sticks for Overhead Lines

Adapter (T pin shaft / long T pin shaft)

Suitable for insertion into earthing sticks with aluminium cone coupling for T pin shafts (bayonet locking mechanism) to accept clamps with T pin shaft. The lock nut allows to fix the adapter on the earthing stick.



Type	AD ES SQ SQL
Part No.	765 006
Length	185 mm

EaS Configurator: Easy online configuration



You will find the EaS configurator at de.hn/4T1Uq

- Easy online selection of the suitable EaS device
- Unique laser marking of the EaS device
- Individual configuration
- Permanent plausibility check in the background
- User-friendly interface
- To start the configuration, simply enter the Variant No., Part No. or Product configuration



General technical data:

Standard	EN/IEC 61138 (DIN VDE 0283-3) and EN/IEC 61230 (DIN VDE 0683-100)
Temperature range	-25 °C ... +55 °C
Material (cable)	Al, flexible; E-Cu, extra finely stranded and highly flexible
Material (sheath)	Thermoplastic (soft PVC compound YM2)
Hole (terminal lug)	Ø12.5 mm

Earthing and short-circuiting devices (EaS) for switchgear installations and overhead line application can be individually configured online on the DEHN homepage.

The configurator provides you with two options to start the configuration (product or system view).

The product view is ideally suited for users who know exactly what they need and already have a concrete idea of, for example, the cable cross-section and clamps to be used.

As an alternative, the system view can be selected. For this extended version of the product view, information on the installation must be provided.

The application location of the EaS device determines which clamps are ultimately available for selection. A distinction is made here between switchgear installations and overhead line systems.

A permanent plausibility check ensures reliable selection of the right device. Further accessories such as earthing sticks are optionally displayed for the configured EaS devices.

At the end of the configuration the result is shown graphically and in a detailed description. In addition, a unique Variant No. is assigned to the application-specific earthing and short-circuiting device, which is lasered on the device later.

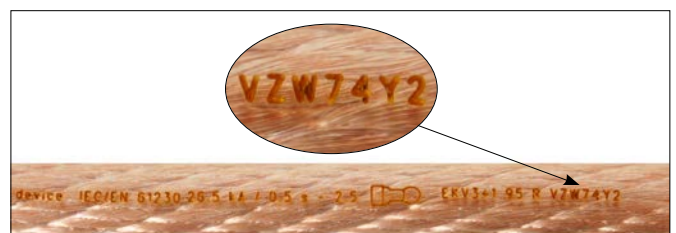

The EaS configurator is graphically divided into three parts:

- On the left, the modular features are displayed in a tree structure. The selection history is shown, and you can jump back to it at any time and change properties that have already been selected. The tree structure allows a clearly structured configuration.
- In the centre you can select or change the required information via the keyboard or mouse. This usually happens "step by step", i.e. only after a property has been evaluated is the next characteristic "visible" and selectable.
- On the right, the current status is graphically displayed in an active visualisation in order to support and simplify the right selection. Here too, data can be entered in the relevant fields.

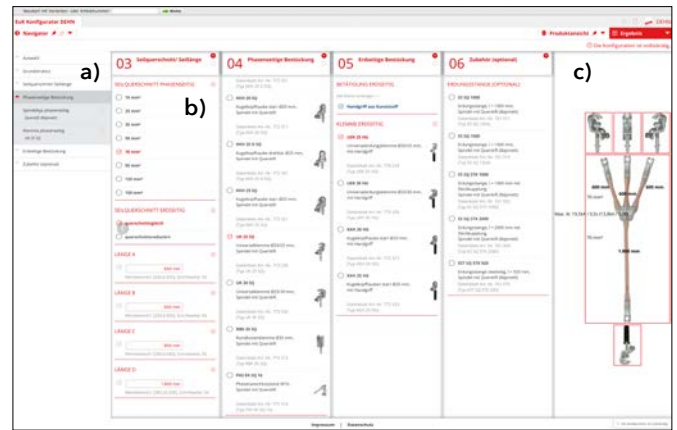

**Three-pole,
same Cable Cross-Section
with Ball Head Caps**

... easy configuration ...

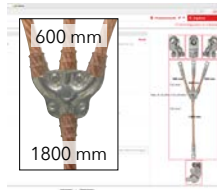

General technical data:	
Earth cable end	EAS EK FM 12

Type EKV3+1 ...	16 G VGJD2QX	25 G VRDSN66
Part No.	VGJD2QX	VRDSN66
Phase cable end	KKH 20 SK	KKH 20 SK
For fixed ball point Ø	20 mm	20 mm
Cable cross-section Cu	16 mm ²	25 mm ²
Max. short-circuit current I _k 0.5 s	4.5 kA	7.0 kA
Max. short-circuit current I _k 1 s	3.2 kA	4.9 kA

Type EKV3+1 ...	35 G V3WJMY	50 G VU8P6LE
Part No.	V3WJMY	VU8P6LE
Phase cable end	KKH 20 SK	KKH 20 SK
For fixed ball point Ø	20 mm	20 mm
Cable cross-section Cu	35 mm ²	50 mm ²
Max. short-circuit current I _k 0.5 s	10.0 kA	14.0 kA
Max. short-circuit current I _k 1 s	6.9 kA	9.9 kA

Type EKV3+1 ...	70 G VCEY1U6	95 G VA3926U
Part No.	VCEY1U6	VA3926U
Phase cable end	KKH 20 SK	KKH 20 SK
For fixed ball point Ø	20 mm	20 mm
Cable cross-section Cu	70 mm ²	95 mm ²
Max. short-circuit current I _k 0.5 s	19.5 kA	26.5 kA
Max. short-circuit current I _k 1 s	13.8 kA	18.7 kA

Type EKV3+1 ...	120 G VAB3PJV	150 G V1KPXFR
Part No.	VAB3PJV	V1KPXFR
Phase cable end	KKH 20 SK	KKH 25 SK
For fixed ball point Ø	20 mm	25 mm
Cable cross-section Cu	120 mm ²	150 mm ²
Max. short-circuit current I _k 0.5 s	33.5 kA	42.0 kA
Max. short-circuit current I _k 1 s	23.7 kA	29.6 kA

**Three-pole,
reduced Cable Cross-Section
with Ball Head Caps**

... easy configuration ...



General technical data:	
Earth cable end	EAS EK FM 12

Type EKV3+1 ...	50 R VD28FAD	70 R VQYP8B2
Part No.	VD28FAD	VQYP8B2
Phase cable end	KKH 20 SK	KKH 20 SK
For fixed ball point Ø	20 mm	20 mm
Cable cross-section Cu	50/25 mm ²	70/35 mm ²
Max. short-circuit current I _k 0.5 s	14.0 kA	19.5 kA
Max. short-circuit current I _k 1 s	9.9 kA	13.8 kA

Type EKV3+1 ...	95 R V5SVXPH	120 R VTSY9XH
Part No.	V5SVXPH	VTSY9XH
Phase cable end	KKH 20 SK	KKH 20 SK
For fixed ball point Ø	20 mm	20 mm
Cable cross-section Cu	95/35 mm ²	120/50 mm ²
Max. short-circuit current I _k 0.5 s	26.5 kA	33.5 kA
Max. short-circuit current I _k 1 s	18.7 kA	23.7 kA

Type EKV3+1 ...	150 R VHBWUNH
Part No.	VHBWUNH
Phase cable end	KKH 25 SK
For fixed ball point Ø	25 mm
Cable cross-section Cu	150/50 mm ²
Max. short-circuit current I _k 0.5 s	42.0 kA
Max. short-circuit current I _k 1 s	29.6 kA

Three-pole, same Cable Cross-Section with Universal Clamp

... easy configuration ...

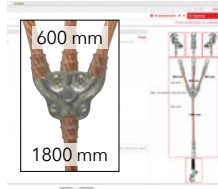

General technical data:	
Phase cable end	UK 25 SQ
Earth cable end	UEK 25 HG
For fixed ball point Ø	20 / 25 mm
For T pins with a collar width of	15 mm
Rd / Fl clamping range	20 mm

Type EKV3+1 ...	16 G V8MCNWM	25 G V8VF7CP
Part No.	V8MCNWM	V8VF7CP
Cable cross-section Cu	16 mm ²	25 mm ²
Max. short-circuit current I _k 0.5 s	4.5 kA	7.0 kA
Max. short-circuit current I _k 1 s	3.2 kA	4.9 kA

Type EKV3+1 ...	35 G V5VN56Z	50 G VPH98CT
Part No.	V5VN56Z	VPH98CT
Cable cross-section Cu	35 mm ²	50 mm ²
Max. short-circuit current I _k 0.5 s	10.0 kA	14.0 kA
Max. short-circuit current I _k 1 s	6.9 kA	9.9 kA

Type EKV3+1 ...	70 G VMLM2BZ	95 G VE9HQHJ
Part No.	VMLM2BZ	VE9HQHJ
Cable cross-section Cu	70 mm ²	95 mm ²
Max. short-circuit current I _k 0.5 s	19.5 kA	26.5 kA
Max. short-circuit current I _k 1 s	13.8 kA	18.7 kA

Type EKV3+1 ...	120 G VKZLVU3
Part No.	VKZLVU3
Cable cross-section Cu	120 mm ²
Max. short-circuit current I _k 0.5 s	33.5 kA
Max. short-circuit current I _k 1 s	23.7 kA

Three-pole, reduced Cable Cross-Section with Universal Clamp

... easy configuration ...



General technical data:	
Phase cable end	UK 25 SQ
Earth cable end	UEK 25 HG
For fixed ball point Ø	20 / 25 mm
For T pins with a collar width of	15 mm
Rd / Fl clamping range	20 mm

Type EKV3+1 ...	50 R VMBDCM1	70 R V4RJ7A2
Part No.	VMBDCM1	V4RJ7A2
Cable cross-section Cu	50/25 mm ²	70/35 mm ²
Max. short-circuit current I _k 0.5 s	14.0 kA	19.5 kA
Max. short-circuit current I _k 1 s	9.9 kA	13.8 kA

Type EKV3+1 ...	95 R VRAB9WB	120 R VACNLP8
Part No.	VRAB9WB	VACNLP8
Cable cross-section Cu	95/35 mm ²	120/50 mm ²
Max. short-circuit current I _k 0.5 s	26.5 kA	33.5 kA
Max. short-circuit current I _k 1 s	18.7 kA	23.7 kA

Single-pole with Phase Screw Clamp

... easy configuration ...

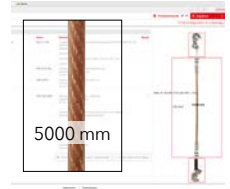

Type EKV1+1 ...	16 VE5E8FZ	25 VF33XR2
Part No.	VE5E8FZ	VF33XR2
Phase cable end	PSK 4 30 SQL	PSK 4 30 SQL
Earth cable end	EFK FL40 SKN	EFK FL40 SKN
Clamping range Ø	4 ... 30 mm	4 ... 30 mm
Cable cross-section Cu	16 mm ²	25 mm ²
Max. short-circuit current I _k 0.5 s	4.5 kA	7.0 kA
Max. short-circuit current I _k 1 s	3.2 kA	4.9 kA

Type EKV1+1 ...	35 V43FCV8	50 V2KWXUL
Part No.	V43FCV8	V2KWXUL
Phase cable end	PSK 4 30 SQL	PSK 4 30 SQL
Earth cable end	EFK FL40 SKN	EFK FL40 SKN
Clamping range Ø	4 ... 30 mm	4 ... 30 mm
Cable cross-section Cu	35 mm ²	50 mm ²
Max. short-circuit current I _k 0.5 s	10.0 kA	14.0 kA
Max. short-circuit current I _k 1 s	6.9 kA	9.9 kA

Type EKV1+1 ...	70 VRP32FL	95 V2WPYVF	120 VG4GXHQ
Part No.	VRP32FL	V2WPYVF	VG4GXHQ
Phase cable end	PSK 4 30 SQL	PSK 10 65 SQL	PSK 10 65 SQL
Earth cable end	EFK FL40 SKN	UEK 30 HG	UEK 30 HG
Clamping range Ø	4 ... 30 mm	10 ... 65 mm	10 ... 65 mm
Cable cross-section Cu	70 mm ²	95 mm ²	120 mm ²
Max. short-circuit current I _k 0.5 s	19.5 kA	26.5 kA	33.5 kA
Max. short-circuit current I _k 1 s	13.8 kA	18.7 kA	23.7 kA

Single-pole with Universal Clamp

... easy configuration ...

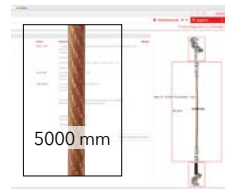

General technical data:	
Phase cable end	UK 25 SQ
Earth cable end	UEK 30 HG
For fixed ball point Ø	20 / 25 mm
For T pins with a collar width of	15 mm
Rd / Fl clamping range	20 mm

Type EKV1+1 ...	16 VMZDL8N	25 VB1DETL
Part No.	VMZDL8N	VB1DETL
Cable cross-section Cu	16 mm ²	25 mm ²
Max. short-circuit current I _k 0.5 s	4.5 kA	7.0 kA
Max. short-cir. current I _k 1 s	3.2 kA	4.9 kA

Type EKV1+1 ...	35 V8PPJEF	50 VQY44GL
Part No.	V8PPJEF	VQY44GL
Cable cross-section Cu	35 mm ²	50 mm ²
Max. short-circuit current I _k 0.5 s	10.0 kA	14.0 kA
Max. short-cir. current I _k 1 s	6.9 kA	9.9 kA

Type EKV1+1 ...	70 VFZ17TJ	95 VWBDMP5	120 V3CM9FR
Part No.	VFZ17TJ	VWBDMP5	V3CM9FR
Cable cross-section Cu	70 mm ²	95 mm ²	120 mm ²
Max. short-circuit current I _k 0.5 s	19.5 kA	26.5 kA	33.5 kA
Max. short-cir. current I _k 1 s	13.8 kA	18.7 kA	23.7 kA

Short-Circuiting Bar

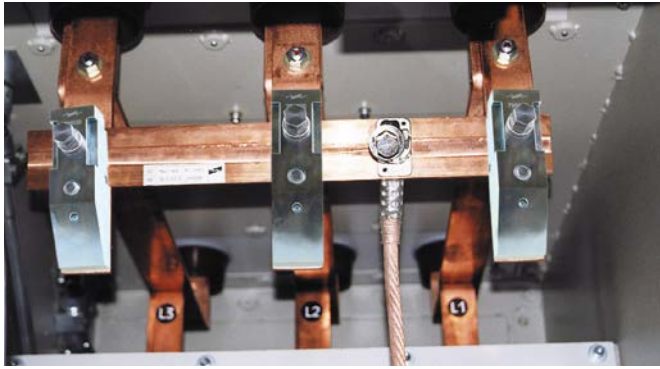

Short-circuiting bar with earthing cable on a switchgear installation.

- Simply compile the right short circuit bar online
- Individual configuration
- Permanent plausibility check in the background
- With longitudinal slot for reliable contact
- High short-circuit current strength up to max. 130 kA / 0.5 s for low-voltage systems (LV) and 80 kA / 0.5 s for medium-voltage systems (MV)
- For use with earthing sticks for hexagon or T pin shafts
- Short-circuiting bar and earthing cable lengths can be selected online via the earthing and short-circuiting configurator



In order to connect the earthing cable to the earthing system, it is fitted with a rigid ball head cap with a wing bolt for fixed ball points (Ø20 mm) (Part No. 772 312 (type KKH 20 FS)). Other equipment or cable lengths can be selected online via the earthing and short-circuiting configurator. Short-circuiting bars are available with two different coupling mechanisms for earthing sticks:

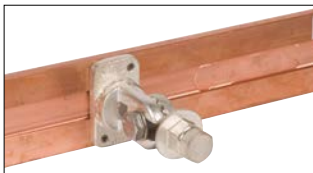

SK: Hexagon shaft.

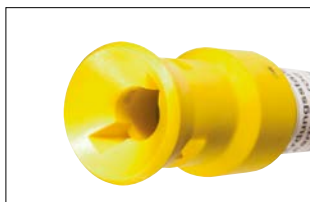
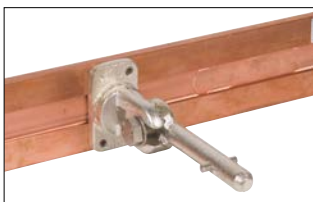

SQ: T pin shaft (bayonet locking mechanism).

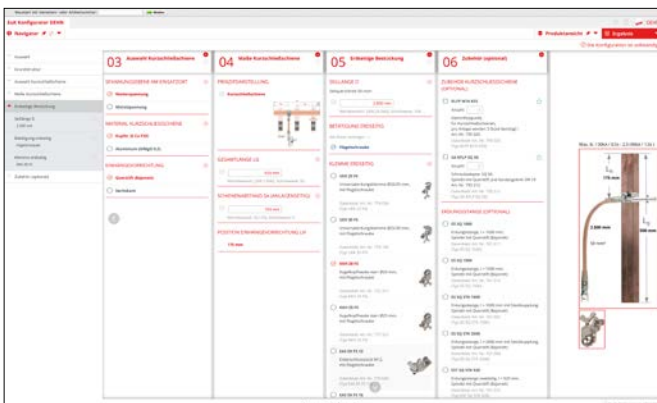

You will find the EaS configurator at: de.hn/8C6wt

General technical data:

Standard	EN/IEC 61230 (DIN VDE 0683-100)
Temperature range	-25 °C ... +55 °C
Profile dimensions	60 x 12 mm
Material (earthing cable)	Highly flexible copper
Cable cross-section	50 mm ²

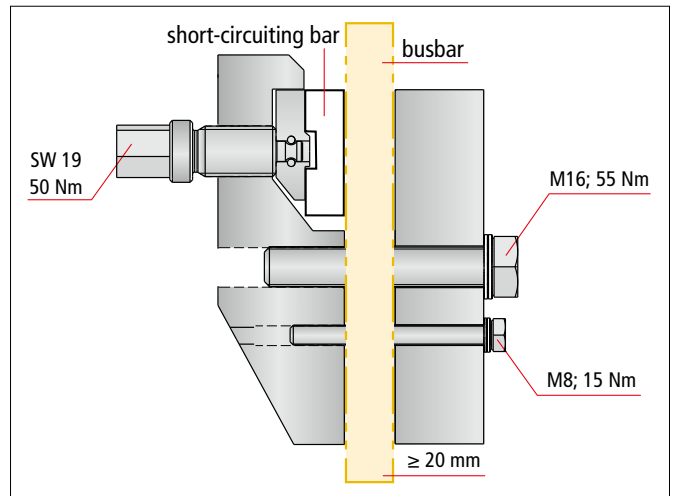

Fixed clamping point mounted on busbar and inserted short-circuiting bar

Short-Circuiting Bar made of Copper

Rigid ball head cap (KKH 20 FS) on the earth cable end.

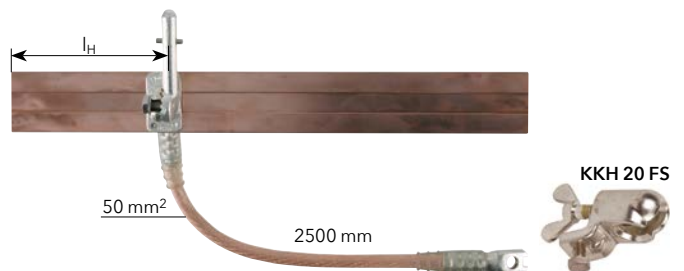

Type	KS SQ C NS VL2FG28	KS SK C NS VHNEFQE
Part No.	VL2FG28	VHNEFQE
Application	LV	LV
Coupling mechanism	SQ	SK
Position of the coupling mechanism (I _H)	175 mm	175 mm
Total length (I _G)	500 mm	500 mm
Bar spacing (S _A)	150 mm	150 mm
Max. short-circuit current I _k 0.5 s	130 kA	130 kA
Max. short-circuit current I _k 1 s	90 kA	90 kA

Type KSX ...	SQ C MS VV7M6CQ	SK C MS V5DHK24
Part No.	VV7M6CQ	V5DHK24
Application	MV	MV
Coupling mechanism	SQ	SK
Position of the coupling mechanism (I _H)	525 mm	525 mm
Total length (I _G)	1500 mm	1500 mm
Bar spacing (S _A)	450 mm	450 mm
Max. short-circuit current I _k 0.5 s	80 kA	80 kA
Max. short-circuit current I _k 1 s	80 kA	80 kA

Short-Circuiting Bar made of Aluminium

Rigid ball head cap (KKH 20 FS) on the earth cable end.

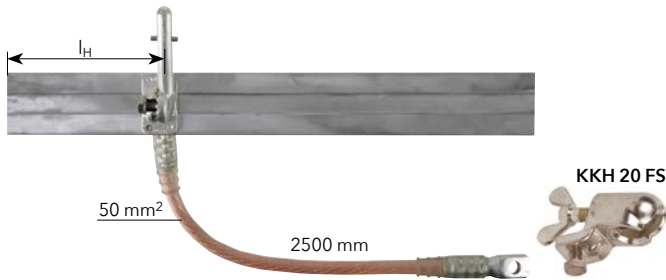

Type	KS SQ A NS VNRLBXU	KS SK A NS VP33XYL
Part No.	VNRLBXU	VP33XYL
Application	LV	LV
Coupling mechanism	SQ	SK
Position of the coupling mechanism (l_H)	175 mm	175 mm
Total length (l_G)	500 mm	500 mm
Bar spacing (S_A)	150 mm	150 mm
Max. short-circuit current I_k 0.5 s	90 kA	90 kA
Max. short-circuit current I_k 1 s	64 kA	64 kA

Type KSX ...	SQ A MS VSJ3Y6N	SK A MS VANH53Y
Part No.	VSJ3Y6N	VANH53Y
Application	MV	MV
Coupling mechanism	SQ	SK
Position of the coupling mechanism (l_H)	675 mm	675 mm
Total length (l_G)	1500 mm	1500 mm
Bar spacing (S_A)	450 mm	450 mm
Max. short-circuit current I_k 0.5 s	60 kA	60 kA
Max. short-circuit current I_k 1 s	60 kA	60 kA

Two coupling mechanisms are required for a total length > 1000 mm.

Note: When ordering, please specify the Variant No. generated online via the earthing and short-circuiting configurator.

Accessories for Short-Circuiting Bar

Clamping point for busbars

Fixed clamping point with fixing elements for a busbar thickness up to 25 mm for short-circuiting bars with longitudinal slot.

*) Note: max values see product data sheet for short-circuiting bar



Type	KLFP M16 KSS
Part No.	795 020
Type	with hexagon shaft wrench size 19
Material	Al / St
Max. short-circuit current I_k 0.5 s	130 kA *)
Max. short-circuit current I_k 1 s	90 kA *)

SQ screw-type adapter

Screw-type adapter with Cardan joint spanner for fitting onto earthing sticks, T pin shaft (bayonet mechanism), for fixed clamping points.



Type	SA KLFP SQ SK
Part No.	795 212
Hexagon socket	wrench size 19 mm

Adapter (T pin shaft / hexagon shaft)

Suitable for putting on earthing sticks with coupling for T pin shaft (bayonet locking mechanism). The lock nut enables the adapter to be fixed to the earthing stick.



Type	AD ES SQ SK
Part No.	765 001
Length	130 mm

EaS Devices (fully insulated) for Low-Voltage Cable Distribution Cabinets



Attaching a fully insulated earthing and short-circuiting device using an earthing handle of type VI.

General technical data:

Standard	EN/IEC 61230 (DIN VDE 0683-100)
Temperature range	-25 °C ... +55 °C

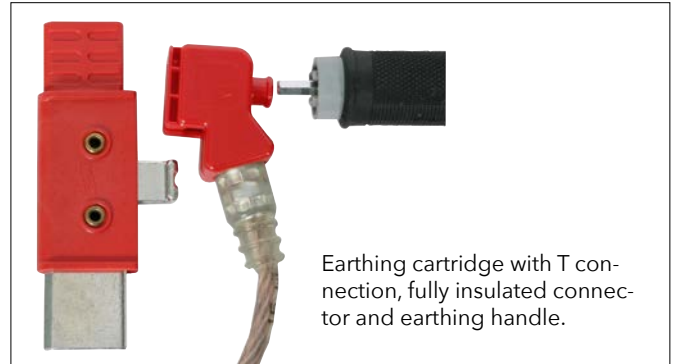

Earthing cartridge with T-connection, fully insulated connector and earthing handle.

Kit for low-voltage installations, fully insulated type VI

- Fully insulated, shock-proof version
- Fully equipped kit for cable distribution cabinets
- Safe operation with insulated earthing handle of type VI (with dual function), suitable for both inserting and removing earthing cartridges with T connection as well as for attaching earthing and short-circuiting devices (EaS devices)
- Waterproof, plastic-sheathed cable entries and node unit, with additional anti-kink protection
- Other cable lengths can be selected online via the earthing and short-circuiting configurator

Kit in Plastic Case



Kit includes:

No.	Part No.
1	745 902 (1x)
3	V162LDM (2x)
4	745 905 (3x)
5	745 910 (6x)
6	745 922 (1x)

For more detailed information on these products, see Single Parts.

Type EKS VI 2F KVS ...	KK
Part No.	745 903
Variant No. of EaS device	V162LDM
Dimensions	450 x 350 x 110 mm

Attention: Please state the relevant Variant No. when ordering.

Kit in Sheet Steel Case



Kit includes:

No.	Part No.
2	745 900 (1x)
3	V162LDM (2x)
4	745 905 (3x)
5	745 910 (6x)
6	745 922 (1x)

For more detailed information on these products, see Single Parts.

Type EKS VI 2F KVS ...	SBK
Part No.	745 901
Variant No. of EaS device	V162LDM
Dimensions	440 x 330 x 100 mm

Attention: Please state the relevant Variant No. when ordering.

Accessories for EaS Devices (fully insulated) for Low-Voltage Cable Distribution Cabinets

Plastic case, empty
With foam padding.



Type	KKL EKS VI KVS
Part No.	745 902
Dimensions	450 x 350 x 110 mm

Sheet steel case, empty
With foam padding.



Type	SBKL EKS VI KVS
Part No.	745 900
Dimensions	440 x 330 x 100 mm

Plastic case, empty
With foam padding and hook-and-loop fastener.



Type	KK 56 41 17 EK VI TI
Part No.	745 952
Dimensions	565 x 410 x 170 mm

EaS device VI, earth clamp with flexible adjustable handle

Adjustable handle with two positions, clamping range up to 20 mm. For cable distribution cabinets.

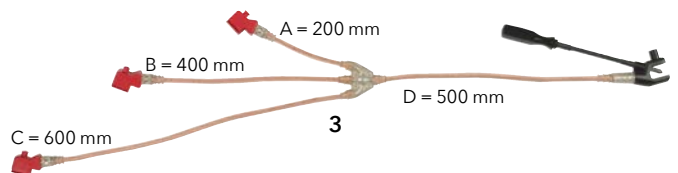

Type EKV3 ...	25VI DG V162LDM	35VI DG VE5K3HM
Part No.	V162LDM	VE5K3HM
Cable cross-section Cu	25/25 mm ²	35/35 mm ²
Max. short-circuit current I _k 0.5 s	7.0 kA	10.0 kA
Max. short-circuit current I _k 1 s	4.9 kA	6.9 kA

Note: When ordering, please specify a clear Variant No.

EaS device VI, spring-loaded earth clamp

Clamping range up to 24 mm, installation via adjustable handle DGF EKV VI.
For cable distribution cabinets.

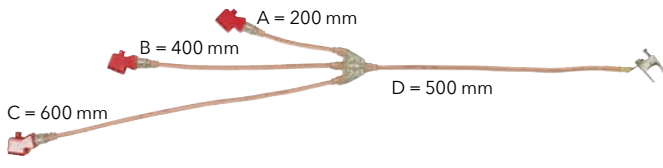

Type EKV3 ...	25VI EK VMRSJWD	35VI EK VEH4JQY
Part No.	VMRSJWD	VEH4JQY
Cable cross-section Cu	25/25 mm ²	35/35 mm ²
Max. short-circuit current I _k 0.5 s	7.0 kA	10.0 kA
Max. short-circuit current I _k 1 s	4.9 kA	6.9 kA

Note: Please state the relevant Variant No. when ordering.

Earthing and short-circuiting device VI, spring-loaded earth clamp

Clamping range up to 24 mm, attachment via adjustable handle DGF EKV VI.
For service entrance boxes.

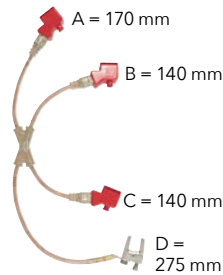

Type EKV3 ...	16VI EK VZPW9LG
Part No.	VZPW9LG
Cable cross-section Cu	16/16 mm ²
Max. short-circuit current I _k 0.5 s	4.5 kA
Max. short-circuit current I _k 1 s	3.2 kA

Note: When ordering, please specify a clear Variant No.

Spring-loaded compact clamp

With T connection and hexagon locking screw (WS 10) for use with earthing handle VI and fixing via adjustable handle with flexible shaft.



Type	KK TA 0 24 SK10
Part No.	745 503
Clamping range	Up to 24 mm
Max. short-circuit current I _k 0.5 s	10.0 kA
Max. short-circuit current I _k 1 s	6.9 kA

Earthing adapter clamp for blade contacts

The earthing adapter clamp is particularly suitable for short-circuiting the LV blade contacts in NH fuse strips having a blade width of 33 or 44 mm and a blade depth of 6 and 8 mm.

With T connection and hexagon locking screw WS10. To be inserted by means of an earthing handle VI and to be fixed by means of an adjustable handle with flexible shaft.



Type	EK SN7089
Part No.	745 510
for blade contact	33 / 44 mm
Max. short-circuit current I _k 0.5 s	10.0 kA
Max. short-circuit current I _k 1 s	6.9 kA

NH 00 earthing cartridges

With T connection for installation into NH fuse holders and blocks of size NH 00 using a VI earthing handle.



Type	EP NH00 VI TA
Part No.	745 905
Size	00
Max. cable cross-section Cu	35 mm ²
Max. short-circuit current I _k 0.5 s	4.9 kA
Max. short-circuit current I _k 1 s	4.9 kA

NH 1 ... 3 earthing cartridges

With T connection for installation into NH fuse holders and blocks of size NH 1 ... 3 using a VI earthing handle.



Type	EP NH1 3 VI TA
Part No.	745 910
Size	1 ... 3
Max. cable cross-section Cu	35 mm ²
Max. short-circuit current I _k 0.5 s	9.6 kA
Max. short-circuit current I _k 1 s	6.9 kA

NH 4a earthing cartridges



Type	EP NH4A VI TA
Part No.	745 915
Size	4a
Max. cable cross-section Cu	35 mm ²
Max. short-circuit current I _k 0.5 s	10.0 kA
Max. short-circuit current I _k 1 s	6.9 kA

VI earthing handle

With dual function

- For installing earthing cartridges with T connection into NH fuse holders
- For connecting VI earthing and short-circuiting devices to earthing cartridges



Type	EG 00 4A VI
Part No.	745 922
Length	285 mm

Rotary handle with flexible shaft

With magnetic socket wrench insert. For connecting spring-loaded earth clamps.



Type	DGF EKV VI
Part No.	745 921
Length	290 mm

EaS Devices (partly insulated) for Low-Voltage Cable Distribution Cabinets



Attaching a partly insulated earthing and short-circuiting device using an earthing handle of type TI.

General technical data:

Standard	EN/IEC 61230 (DIN VDE 0683-100)
Temperature range	-25 °C ... +55 °C



Earthing cartridge with M10 connection, partly insulated connector and earthing handle.

Kit for low-voltage installations, partly insulated type TI

- Fully equipped kit for cable distribution cabinets
- Safe operation with insulated earthing handle of type TI (with dual function), suitable both for installing and removing earthing cartridges with M10 connection as well as for attaching earthing and short-circuiting devices (EaS devices)
- Waterproof, plastic-sheathed cable entries and node unit, with additional anti-kink protection
- Other cable lengths can be selected online via the earthing and short-circuiting configurator

Accessories for EaS Devices (partly insulated) for Low-Voltage Cable Distribution Cabinets

Sheet steel case, empty



Type	SBKL EKS TI KVS
Part No.	766 300
Dimensions	380 x 260 x 80 mm

Kit I in Sheet Steel Case

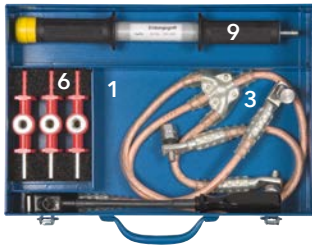

Kit includes:

No.	Part No.
1	766 300 (1x)
3	VSUN6NV (1x)
6	745 018 (3x)
9	745 400 (1x)

For more detailed information on these products, see Single Parts.

Type EKS TI ...	KVS SBK
Part No.	766 302
Variant No. of EaS device	VSUN6NV
Dimensions	380 x 260 x 80 mm

Attention: Please state the relevant Variant No. when ordering.

Sheet steel case, empty

With foam padding.



Type	SBKL EKS TI KVS 2F
Part No.	766 298
Dimensions	440 x 330 x 66 mm

Kit II in Sheet Steel Case

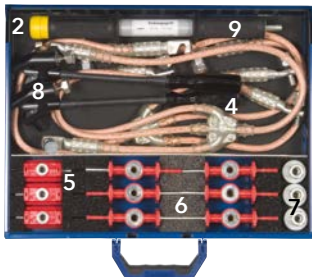

Kit includes:

No.	Part No.
2	766 298 (1x)
4	VUKMT58 (2x)
5	745 302 (3x)
6	745 018 (6x)
7	745 202 (3x)
8	745 602 (2x)
9	745 400 (1x)

For more detailed information on these products, see Single Parts.

Type EKS TI ...	2F KVS SBK
Part No.	745 500
Variant No. of EaS device	VUKMT58
Dimensions	440 x 330 x 66 mm

Attention: Please state the relevant Variant No. when ordering.

Plastic case, empty

With foam padding and hook-and-loop fastener.



Type	KK 56 41 17 EK VI TI
Part No.	745 952
Dimensions	565 x 410 x 170 mm

EaS device TI, earth clamp with flexible adjustable handle

Adjustable handle with two positions, clamping range up to 20 mm. For cable distribution cabinets.

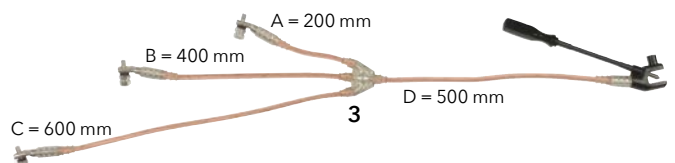

Type EKV3 ...	25TI DG VSUN6NV	35TI DG VSHDQZB
Part No.	VSUN6NV	VSHDQZB
Cable cross-section Cu	25/25 mm ²	35/35 mm ²
Max. short-circuit current I _k 0.5 s	7.0 kA	10.0 kA
Max. short-circuit current I _k 1 s	4.9 kA	6.9 kA

Note: When ordering, please specify a clear Variant No.

EaS device TI, with hook-shaped cable lug on the earth cable end

For installation of earth clamps EK I FL20 DGF or EK FL20 FS.
For cable distribution cabinets.

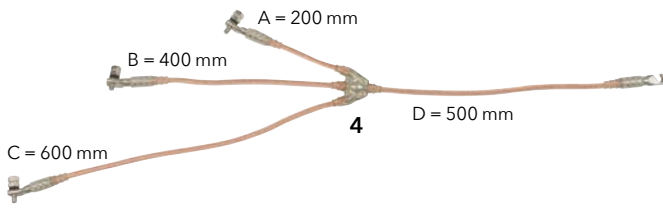

Type EKV3 ...	16TI HK V3RQASE	25TI HK VUKMT58
Part No.	V3RQASE	VUKMT58
Cable cross-section Cu	16/16 mm ²	25/25 mm ²
Max. short-circuit current I _k 0.5 s	4.5 kA	7.0 kA
Max. short-circuit current I _k 1 s	3.2 kA	4.9 kA

Type EKV3 ...	35TI HK VDZ2VDX
Part No.	VDZ2VDX
Cable cross-section Cu	35/35 mm ²
Max. short-circuit current I _k 0.5 s	10.0 kA
Max. short-circuit current I _k 1 s	6.9 kA

Note: When ordering, please specify a clear Variant No.

Earthing and short-circuiting device TI, spring-loaded earth clamp

Clamping range up to 24 mm and fixing via adjustable handle DGF EKV VI.

Earthing cartridges of size 00 fixed on the phase cable end.

For service entrance boxes.

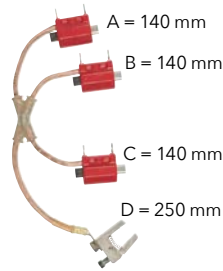

Type	EKV3 NH00 TI V1RC3P2
Part No.	V1RC3P2
Cable cross-section Cu	16/16 mm ²
Max. short-circuit current I _k 0.5 s	4.5 kA
Max. short-circuit current I _k 1 s	3.2 kA

Note: When ordering, please specify a clear Variant No.

Earthing and short-circuiting device TI, spring-loaded earth clamp

Clamping range up to 24 mm and fixing via adjustable handle DGF EKV VI.

Screw-on cable lugs with M10 hexagon pin on the phase cable end.

To be screwed onto earthing cartridges with M10 connection of service entrance boxes.

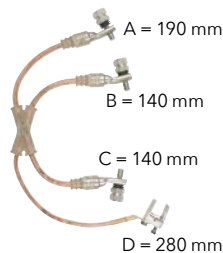

Type	EKV3 16TI EK VSB29AH
Part No.	VSB29AH
Cable cross-section Cu	16/16 mm ²
Max. short-circuit current I _k 0.5 s	4.5 kA
Max. short-circuit current I _k 1 s	3.2 kA

Note: When ordering, please specify a clear Variant No.

NH 00 earthing cartridges

With M10 connection for insertion into NH fuse holders and blocks of size NH 00 using a TI earthing handle.



Type	EP NH00 TI M10
Part No.	745 302
Size	00
Max. cable cross-section Cu	35 mm ²
Max. short-circuit current I _k 0.5 s	4.9 kA
Max. short-circuit current I _k 1 s	4.9 kA

Earthing cartridge NH 00 with grip lugs

With M10 connection for use with earthing handle type TI or NH fuse puller with sleeve NHS AG 00 3 NS.



Type	EP NH00 TI SN7379
Part No.	745 307
Size	00
Max. cable cross-section Cu	35 mm ²
Max. short-circuit current I _k 0.5 s	4.9 kA
Max. short-circuit current I _k 1 s	4.9 kA

NH 1 ... 3 earthing cartridges

With M10 connection for insertion into NH fuse holders and blocks of size NH 1 ... 3 using a TI earthing handle.



Type	EP NH1 3 TI M10
Part No.	745 018
Size	1 ... 3
Max. cable cross-section Cu	35 mm ²
Max. short-circuit current I _k 0.5 s	9.6 kA
Max. short-circuit current I _k 1 s	6.9 kA

NH 1 ... 3 earthing cartridges with grip lugs

With M10 connection for use with TI earthing handle or NH fuse handle with sleeve NHS AG 00 3 NS.



Type	EP NH1 3 TI GL M10
Part No.	745 017
Size	1 ... 3
Max. cable cross-section Cu	35 mm ²
Max. short-circuit current I _k 0.5 s	9.6 kA
Max. short-circuit current I _k 1 s	6.9 kA

NH 4a earthing cartridges

With M10 connection for insertion into NH fuse holders and blocks of size NH 4a.



Type	EP NH4a TI M10
Part No.	745 016
Size	4a
Max. cable cross-section Cu	35 mm ²
Max. short-circuit current I _k 0.5 s	10.0 kA
Max. short-circuit current I _k 1 s	6.9 kA

Adapter

Adapter for earthing cartridges NH 1...3, partly insulated, with M10 connection. For screwing in by means of earthing handle TI through opening (D_{min} = 11 mm) in the window of NH fuse switch disconnectors



Type	AD EP TI M10
Part No.	745 022
Material	Ms/gal CuSn
Thread size	M10
Diameter (bolt)	11 mm
Max. short-circuit current I _k 0.5 s	9.6 kA
Max. short-circuit current I _k 1 s	6.9 kA

Contact blade

With M10 connection for insertion by means of earthing handle type TI.



Type	KM AB M10 SN7280
Part No.	745 021
Size	1 ... 3
Max. cable cross-section Cu	35 mm ²
Max. short-circuit current I _k 0.5 s	9.6 kA
Max. short-circuit current I _k 1 s	6.9 kA

Touch protection for earthing cartridges NH 1...3



Type	BS EP NH1 3 TI
Part No.	745 506
Size	1 ... 3
Material	Thermoplastic

Screw-in earthing insert with M10 connection, insulated

Insulated thread.
To be screwed into E27 and E33 threaded fuse holders using a TI earthing handle.



Type	ESE E27 TI M10	ESE E33 TI M10
Part No.	745 201	745 202
Size	E27	E33
Contact pin	Brass/gal CuSn	Brass/gal CuSn
Thread	Plastic	Plastic
Max. short-circuit current I _k 0.05 s	4.5 kA	7.0 kA

Screw-in earthing insert with M10 connection

Conductive thread.
To be screwed into E27 and E33 threaded fuse holders using a TI earthing handle.



Type	ESE E27 KBI M10	ESE E33 KBI M10
Part No.	745 203	745 204
Size	E27	E33
Contact pin	Plastic	Plastic
Thread	Brass/gal CuSn	Brass/gal CuSn
Max. short-circuit current I _k 0.05 s	4.5 kA	7.0 kA

Earth clamp with flexible adjustable handle and two setting positions

To be connected to the earth cable end of earthing and short-circuiting devices for cable distribution cabinets, with M8 pin with anti-rotation protection and nut.



Type	EK I FL20 DGF
Part No.	745 602
Clamping range	Up to 20 mm

Bare earth clamp with wing bolt

To be connected to the earth cable end of earthing and short-circuiting devices for cable distribution cabinets, with M8 pin with anti-rotation protection and nut.



Type	EK FL20 FS
Part No.	745 502
Clamping range	Up to 20 mm

Spring-loaded compact clamp

With threaded bolt M8 x 12 mm and hexagon locking screw (wrench size 10). Fixed by means of adjustable handle with flexible shaft.



Type	KK M8 0 24 SK 10
Part No.	745 508
Clamping range	Up to 24 mm
Max. short-circuit current I _k 0.5 s	10.0 kA
Max. short-circuit current I _k 1 s	6.9 kA

TI earthing handle

With dual function.

- For installing earthing cartridges or screw-in earthing inserts with M10 connection
- For connecting TI earthing and short-circuiting devices to earthing cartridges (wrench size 19)



Type	EG TI EKV
Part No.	745 400
Length	355 mm

Rotary handle with flexible shaft

With magnetic socket wrench insert. For connecting spring-loaded earth clamps.



Type	DGF EKV VI
Part No.	745 921
Length	290 mm

Earthing and Short-Circuiting Devices for Crane Conductor Bars

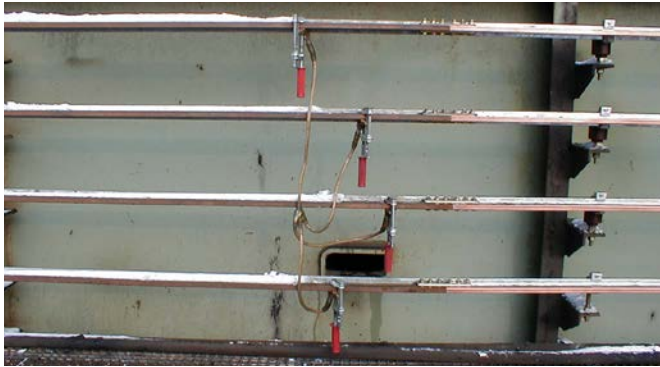

Three-pole earthing and short-circuiting device with screw clamps.

With screw clamps

- For insulated or bare conductor bars of cranes and lifting equipment
- Allows to lock the clamping range of the clamps in several positions
- Waterproof, plastic-sheathed cable entries and node unit, with additional ant-kink protection
- Other cable lengths can be selected online via the earthing and short-circuiting configurator

General technical data:	
Standard	EN/IEC 61230 (DIN VDE 0683-100)
Temperature range	-25 °C ... +55 °C
Material (clamp body)	MCl/gal Zn
Material (pressure plates)	Cu alloy
Material (short-circuiting cables)	Cu, highly flexible

With Screw Clamps for insulated Conductor Bars

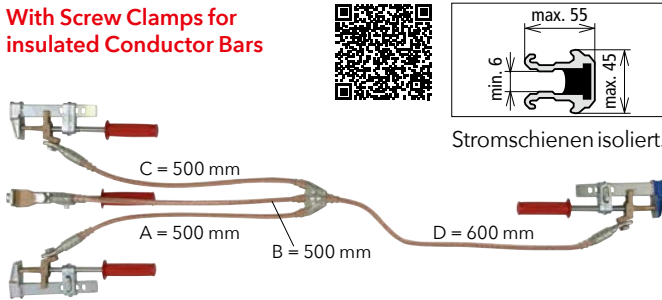

General technical data:	
Clamping range	55 mm
Type EKV3 ...	25IS ZK VH8QTCZ 35IS ZK VKB2Q6J
Part No.	VH8QTCZ VKB2Q6J
Cable cross-section Cu	25/25 mm ² 35/35 mm ²
Max. short-circuit current I _k 0.5 s	7.0 kA 10.0 kA
Max. short-circuit current I _k 1 s	4.9 kA 6.9 kA
Type EKV3 ...	50IS ZK VP6YV4T
Part No.	VP6YV4T
Cable cross-section Cu	50/50 mm ²
Max. short-circuit current I _k 0.5 s	14.0 kA
Max. short-circuit current I _k 1 s	9.9 kA

Attention: Please state the relevant Variant No. when ordering.

With Screw Clamps for bare Conductor Bars

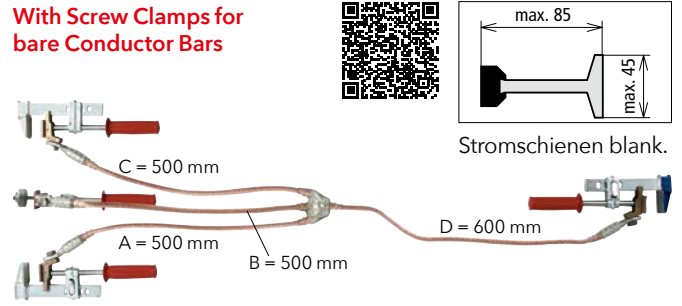

Type EKV3 ...	25BS ZK VQKTK4T	35BS ZK VN63A91
Part No.	VQKTK4T	VN63A91
Clamping range	85 mm	85 mm
Cable cross-section Cu	25/25 mm ²	35/35 mm ²
Max. short-circuit current I _k 0.5 s	7.0 kA	10.0 kA
Max. short-circuit current I _k 1 s	4.9 kA	6.9 kA

Attention: Please state the relevant Variant No. when ordering.

Die Klemme für den PEN-Leiter ist blau gekennzeichnet.

Accessories for Earthing and Short-Circuiting Devices for Crane Conductor Bars

Screw clamps for insulated conductor bars

With M12 bolt.



Type	ZK55 IS	ZK55 IS BL
Part No.	771 230	771 231
Clamping range	55 mm	55 mm
Anti-rotation protection	PK2	PK2
For cable cross-section Cu	25 ... 50 mm ²	25 ... 50 mm ²
Max. short-circuit current I _k 0.5 s	14.0 kA	14.0 kA
Max. short-circuit current I _k 1 s	9.9 kA	9.9 kA

Screw clamps for bare conductor bars

With M12 bolt.



Type	ZK85 BS	ZK85 BS BL
Part No.	771 232	771 233
Clamping range	85 mm	85 mm
Anti-rotation protection	PK2	PK2
For cable cross-section Cu	25 ... 35 mm ²	25 ... 35 mm ²
Max. short-circuit current I _k 0.5 s	10.0 kA	10.0 kA
Max. short-circuit current I _k 1 s	6.9 kA	6.9 kA

Earthing and Short-Circuiting Device for Street Lighting Systems



Earthing and short-circuiting device installed at a junction and fuse box of a street lighting mast.

- For junction and fuse boxes of street lighting systems
- For E14 fuse links
- E27 to E14 thread aluminium adapter
- Max. 125 A backup fuse, operating class: gL/gG

Kit in Plastic Case



Kit includes:

No.	Part No.
1	745 106 (1x)
2	745 107 (2x)
3	745 108 (6x)
4	745 109 (1x)
5	745 921 (1x)

For more detailed information on these products, see Single Parts.

Type	EKV ÜGK MB S
Part No.	745 105
Dimensions	395 x 295 x 105 mm

Accessories for Earthing and Short-Circuiting Device for Street Lighting Systems

Plastic case, empty

With foam padding.



Type	KKL EKV ÜGK MB
Part No.	745 106
Dimensions	395 x 280 x 110 mm
Colour	Grey ●

Earthing and short-circuiting device for street lighting systems

With three fixed E14 screw-in earthing inserts and spring-loaded earth clamp, clamping range up to 24 mm (fixed via rotary handle DGF EKV VI).

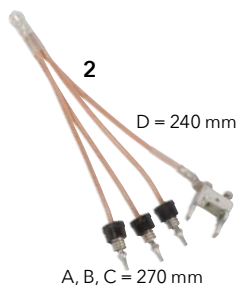

Type	EKV ÜGK MB
Part No.	745 107
Cable cross-section	6 mm ²

Earthing and short-circuiting device for street lighting systems

With two permanently mounted E14 screw-in earthing inserts and two spring-loaded earth clamp, clamping range up to 24 mm (fixing via adjustable handle DGF EKV VI).

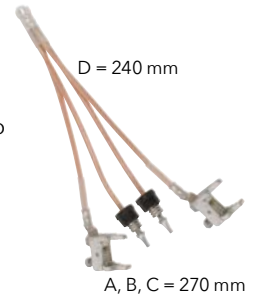

Type	EKV ÜGK MB SN7724
Part No.	745 121
Cable cross-section (phase side)	6 mm ²

Earthing and short-circuiting device for street lighting systems

With three permanently mounted E14 screw-in earthing inserts and spring-loaded earth clamp, clamping range up to 24 mm (fixing via adjustable handle DGF EKV VI).

Type Süwag

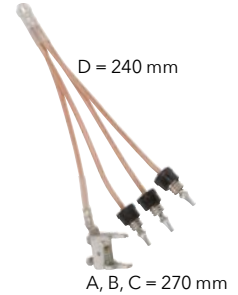

Type	EKV ÜGK MB SN7354
Part No.	745 115
Cable cross-section	6 mm ²
Type	with ratchet screw 4x10 mm

Compact clamp for street lighting

With M8 x 12 mm threaded screw and hexagon locking screw WS10. To be fixed by means of turning handle with flexible shaft.



Type	KKS M8 0 24 SK10
Part No.	745 509
Clamping range	up to 24 mm

E27 / E14 adapter

Reducing insert for converting from E27 to E14 threads.

Allows to use earthing and short-circuiting devices with E14 screw-in earthing inserts even for E27 threads.



Type	REDE E27 E14 ÜGK MB
Part No.	745 108
Dimensions	Ø30 x 25 mm
Material	Al

Installation adapter

For installing E27 / E14 adapters and gauge rings for D-fuses DII and DIII.



Type	PSS DII
Part No.	745 109
Dimensions	Ø30 x 110 mm
Material	Plastic

Rotary handle with flexible shaft

With magnetic socket wrench insert. For connecting spring-loaded earth clamps.



Type	DGF EKV VI
Part No.	745 921
Length	290 mm

Earthing Handle for Low-Voltage Installations



Attaching an earthing and short-circuiting device in a low-voltage switchgear installation using an earthing handle.

For low-voltage installations

- For attaching earthing and short-circuiting devices in low-voltage installations
- End fitting with plug-in coupling for extending the handle
- Light-weight construction
- Hexagon shaft (WS19) or T pin shaft

General technical data:

Standard	T pin shaft DIN 48087
Temperature range	-25 °C ... +55 °C
Material (insulating tube)	Glass-fibre reinforced polyester tube
Material (coupling)	Plastic
Material (end fitting)	Plug-in coupling for extending the handle

Earthing Handle for Hexagon Shafts, Plug-in Coupling

Handle termination with plastic plug-in coupling for extending the handle (spring locking mechanism)



Type EG ...	SK STK 400
Part No.	745 415
Total length (l _G)	400 mm
Length (handle) (l _H)	185 mm

Earthing Handle for T Pin Shafts, Plug-in Coupling

Handle termination with plastic plug-in coupling for extending the handle (bayonet locking mechanism)



Type EG ...	SQ STK 400
Part No.	745 414
Total length (l _G)	400 mm
Length (handle) (l _H)	185 mm

Storage Devices

For easy and safe storage of earthing and short-circuiting devices, voltage detectors and operating sticks (Ø30 or 43 mm).

For a Voltage Detector and an Earthing Stick

For a voltage detector and an earthing stick of any length
Hole spacing: 290/390 mm, holes: Ø7 mm



Type HV ...	P ST D24	P ST D30
Part No.	700 006	700 007
Dimensions	530 x 30 x 136 mm	430 x 30 x 136 mm
For stick diameters	24 mm	30 mm
DB material No.	-	828 077

Type HV ...	P ST D40 45
Part No.	700 008
Dimensions	530 x 30 x 149 mm
For stick diameters	40 ... 45 mm
DB material No.	-

For an Earthing and Short-Circuiting Device and an Earthing Stick

For an earthing and short-circuiting device and an earthing stick of any length
Hole spacing: 424 mm, holes: Ø7 mm



Type HV ...	EKV ES30	EKV ES40
Part No.	700 000	700 002
Dimensions	525 x 175 x 214 mm	525 x 175 x 214 mm
For stick diameters	30 mm	43 mm
DB drawing No.	3 Ebgw 01.70	-
DB material No.	742 395	-

For an Earthing and Short-Circuiting Device and an Earthing Stick up to 1.5 m

For an earthing and short-circuiting device and an earthing stick with a length up to 1.5 m
Hole spacing: 104 mm, holes: Ø7 mm



Type HV ...	EKV ES30 1500
Part No.	700 003
Dimensions	214 x 150 mm
For stick diameters	30 / 43 mm

Sheet Steel Case

Sheet Steel Case for Earthing and Short-Circuiting Device VI/TI

Optionally available with foam padding



General technical data:

Colour Blue ●

Type SBKL EKS ...	VI KVS	TI KVS 2F
Part No.	745 900	766 298
Dimensions	440 x 330 x 100 mm	440 x 330 x 66 mm
Design	With foam padding	With foam padding

Type SBKL EKS ...	TI KVS
Part No.	766 300
Dimensions	380 x 260 x 80 mm
Design	-

Plastic Case

Plastic Case for Earthing and Short-Circuiting Device VI/TI

With foam padding and hook-and-loop fastener.



Type	KK 56 41 17 EK VI TI	KKL EKS VI KVS
Part No.	745 952	745 902
Dimensions	565 x 410 x 170 mm	450 x 350 x 110 mm
Colour	Black ●	Black ●

Plastic Case for Earthing and Short-Circuiting Devices

With retaining springs for two-part earthing stick.



Type	KK 56 41 17 EK HK
Part No.	745 953
Dimensions	565 x 410 x 170 mm
Colour	Black ●

Canvas Bag

Canvas Bag for Earthing and Short-Circuiting Device

With two separate internal pockets and carrier handle.



Type	STT 55 27 30
Part No.	785 111
Dimensions	550 x 255 x 300 mm
Colour	Olive ●
DB drawing No.	3 Ebgw 01.67

MicroΩmeter LoRe EaS

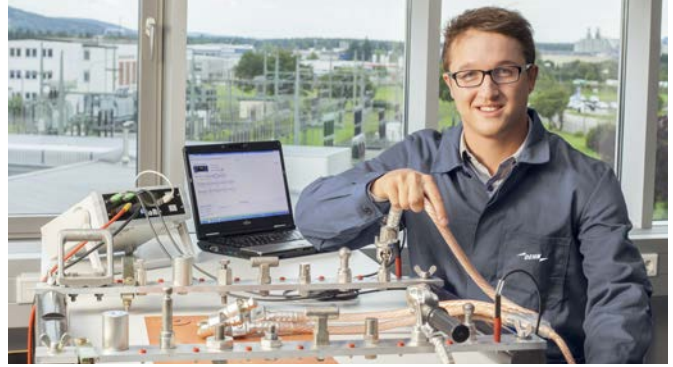

MicroΩmeter LoRe EaS

- Mobile measuring system for performing technical tests on portable earthing and short-circuiting devices (EaS) at regular intervals
- For determining minimum ohmic resistances of earthing and short-circuiting devices and the quality of electrical connections e.g. conductor rails or switch contacts
- Electronic transfer of measured values to the evaluation software via USB interface
- Software-aided procedure and automatic documentation of results
- Acoustic signal as soon as the limit values are exceeded
- Calibrated when delivered
- Software update via USB interface

MikroΩmeter LoRe EaS

Double rail system included in delivery.



Type	MOMS LORE EUK
Part No.	799 100
Measuring range	0.01 μΩ ... 500 mΩ
Min. resolution	1 nΩ
Measuring accuracy	100 nΩ
Type of measurement	Four-conductor measurement
Measuring current	Approx. 30 A ... 70 A
Interface	USB 2.0 connection
Dimensions (case) (H x W x D)	190 x 500 x 450 mm
Weight (with accessories)	Approx. 9 kg
Temperature range	-10 °C ... +40 °C

Insulating Protective Shutters



Inserting a protective shutter of type A4 into a closed system.

According to the five safety rules, adjacent parts are parts situated in the vicinity zone. If parts of an installation near the work location cannot be disconnected, additional safety measures must be taken before starting work as is the case with work in the vicinity of live parts.

Insulating protective shutters according to DIN VDE 0682-522 are used to provide protection against accidental contact with live parts of an installation. They are portable and inserted under live conditions by hand or by using an operating stick. Insulating protective shutters are designed for short-term use in indoor electrical installations according to DIN VDE 0101 with voltages from 1 to 36 kV AC at nominal frequencies below 100 Hz to provide protection against direct contact according to DIN VDE 0105-100 when working in the vicinity of live parts. When used in medium-voltage installations, insulating protective shutters might have to be adapted, for example if it is not possible to insert shutters in the live working zone without risk due to unfavourably located drives, switch components or isolating plates. In such cases, a standard-compliant solution can be found by cutting out parts of the insulating protective shutter or cutting it to size. For that purpose, technical details must be provided. We have developed a special template for insulating protective shutters which can be used, for example, to mark the exact location of cut-outs.

For enquiries and orders, please fill in the template on our website www.dehn-international.com.

Note

Insulating protective shutters do not protect against re-connection. The protected area is the area which is separated from the area containing live parts by the insulating protective shutter. The minimum distances shown in the above table between shutters / shutter edges and live parts must be observed. The protective part (with length l_s and, if required, height h_s) of insulating protective shutters is the part that provides protection against accidental contact with live parts. It is fitted with either a handle or a coupling for attaching an operating stick.

Outside the live working zone, the following gaps are permissible between shutter edge and cell wall:

- Up to 10 mm without restriction
- Up to 40 mm, if the distance between the shutter edge and the live working zone is at least 100 mm
- Up to 100 mm near a switch subconstruction

Rated voltages from 1 to 36 kV

- Protection against accidental contact with live parts of installations with rated voltages from 1 kV to 36 kV
- Four different designs for use in almost all types of switchgear installations



General technical data:

Standard	DIN VDE 0682-522
For	Use in indoor installations only

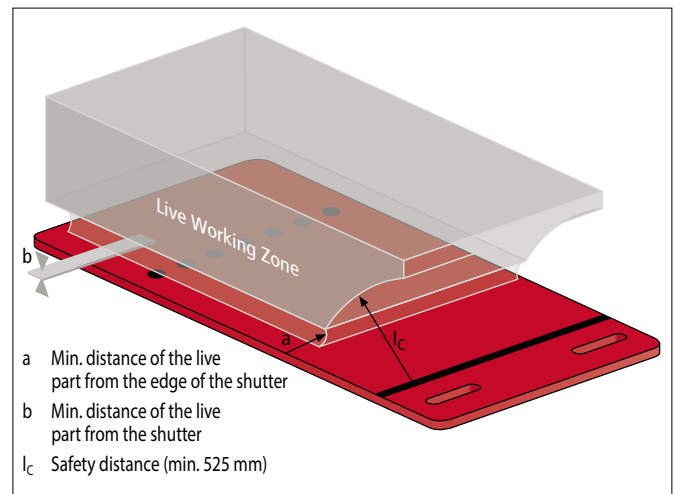

Example of a live working zone in case of an insulating protective shutter of type A1.

Rated voltage	Minimum distance of the live part	
	from shutter edge a	from shutter b
U_r		
3.6 kV	60 mm	0 mm
7.2 kV	90 mm	0 mm
12.0 kV	120 mm	20 mm
24.0 kV	220 mm	60 mm
36.0 kV	320 mm	100 mm

Due to the various designs of switchgear installations, DIN VDE 0682-552 defines four different basic types of protective shutters:

A1, safety distance provides protection during inserting and removing insulating protective shutters.

A2, protective section provides protection during inserting and removing insulating protective shutters.

A3, operating stick provides protection during inserting and removing insulating protective shutters.

A4, protective device installed in the installation provides protection during inserting and removing insulating protective shutters.

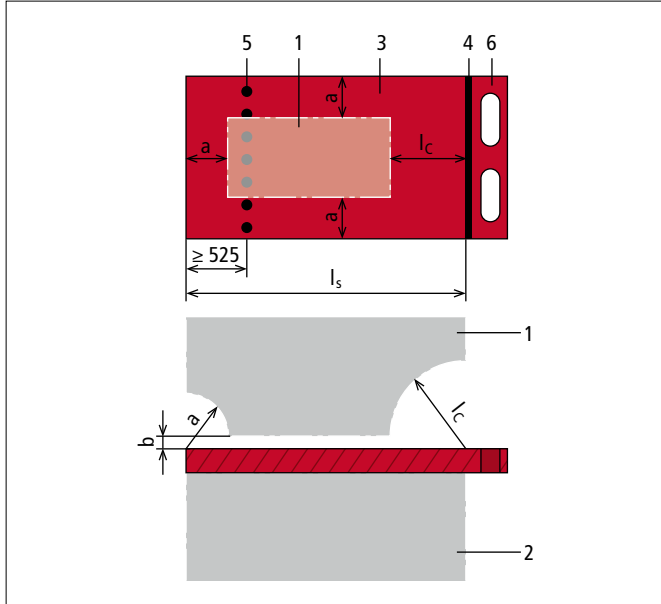

Protective shutter of type **A1** - Operation by hand.

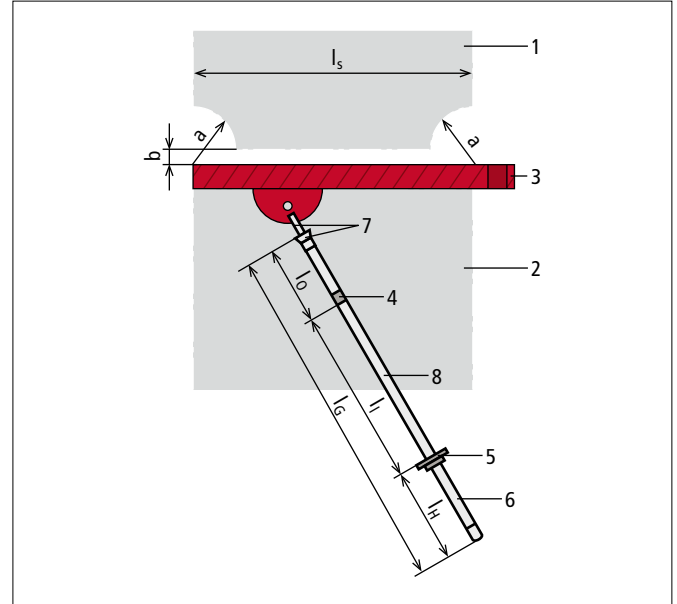

Protective shutter of type **A3** - Operation by means of an operating stick.

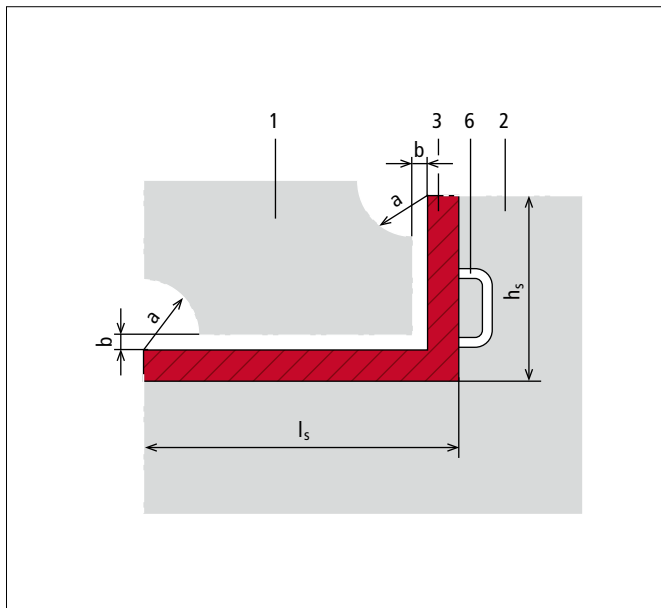

Protective shutter of type **A2** - Operation by hand.

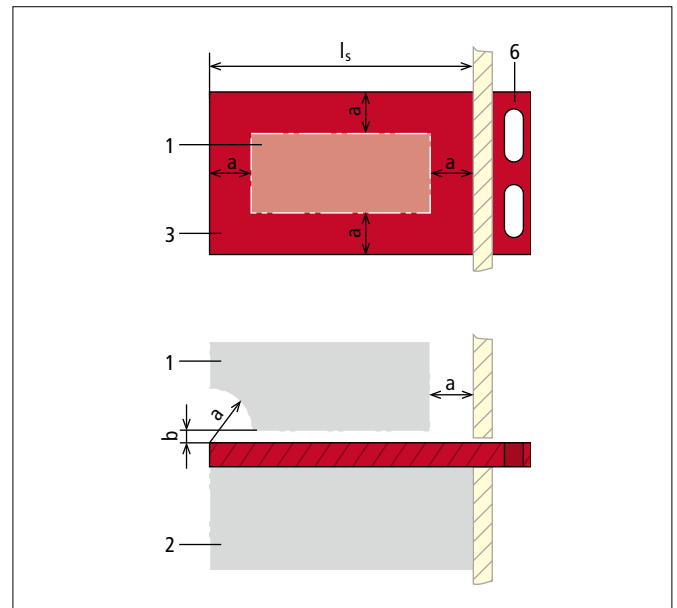

Protective shutter of type **A4** - Operation by hand.

- 1 Live working zone
- 2 Protected area
- 3 Protective section with length l_s (and height h_s)
- 4 Limit mark or red ring
- 5 Guide mark / hand guard
- 6 Handle
- 7 Coupling
- 8 Insulating element of the operating stick with length l_I

- l_0 Total length of the operating stick
- l_H Length of the top section of the operating stick
- l_I Length of the handle of the operating stick
- l_s Length of the insulating element of the operating stick
- l_s Length of the protective section
- l_c Safety distance
- a Minimum distance of live parts from the edge of the insulating protective shutter
- b Minimum distance of live parts from the insulating protective shutter

Type A1

With finger holes, guide and limit mark for inserting and removing insulating protective shutters into / from guide rails by hand.



The guide mark is a dotted line with a minimum distance of 525 mm from the rear shutter edge. The section beyond this mark must not be contacted when inserting the insulating protective shutter. The limit mark is a continuous line and separates the handle from the protective section. The section beyond this mark must not be contacted when inserting the insulating protective shutter and must be at least 525 mm away from live parts when the shutter has been inserted.

Type ISP 36 PVC ...	A1...
Part No.	763 211
Rated voltage (U _r)	Up to 36 kV
Material	Rigid PVC

Type A3

With retaining device with bayonet pin for inserting and removing insulating protective shutters into / from guide rails using an operating stick.



This shutter type is also available with a longitudinal slot and a retaining device (rotatable shutter). In this case, the shutter is operated using an operating stick with switching stick head.

Two persons are required to insert / remove shutter sizes exceeding 1 m². For this purpose, two retaining devices for attaching operating sticks are required. Moreover, insulating protective shutters are also available with rolls.

Type ISP 36 PVC ...	A3...
Part No.	763 231
Rated voltage (U _r)	Up to 36 kV
Material	Rigid PVC

Type A2

With 90° angled handle and hand grips for inserting or removing insulating protective shutters into / from guide rails by hand. Other angled handles (70° to 270°) are available on request.



The height of the handle has to be selected in such a way that live parts of the installation above the shutter are completely covered.

Type ISP 36 PVC ...	A2...
Part No.	763 221
Rated voltage (U _r)	Up to 36 kV
Material	Rigid PVC

Type A4

With finger holes (without additional marks) for use in factory assembled switchgear panels. Instead of finger holes, the shutters are also available with a grip (minimum height: 35 mm).



The shutter is inserted through a slot into the closed installation. The protective device of the installation must ensure full protection when inserting and removing the shutter. In type-tested switchgear installations in accordance with DIN VDE 0670-6 and 7 or EN/IEC 62271-200 (DIN VDE 0671-200), insulating protective shutters may only be used in consultation with the manufacturer of the switchgear installation.

Type ISP 36 PVC ...	A4...
Part No.	763 241
Rated voltage (U _r)	Up to 36 kV
Material	Rigid PVC

Guide rails and other accessories are listed in our template (DEHN Form No. 2090/E).

Insulating mats up to 1,000 V and 36 kV



Switch room with insulating mat fitted.

- For standing surface insulation for live working or in proximity to live installations
- Different lengths

General technical data:

Standard	EN/IEC 61111
----------	--------------

Insulating mat up to 1,000 V



General technical data:

Class	0
Nominal voltage up to (U _N)	1000 V
Temperature resistance	-40°C to +65°C
Width	1000 mm
Thickness	2 mm
Colour	Grey ●

Type ES0FI G - 1 X ...	10	1
Part No.	787 457 <small>NEW</small>	787 461 <small>NEW</small>
Length	10 m	1 m

Type ES0FI G - 1 X ...	2	3
Part No.	787 462 <small>NEW</small>	787 463 <small>NEW</small>
Length	2 m	3 m

Type ES0FI G - 1 X ...	4	5
Part No.	787 464 <small>NEW</small>	787 465 <small>NEW</small>
Length	4 m	5 m

Type ES0FI G - 1 X ...	6	7
Part No.	787 466 <small>NEW</small>	787 467 <small>NEW</small>
Length	6 m	7 m

Type ES0FI G - 1 X ...	8	9
Part No.	787 468 <small>NEW</small>	787 469 <small>NEW</small>
Length	8 m	9 m

Insulating mat up to 36 kV



General technical data:

Class	4
Nominal voltage up to (U _N)	36 kV
Temperature resistance	-40°C to +65°C
Width	1000 mm
Thickness	5.2 mm
Colour	Grey ●

Type ES4FI G - 1 X ...	10	1
Part No.	787 459 <small>NEW</small>	787 471 <small>NEW</small>
Length	10 m	1 m

Type ES4FI G - 1 X ...	2	3
Part No.	787 472 <small>NEW</small>	787 473 <small>NEW</small>
Length	2 m	3 m

Type ES4FI G - 1 X ...	4	5
Part No.	787 474 <small>NEW</small>	787 475 <small>NEW</small>
Length	4 m	5 m

Type ES4FI G - 1 X ...	6	7
Part No.	787 476 <small>NEW</small>	787 477 <small>NEW</small>
Length	6 m	7 m

Type ES4FI G - 1 X ...	8	9
Part No.	787 478 <small>NEW</small>	787 479 <small>NEW</small>
Length	8 m	9 m

Insulating mats with dielectric strength 50 kV



Switch room with insulating mat fitted.

- For use in electrical switch and test rooms
- Not permitted as standing surface insulation for live working!
- Rolled goods or cut to size

Insulating mat with a dielectric strength of 50 kV, rolled goods

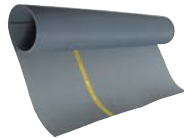

Type IMG SAN 1M ...	10M
Part No.	785 459
Nominal voltage up to (U _N)	50 kV
Material	Polymer NR/SBR
Temperature resistance	-55 °C ... +70 °C
Length	10 m
Width	1000 mm
Thickness	4.5 mm
Colour	Grey ●
Standard	VDE 0303-21

Insulating mat with a dielectric strength of 50 kV, cut to size

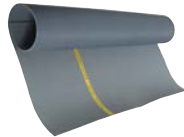

Type IMG SAN 1MM
Part No.	785 458
Nominal voltage up to (U _N)	50 kV
Material	Polymer NR/SBR
Temperature resistance	-55 °C ... +70 °C
Length	up to 10 m *)
Width	1000 mm
Thickness	4.5 mm
Colour	Grey ●
Standard	VDE 0303-21
Minimum order length	1000 mm

*) Length to be specified when ordering!

Note: Can only be supplied in 500 mm increments.

Insulating blankets up to 1,000 V



Covering live parts.

- For protection against accidental and direct contact with live parts
- For covering adjacent live parts
- Different lengths, widths and thicknesses

General technical data:

Standard	DIN VDE 0682-511 (EN/IEC 61112)
----------	---------------------------------

Plastic insulating blanket, rolled goods



Type	ATK 135 50M NS	ATK 120 25M NS
Part No.	785 465	785 467
Class	0	0
Nominal voltage up to (U _N)	1000 V	1000 V
Length	50 m	25 m
Width	1350 mm	1200 mm
Thickness	0.5 mm	1.0 mm
Colour	Crystal clear	Transparent

Plastic insulating blanket, cut to size

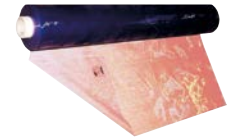

Type	ATK 135 ..M NS	ATK 120 ..M NS
Part No.	785 466	785 468
Class	0	0
Nominal voltage up to (U _N)	1000 V	1000 V
Length	Any up to 50 m *)	Any up to 25 m *)
Width	1350 mm	1200 mm
Thickness	0.5 mm	1.0 mm
Colour	Crystal clear	Transparent
Minimum order length	500 mm	500 mm

*) Length to be specified when ordering!

Note: Can only be supplied in 500 mm increments.

EPDM elastomer wrapping tape, rolled goods

For covering insulators



Type	WBN 200 2,5M NS
Part No.	785 646
Class	0
Nominal voltage up to (U _N)	1000 V
Length	2.5 m
Width	200 mm
Thickness	1.0 mm
Colour	Red ●

DEHNproX - 5. Provide Protection against adjacent Live Parts

EPDM elastomer insulating blanket, rolled goods
With VDE / GS label, flexible at low temperatures.



Type	ATN 140 10M NS
Part No.	785 471
Class	0
Nominal voltage up to (U _N)	1000 V
Length	10 m
Width	1400 mm
Thickness	1.0 mm
Colour	Red ●

Insulating blanket from EPDM elastomer, cut to size



Type	ATN 140 ..M NS
Part No.	785 472
Class	0
Nominal voltage up to (U _N)	1000 V
Length	Any up to 10 m *)
Width	1400 mm
Thickness	1.0 mm
Colour	Red ●
Minimum order length	500 mm

*) Length to be specified when ordering!

Note: Can only be supplied in 500 mm increments.

Accessories for Insulating blankets up to 1,000 V

Clip

With insulated steel spring.



Type	KK 35 NS
Part No.	785 647
Max. clamping range	35 mm
Dimensions	170 / 110 mm
Material	Plastic

Hook



Type	HK 8 NS
Part No.	785 648
Dimensions	Ø8, 126 / 72 mm
Material	Plastic

Eye

Two-piece



Type	OEK 12 NS
Part No.	785 649
Dimensions	Ø12 / 26 mm
Material	Plastic

Insulating caps up to 1,000 V



For insulating bare ends of electrical cables.

- For insulating bare ends of electrical conductors.

Insulating cap with collar



General technical data:

Nominal voltage (U _N)	1000 V
Opening (Ø)	10 mm
Material	Plastic

Type ISK MS QS ...	6 35 L100	10 50 L100
Part No.	700 120 <small>NEW</small>	700 121 <small>NEW</small>
Suitable for	6-35 mm ²	10-50 mm ²
Length	100 mm	100 mm

Type ISK MS QS ...	35 95 L110
Part No.	700 122 <small>NEW</small>
Suitable for	35-95 mm ²
Length	110 mm

Spare Parts

Electric Bulb



Type	GL 3.5V 0.2A E10
Part No.	766 605
Description	Small electric bulb 3.5 V / 0.2 A
Suitable for	PHE

Mignon Battery

Dangerous goods transport regulations only allow delivery of Part No. 766 611 within Germany.



Type	MZ 1.5V L91 FR6 LI 4	MZ 1.5 IEC LR6 AL
Part No.	766 611	766 618
Description	Mignon battery 1.5 V, lithium	Mignon battery 1.5 V, alkaline manganese
PU	4 pieces	1 piece

Block Battery

Dangerous goods transport regulations only allow delivery of Part No. 767 712 within Germany.



Type	EB 9V LI	EB 9V AL
Part No.	767 712	767 713
Description	9 V E block battery, lithium	9 V E block battery, alkaline manganese
PU	1 piece	1 piece

Protective Rubber for PHE



Type	FSG PHE
Part No.	767 776
Suitable for	PHE

Protective Rubber for PHG II



Type	FSG PHG2 PHV
Part No.	767 777
Suitable for	PHG II and PHV

Sealing Ring for PHE III



Type	DR PS PHE3
Part No.	767 779
Suitable for	PHE III test prod and ASP electric field sensor

Sealing Ring for PHE4 and PHV I

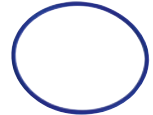

Type	DR PAG
Part No.	759 798
Suitable for	PHE4 and PHV I

Threaded ring for PHE4 and PHV I



Type	GRP PAG
Part No.	759 799
Suitable for	PHE4 and PHV I

Test Prods



Test prod with integrated test electrode allows safe contact with the part of an installation to be tested.

General technical data:

Colour	Grey ● or yellow ●
Diameter	20 mm
Material (test electrode)	Cu alloy/gal Sn
Material (test prod)	Glass-fibre reinforced epoxy resin tube

For PHE III up to 30 kV / Category "S"



Type	S60 PS PHE 285	S61 PS PHE 435
Part No.	767 760	767 761
Total length (l _G)	320 mm	470 mm
Insertion depth (l _O)	285 mm	435 mm

Type	S62 PS PHE 620	S63 PS PHE 780
Part No.	767 762	767 763
Total length (l _G)	655 mm	815 mm
Insertion depth (l _O)	620 mm	780 mm

Type	S64 PS PHE 880
Part No.	767 764
Total length (l _G)	915 mm
Insertion depth (l _O)	880 mm

For PHE III above 30 kV /
Category "S"



Type	S66 PS PHE 880
Part No.	767 771
Total length (l _G)	915 mm
Insertion depth (l _o)	880 mm

For PHE III above 30 kV /
Category "S", CODED



Type S66PS ...	PHE880 C SN771
Part No.	769 701
Total length (l _G)	915 mm
Insertion depth (l _o)	880 mm
Type	Coded

For PHE III up to 30 kV /
Category "L"



Type	L71 PS PHE 185
Part No.	767 766
Total length (l _G)	220 mm
Insertion depth (l _o)	185 mm

For Siemens 8CK Switchgear
Installations

Category "S" for voltage detector PHE III Part No. 767 721, 767 951, 767 722, 767 740 and 767 940.



Type	S63 PS PHE 8CK
Part No.	767 768
Total length (l _G)	880 mm
Insertion depth (l _o)	845 mm

Other versions are available on request.

Operating Heads

STK switching stick head



Type	SSK 36 STK 560	SSK 36 STK 930SN7689
Part No.	766 164	766 169
Total length (l _G)	560 mm	930 mm

Screw-on switching stick head for
IS SK insulating sticks

With M12 thread.
In accordance with DIN VDE V 0681-2.



Type	SSK M12
Part No.	765 005
Material	Steel, plastic-sheathed

Switching stick head for
IS SQ insulating sticks

With T pin shaft (bayonet locking mechanism).
In accordance with DIN VDE V 0681-2.
T pin shaft in accordance with DIN 48087.
Switching stick head is fixed on the insulating stick via the knurled nut.



Type	SSK SQ
Part No.	765 009
Material	Polyamide

STK operating head / T pin shaft

Operating head with spring-loaded bayonet coupling for indoor use.



Type	AK 36 SQ STK 360
Part No.	766 365
Total length (l _G)	360 mm

STK operating head / hexagon shaft

Operating head with tension spring locking and M12 threaded bushing for indoor use.



Type	AK 36 SK STK 330
Part No.	766 364
Total length (l _G)	330 mm

Insulating Sticks

Insulating stick for PHE4 with M12 threaded bushing



General technical data:	
Material	Glass-fibre reinforced polyester tube

Type	IS PHE4 STK 700	IS PHE4 STK 770
Part No.	783 900	783 905
Total length (l _G)	700 mm	770 mm
Length (handle) (l _H)	250 mm	220 mm

Type	IS PHE4 STK 1110
Part No.	783 906
Total length (l _G)	1110 mm
Length (handle) (l _H)	520 mm

Insulating stick for PHE III with M12 threaded bushing

With plug-in coupling for extending the handle.



Type	IS M12 STK 640
Part No.	766 331
Total length (l _G)	640 mm
Length (handle) (l _H)	270 mm
Material	Glass-fibre reinforced polyester tube

Insulating stick for PHE III with M12 threaded bushing

With end cap.



Type	IS M12 AK 635
Part No.	766 328
Total length (l _G)	635 mm
Handle length (l _H)	270 mm
Material	Glass-fibre reinforced polyester tube

Insulating stick for PHE4 and PHE III with universal gear coupling

Handle end fitting with plastic plug-in coupling as extension handle.



Type	IS ZK STK 670
Part No.	766 368
Total length (l _G)	670 mm
Length (handle) (l _H)	265 mm
Material	Glass-fibre reinforced polyester tube

Insulating stick for ASP with universal gear coupling

Plug-in coupling for extending the handle.



Type	IS ZK STK HS 670
Part No.	766 369
Total length (l _G)	670 mm
Length (handle) (l _H)	270 mm
Material	Glass-fibre reinforced polyester tube

IS STK insulating stick with plug-in coupling

Plug-in coupling at both ends for attaching extension elements, operating heads or adapters.



Type	IS 36 STK 30 1280	
Part No.	766 363	
Nominal voltage (U _N)	Up to 36 kV	
Total length (l _G)	1280 mm	
Length (handle) (l _H)	560 mm	

ISN 36 STK insulating stick with silicon insulator

Plug-in coupling at both ends for attaching extension elements, operating heads or adapters.



Type	ISN 36 STK 30 1280	ISN 36 STK 930SN7688
Part No.	766 367	766 362
Nominal voltage (U _N)	Up to 36 kV	Up to 36 kV
Total length (l _G)	1280 mm	930 mm
Length (handle) (l _H)	560 mm	190 mm
Material	Glass-fibre reinforced polyester tube	Glass-fibre reinforced polyester tube

Telescopic insulating stick, with universal gear coupling

With scale for measuring the ground clearance, mounted support included.



Type	ISMTC N 36 ZK 10600	
Part No.	766 037	
Nominal voltage (U _N)	Up to 36 kV	
Total length (l _{G max} / l _{G min})	10,600 / 1750 mm	
Length (handle) (l _{H min})	1680 mm	
Material	Glass-fibre reinforced epoxy resin tube	

Accessories for Insulating Sticks ISMTC

Contacting aid

For telescopic insulating sticks.



Type	AK AH ZK ISMTC
Part No.	766 049
Total length (l _G)	340 mm

Support



Type	AH ISMTC
Part No.	766 038
Suitable for	Telescopic insulating stick

Plastic bolt with star knob



Type	KS SG BLS 8
Part No.	766 105
Suitable for	Universal gear coupling

Canvas bag, empty - With carrier handle

Max. capacity:

- 1 Telescopic insulating stick
- 1 Contacting aid
- 1 Test prod



Type	STT 180 20
Part No.	766 039

DEHNproX - Safe working on electrical installations / Live working

Insulating Elements

Insulating element with M12 threaded bushing

With plug-in coupling for the handle.



Type	IT M12 STK 30 1150	ISO M12 STK 30SN7563
Part No.	766 115	766 116
Nominal voltage (U _N)	up to 110 kV	up to 110 kV
Total length (l _G)	1150 mm	780 mm
Type	-	coded

Insulating element with hand guard



Type	ISU STK STK 30SN7564
Part No.	766 117
Nominal voltage	up to 110 kV
Total length (l _G)	935 mm
Type	coded

Insulating element with gear coupling

With plug-in coupling.

Setting angle of the gear coupling: - 30° / 0° / + 30°.



Type	IT ZK30 STK 30 360
Part No.	766 358
Total length (l _G)	360 mm

Insulating element for PHE4



Type	IT PHE4 STK 760	IT PHE4 STK 1210
Part No.	783 920	783 925
Total length (l _G)	760 mm	1210 mm

Adapter

Adapter with M12 threaded bushing

With plug-in coupling.



Type	AD M12 STK 30 350	AD PHE4 STK 410
Part No.	766 352	783 930
Total length (l _G)	350 mm	410 mm

Adapter with gear coupling

With plug-in coupling.



Type	AD ZK STK 30 360
Part No.	766 359
Total length (l _G)	360 mm

Adapter with cone-shaped support

With gear coupling and cone-shaped support, accommodates cleaning sponges (Part No. 766 056).



Type	AD ZK 25 200
Part No.	766 055
Total length (l _G)	200 mm

Handle / Extensions

Handle

With hand guard and end fitting with plug-in coupling for extending the handle.



Type	H STK 43 800
Part No.	766 120
Total length (l _G)	830 mm

Handle

With hand guard and end fitting with plug-in coupling for extending the handle.



Type	H STK 43 500
Part No.	766 520
Total length (l _G)	500 mm

Insulating Stick Extension for PHE4

For nominal voltage range 110 ... 220 kV and 220 ... 420 kV.



Type	ISV PHE4 43 1100
Part No.	783 945
Total length (l _G)	1100 mm

ISV 36 STK insulating stick extension

Plug-in coupling at both ends for extending the insertion depth or the handle.



Type	ISV 36 STK 30 910	ISV 36 STK 30 1280
Part No.	766 356	766 366
Total length (l _G)	910 mm	1280 mm

HV STK extension handle







Plug-in coupling at both ends for extending the handle.



Type	HV STK 30 710	HV STK 43 910
Part No.	766 335	766 456
Total length (l _G)	710 mm	910 mm
Diameter	30 mm	43 mm

Type	HV STK 43 1280	HV STK 43 975
Part No.	766 466	766 077
Total length (l _G)	1280 mm	975 mm
Diameter	43 mm	43 mm

Type	HV STK 43 1045	HV STK 43 2350
Part No.	766 076	766 073
Total length (l _G)	1045 mm	2350 mm
Diameter	43 mm	43 mm

Type / Application	Nominal voltage U_N / Frequency f_N	Product	Page
<p>TRS NS dry cleaning kit</p> <ul style="list-style-type: none"> ▪ Suction cleaning under live conditions ▪ Specially adapted operating heads for intensive cleaning ▪ Plug-in coupling system for quick exchange of operating heads 	up to 1,000 V / 15 ... 60 Hz		105
<p>FRS ZK MS damp cleaning kit</p> <ul style="list-style-type: none"> ▪ Damp cleaning equipment for use under live conditions with special cleaning liquid ▪ Universal gear coupling for replacing and adjusting the angle of operating heads ▪ Plug-in operating heads allow fast and easy replacement of the sponges 	up to 36 kV / 15 ... 60 Hz		105
<p>TRS MS / TRS MS V1 dry cleaning kits</p> <ul style="list-style-type: none"> ▪ Suction cleaning under live conditions ▪ Transparent intake tubes for enhanced safety ▪ Specially adapted operating heads for intensive cleaning ▪ Plug-in coupling system for quick exchange of operating heads 	up to 36 kV / 15 ... 60 Hz		106
<p>TFRS MS combined cleaning kit</p> <ul style="list-style-type: none"> ▪ Combined dry and damp cleaning ▪ Transparent intake tubes for enhanced safety ▪ Specially adapted operating heads for intensive cleaning ▪ Universal gear coupling for replacing and adjusting the angle of operating heads ▪ Plug-in operating heads allow fast and easy replacement of the sponges 	up to 36 kV / 15 ... 60 Hz		107
<p>Hand oiler for switchgear installations</p> <ul style="list-style-type: none"> ▪ For lubricating movable parts in switchgear installations. ▪ Transparent insulating hand oiler ensures increased safety ▪ Easy to use thanks to flexible tip ▪ If required, the insertion depth of the hand oiler can be increased by means of optional extensions 	up to 36 kV / 50 Hz		109
<p>Maintenance test according to German Social Accident Insurance (DGUV) Regulation 3 (formerly accident prevention regulations BGV A3)</p> <p>Operating sticks also have to be subjected to electrotechnical tests. Therefore we recommend testing according to German Social Accident Insurance (DGUV) Regulation 3 (formerly accident prevention regulations BGV A3) This entails testing for compliance with the limit values specified in the electrotechnical rules. The test includes:</p> <ul style="list-style-type: none"> ▪ Testing the discharge current ▪ Testing the protection against bridging ▪ Visual inspection <p>The maintenance test is documented in a test report and on the device itself.</p> <p>The intervals for maintenance tests depend on the conditions of use, e.g. frequency of use, stress due to environmental conditions and transport, etc, however, according to DGUV regulation 3, at least every 6 years.</p>			7



Permanent availability of electricity has become a decisive factor in international competition.

At the same time, increasing cost pressure in the energy supply sector means that less and less redundancy is being made available in the power supply. First of all, this requires increased operational reliability of existing plants, and secondly, it is not always possible to disconnect entire plant sections for the necessary maintenance and servicing work. Live working offers an alternative. DEHN has experience in this method of working and has developed products that can be found in the DELTEC product range.

Disconnecting installations for maintenance work

Electrical equipment and low, medium and high-voltage systems such as overhead lines, transformer substations, switchgear installations, distribution boards, transformer cells or cable distribution cabinets cannot be disconnected or can only be disconnected with great effort due to undesired downtimes or cost-intensive work on Sundays and public holidays.

Live cleaning

Clean installations increase system reliability

In case of adverse weather conditions (moisture), arc exposure may occur as a result of soiled installations, dust layers and residue from lubricants on insulators and cable sealing ends in medium-voltage installations, cobwebs and weeds in cable distribution boards as well as dust and lubricant layers in low-voltage installations, resulting in power failure, damage to the equipment and even injury or death.

Regular cleaning intervals

Surveys have shown that, depending on the type and degree of soiling, cleaning work on open indoor systems and cable distribution cabinets is required at regular intervals of between roughly six months and two years.

Dry cleaning by suction combined with damp cleaning

Dry cleaning work is performed by suction with operating heads or by brushing soiled parts of the installation while simultaneously sucking the dirt away. Loose dust layers and cobwebs are quickly and easily vacuumed away. In the case of oily and stubborn deposits, wet cleaning with sponges moistened with special insulating cleaning fluid has the desired cleaning effect. The work is carried out according to the live working procedure "hot stick working".

Dry suction cleaning equipment

Suction cleaning equipment consists of a cleaning head (operating heads, brushes), intake tube with handle, extension, intake hose and suction device.

All individual parts are made of plastic and are fully insulated.

The shape of the brushes and operating heads is largely adapted to the parts of installations to be cleaned.

The special plug-in coupling system of the dry cleaning equipment prevents accidental use of accessories not intended for this application (e.g. industrial vacuum cleaner accessories).

Requirements on the suction device

The suction device used must meet the following requirements:

- The industrial suction cleaner must have a minimum air velocity of 20 m/s and a visual indication of the intake capacity.
- The intake hose must have a continuous inner diameter ≥ 30 mm and be free of metal parts.

Damp cleaning equipment

Damp cleaning equipment consists of special cleaning heads (sponge holders), an insulating stick with handle and extension elements. All individual parts are fully insulated. The plug-in system of operating heads and sponges allows easy and fast replacement of dirty sponges. Only approved sponges may be used for this purpose.

Requirements on installers

Selection of electrically skilled persons for live working

Maintenance and repair work may only be carried out by electrically skilled persons with several years of experience in operating or maintaining electrical installations who have also successfully completed a special training course for such work.

During this training, both basic theoretical knowledge and practical skills (training of individual work processes) are taught.

Training as live worker

The training as a specialised live worker is based on detailed target descriptions as required by the German trade association BG ETEM "Live working on electrical installations and equipment", DGUV regulation 103-011 (previously BGR A3). It includes theoretical and practical training for the electrically skilled person and ends after a performance test with the presentation of a "live working" certificate.

"Live working" procedure

During hot stick working, the worker keeps a predefined distance from live parts of the installation and uses insulating sticks/operating sticks.

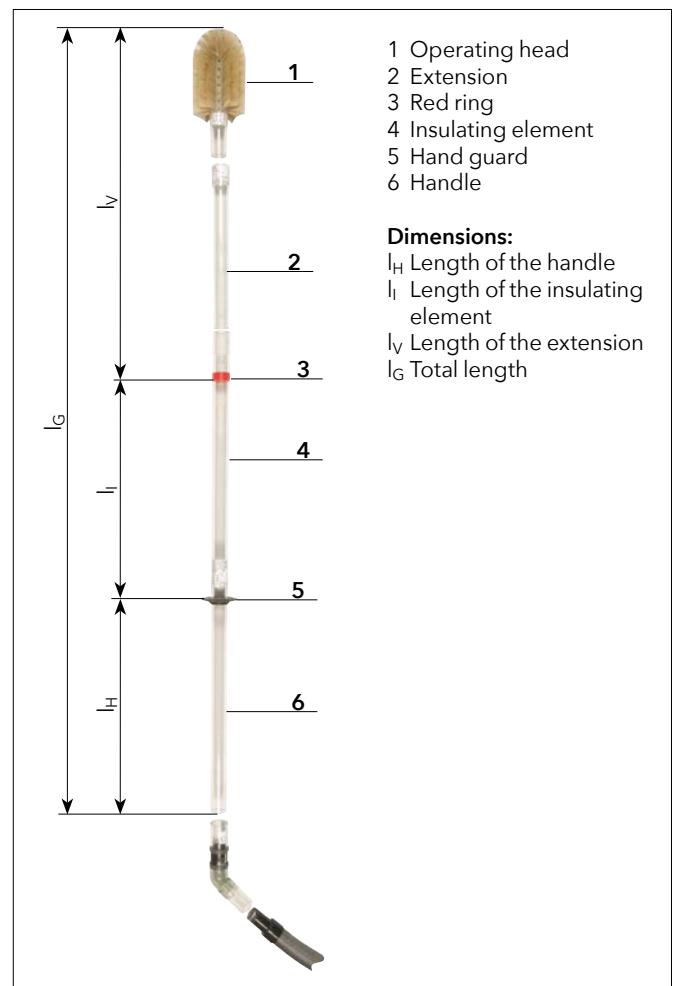

Schematic diagram

TRS NS Dry Cleaning Kit

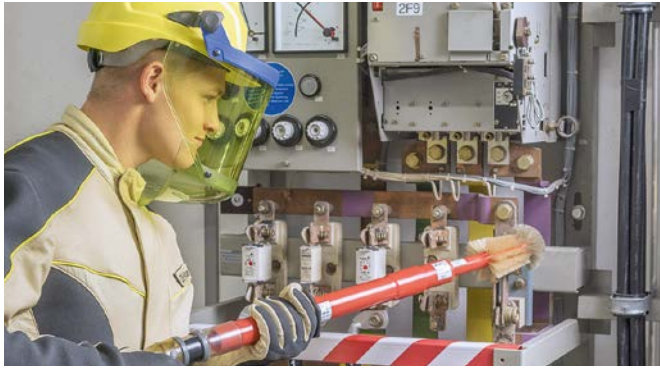

Live cleaning of a low-voltage switchgear installation using the TRS NS dry cleaning kit.

Nominal voltages up to 1000 V / 15 ... 60 Hz

- For indoor and outdoor installations
- Equipment for suction cleaning under live conditions
- For dry cleaning of cable distribution cabinets, open indoor installations and control cabinets
- Specially adapted operating heads for intensive cleaning
- Plug-in coupling system allows fast replacement of operating heads
- Regulation of intake air in the handle area



General technical data:

Standard	Based on DIN VDE 0682-621
Not for use in wet weather conditions	☀

Requirements

Cleaning work up to 1000 V generally is allowed to be done under supervision of a qualified electrician according to EN 50110-1 "Operation of electrical installations" and is allowed to be done in accordance with the national accident prevention regulations (UVV) "Elektrische Anlagen und Betriebsmittel" [Electrical installations and equipment] stipulated by the German Employer's Liability Association for the energy, textile, electrical and media product sector (BG ETEM) under observation of DGUV regulation 3 (previously BGV A3).



TRS NS Dry Cleaning Kit
Fully equipped plastic case.



Kit includes:

No.	Part No.	No.	Part No.
1	785 506	12	785 560
2	785 520	13	785 543
3	785 521	14	785 570
4	785 522	15	785 550
5	785 523	16	785 555
6	785 530	17	785 515
7	785 540	18	785 200
8	785 541	19	785 595
9	785 542	20	785 596
10	785 590	21	785 580
11	785 591	22	785 585

For more detailed information on these products, see www.dehn-international.com.

Type	TRS NS
Part No.	785 502
Dimensions	560 x 410 x 170 mm
Total length (l _{G max} / l _{G min})	1350 / 560 mm

FRS ZK MS Damp Cleaning Kit



Damp cleaning of a transformer using the FRS ZK MS damp cleaning kit.

Nominal voltages up to 36 kV / 15 ... 60 Hz

- For indoor and outdoor installations
- Damp cleaning equipment for use under live conditions with special cleaning liquid
- Universal gear coupling for replacing and adjusting the angle of operating heads
- Rigid and flexible plug-in operating heads allow fast and easy replacement of the sponges



General technical data:

Standard	Based on DIN VDE 0681-1 and DIN VDE 0682-621
Standard (universal gear coupling)	EN/IEC 60832 (DIN VDE 0682-211)
Not for use in wet weather conditions	☀

Application

Damp sponges allow to remove tough pollution layers and to clean oily transformer surfaces. Special insulating cleaning liquids (e.g. Rivolta SLX 500; SLX TOP or SLX Super from Bremer & Leguil, Duisburg/Germany, and Florin 2000 from Flore, Koblenz/Germany) must be selected according to the rated voltage of the installation and the environmental conditions.

Requirements

Cleaning work from 1 to 36 kV must be carried out under supervision of a qualified electrician according to EN 50110-1 "Operation of electrical installations - Minimum Requirements", observing clauses 6.3.1 to 6.3.12. In Germany FRS ZK MS damp cleaning kits are subject to DGUV Vorschrift 3 (former BGV A3) and DGUV Regel 103-011 (former BGR A3) of the national accident prevention regulations (UVV) "Elektrische Anlagen und Betriebsmittel" [Electrical installations and equipment] stipulated by the German Employer's Liability Association for the energy, textile, electrical and media product sector (BG ETEM).



FRS ZK MS Damp Cleaning Kit
Fully equipped GRP case.



Kit includes:

No.	Part No.	No.	Part No.
2	785 229	32	785 324
8	785 315	33	785 322
11	785 316	34	785 323
12	785 317	35	785 274
13	785 318	36	785 275
14	785 319	37	785 279
30	785 320	38	785 280
31	785 321		

For more detailed information on these products, see www.dehn-international.com.

Type	FRS ZK MS
Part No.	785 940
Dimensions	945 x 285 x 170 mm
Total length (l _{G max} / l _{G min})	3250 / 1450 mm
Extension (l _{G max} / l _{G min})	2100 / 350 mm

TRS MS Dry Cleaning Kit



Live cleaning of a transformer using the TRS MS dry cleaning kit.

General technical data:

Standard	DIN VDE 0682-621
Not for use in wet weather conditions	☀

Requirements

Cleaning work from 1 to 36 kV must be carried out under supervision of a qualified electrician according to EN 50110-1 "Operation of electrical installations - Minimum Requirements", observing clauses 6.3.1 to 6.3.12. In Germany TRS MS dry cleaning kits are subject to DGUV Vorschrift 3 (previously BGV A3) and DGUV Regel 103-011 (previously BGR A3) of the national accident prevention regulations (UVV) "Elektrische Anlagen und Betriebsmittel" [Electrical installations and equipment] stipulated by the German Employer's Liability Association for the Energy, Textiles, Electric and Media Industry (BG ETEM).

Nominal voltages up to 36 kV / 15 ... 60 Hz

- For indoor and outdoor installations
- Equipment for live cleaning by means of suction
- For dry cleaning of transformers and switchgear installations
- Transparent intake tubes ensure enhanced safety
- Specially adapted operating heads for intensive cleaning
- Plug-in coupling system allows fast replacement of operating heads



TRS MS Dry Cleaning Kit

Fully equipped GRP case.



Kit includes:

No.	Part No.	No.	Part No.
1	785 301	19	785 140
5	785 131	20	785 150
6	785 132	21	785 170
7	785 130	25	785 220
10	785 120	26	785 221
15	785 121 ^{*)}	39	785 200
16	785 122 ^{*)}	42	785 180
17	785 123 ^{*)}	44	785 190
18	785 160	47	785 210

^{*)} 2 pieces in a set

For more detailed information on these products, see www.dehn-international.com.



TRS MS V1 Dry Cleaning Kit

Fully equipped GRP case.



Kit includes:

No.	Part No.	No.	Part No.
1	785 301	21	785 170
5	785 131	22	785 171
6	785 132	23	785 172
7	785 130	25	785 220
10	785 120	26	785 221
15	785 121 ^{*)}	39	785 200
16	785 122 ^{*)}	40	785 212
17	785 123	42	785 180
18	785 160	44	785 190
19	785 140	47	785 210

^{*)} 2 pieces in a set

For more detailed information on these products, see www.dehn-international.com.



Type TRS ...	MS
Part No.	785 100
Dimensions	1260 x 305 x 205 mm
Total length (l _{G max} / l _{G min})	3580 / 1180 mm
Extension (l _{G max} / l _{G min})	2515 / 115 mm

Type TRS ...	MS V1
Part No.	785 112
Dimensions	1260 x 305 x 205 mm
Total length (l _{G max} / l _{G min})	3580 / 1180 mm
Extension (l _{G max} / l _{G min})	2515 / 115 mm

TFRS MS Combined Cleaning Kit

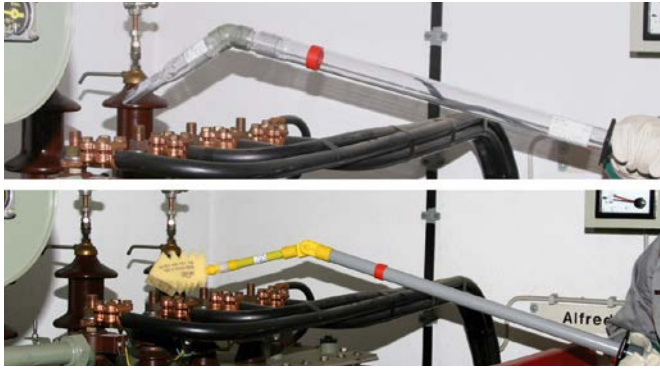

TFRS MS combined cleaning kit used for dry and damp cleaning of a transformer under live conditions.

Nominal voltages up to 36 kV / 15 ... 60 Hz

- For indoor and outdoor installations
- Combined dry and damp cleaning kit for cleaning under live conditions
- Transparent intake tubes ensure enhanced safety
- Specially adapted operating heads for intensive cleaning
- Universal gear coupling for replacing and adjusting the angle of operating heads
- Rigid and flexible plug-in operating heads allow fast and easy replacement of the sponges



TFRS MS Combined Cleaning Kit

Fully equipped GRP case and leather bag.



Type	TFRS MS
Part No.	785 950
Dimensions (bag)	1400 x 280 mm
Dimensions (case)	900 x 415 x 430 mm

General technical data:

Standard	Based on DIN VDE 0681-1 and DIN VDE 0682-621
Standard (universal gear coupling)	EN/IEC 60832 (DIN VDE 0682-211)
Not for use in wet weather conditions	☀

Application

Dry cleaning work is performed by suction cleaning with operating heads or brushing soiled parts of the installation while simultaneously sucking the dirt away. Loose dust layers and cobwebs are easily removed with little effort. Damp cleaning eliminates oily and tough contaminants with the help of sponges soaked with special insulating cleaning liquids.

Requirements

Cleaning work from 1 to 36 kV must be carried out under supervision of a qualified electrician according to EN 50110-1 "Operation of electrical installations - Minimum Requirements", observing clauses 6.3.1 to 6.3.12. In Germany TFRS MS combined cleaning kit are subject to DGUV Vorschrift 3 and DGUV Regel 103-011 (previously BGV A3 and BGR A3) of the national accident prevention regulations (UVV) "Elektrische Anlagen und Betriebsmittel" [Electrical installations and equipment] stipulated by the German Employer's Liability Association for the Energy, Textiles, Electric and Media Industry (BG ETEM).



Kit includes - Case:

No.	Part No.	No.	Part No.
3	785 951	27	785 223
5	785 131	28	785 551
6	785 132	29	785 552
7	785 130	30	785 320
11	785 316	31	785 321
12	785 317	32	785 324
13	785 318	33	785 322
14	785 319(2)	34	785 323
15	785 121	35	785 274
16	785 122	36	785 275
17	785 123(2)	37	785 279
18	785 160	38	785 280
19	785 140	39	785 200
20	785 150	40	785 212
21	785 170	41	785 259
22	785 171	43	785 181
23	785 172	44	785 190
24	785 151	45	785 953
25	785 220	46	785 224
26	785 221		

Kit includes - Bag:

No.	Part No.	No.	Part No.
4	785 952	47	785 210
9	785 325	48	785 585
10	785 120	49	785 109

For more detailed information on these products, see www.dehn-international.com.

Accessory for NS and MS Cleaning Kits

Industrial vacuum cleaner

For dry and combined cleaning kits.



Equipment:

25 l special plastic container, 2 large wheels, 2 guide wheels with locking brakes, handle and cable holder, socket outlet with automatic switch-on mechanism, electromagnetic pulse filter cleaning, automatic vibration function, speed control, volume flow control, acceleration rate controller, electronic running feature, moisture identification with sensor-controlled disconnection, 2 new polyester filter cassettes, FKP 4300, filter area 2x 4300 cm² = 8600 cm², dust collection capacity 99,99 %, class L in accordance with DIN EN 60335-2-69 Annex AA, cord length 8 m.

Technical data:

Intake hose with straight connecting adapter Ø35 mm, 5 m long

Type	HISC 1600
Part No.	785 310
Dimensions	450 x 390 x 490 mm

Application:

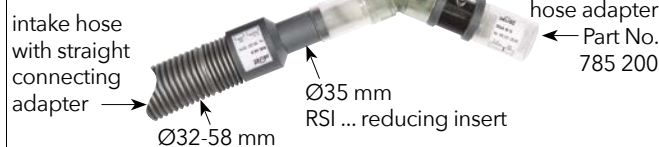

Reducing inserts

For connection between SSA W D intake hose adapter and intake hoses from other manufacturers with different diameters and straight connecting adapter.



General technical data:

Total length (l _G)	105 mm
--------------------------------	--------

Type	RSI 32	RSI 34
Part No.	785 213	785 214
Diameter	35 / 32 mm	35 / 34 mm

Type	RSI 35	RSI 38
Part No.	785 215	785 216
Diameter	35 / 35 mm	35 / 38 mm

Type	RSI 45	RSI 51
Part No.	785 217	785 218
Diameter	35 / 45 mm	35 / 51 mm

Type	RSI 58
Part No.	785 219
Diameter	35 / 58 mm

Tubular brush 80 mm

Cylindrical bristles.



Type	STB 80 ZK MS
Part No.	785 159
Total length (l _G)	250 mm
Diameter	80 mm

Rectangular brush



Type	REB 25055 ZK MS
Part No.	785 169
Dimensions	250 x 55 x 155

Scraper

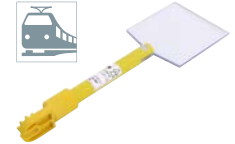

Type	S 100 ZK MS
Part No.	785 329
Total length (l _G)	310 mm
Diameter	100 mm

Cleaning head 55 with scraper

For TRS MS and TFRS MS.

Including 3 spare scrapers.



Type	FD 60 MS SN7271
Part No.	785 225
Total length (l _G)	190 mm
Diameter	40 mm

90° angled flat cleaning head with detachable brush

For TRS NS dry cleaning kits.



Type	FWD 35 P NS
Part No.	785 592
Total length (l _G)	200 mm
Diameter	25 mm

Intake tube with handle

For TRS MS and TFRS MS cleaning kits.



Type	SRH 1180 IS 650 MS
Part No.	785 119
Total length (l _G)	1180 mm, insulating element 650 mm

Canvas bag, empty

With two separate internal pockets and carrier handle.



Type	STT 55 27 30
Part No.	785 111
Dimensions	550 x 270 x 300 mm
Colour	Olive ●

Hand Oiler for Switchgear Installations



- For lubricating movable parts in switchgear installations with a nominal voltage up to 36 kV / 50 Hz
- Transparent insulating hand oiler ensures increased safety
- Easy to use thanks to flexible tip
- If required, the insertion depth of the hand oiler can be increased by means of optional extensions

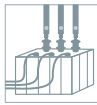

General technical data:

Standard	Based on DIN VDE 0681-1 and DIN VDE 0682-621
Temperature range	+5 °C ... +50 °C
Not for use in wet weather conditions	☀

Hand Oiler



Type	HOEL 36 20 1100
Part No.	785 399
Nominal voltage (U _N)	Up to 36 kV
Total length (l _G)	1160 mm
Volume (oil container)	200 ml

Accessories for Hand Oiler for Switchgear Installations

Extension for hand oiler

Ø20 mm



Type	VL HOEL 20 500
Part No.	785 398
Nominal voltage (U _N)	Up to 36 kV
Total length (l _G)	500 mm
Diameter	20 mm

**DEHN**

DEHNproX - Safe working on
electrical installations / Live working

Arc fault protection at your fingertips

Electrician set for protection against arc faults

Protect your workers from the thermal effects of an arc fault. With our electrician set, you have everything you need for working on electrical systems at your fingertips. Now also available as a configurable set.

- 1x DEHNcare ArcFit protective clothing Indoor or Outdoor
- 1 pair of protective gloves
- 1 x ESH safety helmet for electricians with APS T AS face shield.
- 1 x microfibre bag
- 1 x storage bag

More information here:



DEHN protects.

www.dehn-international.com

Advertisements

DEHNcare - Personal protective equipment

Find the right product quickly and easily: <https://www.dehn-international.com/en/en-dehncare-arcfit>



DEHNcare PPE against arc faults	Page 112
Body Protection	Page 114
Hand Protection	Page 126
Foot Protection	Page 131
Head Protection	Page 132
DEHNcare PPE sets	Page 136
DEHNcare WJP against high-pressure water jets	Page 138
Body Protection	Page 140 /142
Hand Protection	Page 141
Foot Protection	Page 141
Head Protection	Page 142
Size charts	Page 143











In touch with people: personal protective equipment

Arc faults are a serious hazard when working on electrical equipment. High-quality personal protective equipment (PPE) is essential to protect electricians. In this chapter, you will discover

protective clothing of various protection classes specifically designed to protect against the effects of an arc fault. Find out more about our personal protective equipment designed to offer electricians working in electrical hazard areas protection and comfort.



More information and images about personal protective equipment against the thermal effects of electric fault arcs can be found here:

Type / Application	Product	Page
<p>Body protection - DEHNcare ArcFit Indoor and Outdoor *)</p> <p>Arc-fault-tested protective clothing</p> <ul style="list-style-type: none"> Protective jacket and trousers Protection from the thermal effects of an arc fault when working on electrical installations Arc flash protection class APC 2 or PPE 2 Multinorm clothing 		<p>114</p> <p>117</p>
<p>Body protection - DEHNcare UnderWear</p> <p>Accessories for arc-fault-tested protective clothing</p> <ul style="list-style-type: none"> An elevated level of protection is provided when combined with DEHNcare ArcFit Undershirt and pants Polo shirt 		123
<p>Body protection - DEHNcare ArcFit HLP 63 *)</p> <p>Arc-fault-tested protective clothing</p> <ul style="list-style-type: none"> Protective jacket and trousers (bib overall) Protection from the thermal effects of an arc fault when working on electrical installations Arc flash protection class APC 2 or PPE 4 Multinorm clothing 		124
<p>Body protection - DEHNcare ArcClassic *)</p> <p>Arc-fault-tested protective clothing</p> <ul style="list-style-type: none"> Protective coat, jacket and trousers Protection from the thermal effects of an arc fault when working on electrical installations Arc flash protection class APC 2 or PPE 3 		125
<p>Hand protection - DEHNcare *)</p> <p>DEHNcare APG XT</p> <p>DEHNcare APG</p> <p>Insulating gloves up to 1000 V</p> <p>Insulating gloves up to 36 kV</p>		<p>126</p> <p>128</p> <p>128</p> <p>130</p>
<p>Foot protection - DEHNcare</p> <p>Safety shoes with insulating soles up to 1000 V</p>		131
<p>DEHNcare - Head protection</p> <p>DEHNcare APS with active protection</p> <p>Balaclava</p> <p>DEHNcare APS with headgear</p> <p>DEHNcare APS with lever arms</p> <p>DEHNcare APHO</p> <p>ESH U S safety helmet for electricians</p>		<p>132</p> <p>133</p> <p>133</p> <p>134</p> <p>134</p> <p>135</p>
<p>DEHNcare PPE sets - Indoor and Outdoor</p> <p>Appropriate starter set for electricians for outdoor and indoor use</p>		136
<p>DEHNcare WJP (Water Jet Protection) *)</p> <p>Personal protective equipment against high pressure water jets</p> <p>Protective overall "Advanced" up to 1000 bar</p> <p>Protective gloves up to 1000 bar</p> <p>Protective socks up to 1000 bar - in combination with S5 rubber safety boots</p> <p>Protective overall "Basic" up to 750 bar</p> <p>Head protection set</p>		<p>140</p> <p>141</p> <p>141</p> <p>142</p> <p>142</p>

DEHNcare ArcFit Indoor



Arc-fault-tested protective clothing for everyday use.

The multinorm all-rounder: the all-round single-layer material ensures great mobility for all activities, a perfect fit for every figure and a comfortable feeling all day long.

- Environmentally friendly - washable up to 60°
- Individual design - personal online configuration
- Certified according to PPE regulation (EU) 2016/425

Arc-fault-tested protective jacket, standard men's sizes



General technical data:	
Arc fault protection class (box test 7 kA / 0.5 s - single-pole)	APC 2
Arc energy (W _{arc} or W _{LBP})	320 kJ
Arc Rating - ATPV (Open Arc)	18 cal / cm ² *)
Arc Rating - ELIM (Open Arc)	13 cal / cm ²
PPE category (NFPA 70E)	PPE 2
Weight per unit area	450 g/m ²
Primary colour	grey
Secondary colour	black
Zipper	red
Design code	JIGRBLRE0000P0000

Type	APJ ID 42	APJ ID 44
Part No.	787 600 NEW	787 601 NEW
Size (international)	42 (2XS)	44 (2XS/XS)

Type	APJ ID 46	APJ ID 48
Part No.	785 330	785 331
Size (international)	46 (XS)	48 (S)

Type	APJ ID 50	APJ ID 52
Part No.	785 332	785 333
Size (international)	50 (M)	52 (M/L)

Type	APJ ID 54	APJ ID 56
Part No.	785 334	785 335
Size (international)	54 (L)	56 (XL)

Type	APJ ID 58	APJ ID 60
Part No.	785 336	785 337
Size (international)	58 (XL/2XL)	60 (2XL)

Type	APJ ID 62	APJ ID 64
Part No.	785 338	787 602 NEW
Size (international)	62 (3XL)	64 (3XL/4XL)

Type	APJ ID 66	APJ ID 68
Part No.	787 603 NEW	787 604 NEW
Size (international)	66 (4XL)	68 (4XL/5XL)

*) Outer fabric after preparation

General technical data:	
Standard	IEC 61482-2, EN ISO 11612, EN 1149-5, EN ISO 13688, EN ISO 11611, EN 17353
Material	Cotton (52%), modacrylic (22%), viscose (19%), para-aramid (6%), static inhibitors (1%)
Material (sewing thread)	Kevlar (100%)



Safety at a glance!



Elastic cuff



Configure your DEHNcare ArcFit according to your ideas.

Arc-fault-tested protective trousers, standard men's sizes



General technical data:	
Arc fault protection class (box test 7 kA / 0.5 s - single-pole)	APC 2
Arc energy (W _{arc} or W _{LBP})	320 kJ
Arc Rating - ATPV (Open Arc)	18 cal / cm ² *)
Arc Rating - ELIM (Open Arc)	13 cal / cm ²
PPE category (NFPA 70E)	PPE 2
Weight per unit area	450 g/m ²
Primary colour	grey
Secondary colour	black
Zipper	red
Design code	TIGRBLRE0000P0

Type	APT ID 42	APT ID 44
Part No.	787 650 NEW	787 651 NEW
Size (international)	42 (2XS)	44 (2XS/XS)

Type	APT ID 46	APT ID 48
Part No.	785 340	785 341
Size (international)	46 (XS)	48 (S)

Type	APT ID 50	APT ID 52
Part No.	785 342	785 343
Size (international)	50 (M)	52 (M/L)

Type	APT ID 54	APT ID 56
Part No.	785 344	785 345
Size (international)	54 (L)	56 (XL)

Type	APT ID 58	APT ID 60
Part No.	785 346	785 347
Size (international)	58 (XL/2XL)	60 (2XL)

Type	APT ID 62	APT ID 64
Part No.	785 348	787 652 NEW
Size (international)	62 (3XL)	64 (3XL/4XL)

Type	APT ID 66	APT ID 68
Part No.	787 653 NEW	787 654 NEW
Size (international)	66 (4XL)	68 (4XL/5XL)

*) Outer fabric after preparation

Arc-fault-tested protective jacket, men's short sizes



General technical data:	
Arc fault protection class (box test 7 kA / 0.5 s - single-pole)	APC 2
Arc energy (W _{arc} or W _{LBP})	320 kJ
Arc Rating - ATPV (Open Arc)	18 cal / cm ² *)
Arc Rating - ELIM (Open Arc)	13 cal / cm ²
PPE category (NFPA 70E)	PPE 2
Weight per unit area	450 g/m ²
Primary colour	grey
Secondary colour	black
Zipper	red
Design code	JIGRBLRE0000P0000

Type	APJ ID 22	APJ ID 23
Part No.	787 610 <small>NEW</small>	787 611 <small>NEW</small>
Size (international)	22 (2XS/XS-K)	23 (XS-K)

Type	APJ ID 24	APJ ID 25
Part No.	787 612 <small>NEW</small>	787 613 <small>NEW</small>
Size (international)	24 (S-K)	25 (M-K)

Type	APJ ID 26	APJ ID 27
Part No.	787 614 <small>NEW</small>	787 615 <small>NEW</small>
Size (international)	26 (M/L-K)	27 (L-K)

Type	APJ ID 28	APJ ID 29
Part No.	787 616 <small>NEW</small>	787 617 <small>NEW</small>
Size (international)	28 (XL-K)	29 (XL/2XL-K)

Type	APJ ID 30
Part No.	787 618 <small>NEW</small>
Size (international)	30 (2XL-K)

*) Outer fabric after preparation

Arc-fault-tested protective jacket, men's long sizes



General technical data:	
Arc fault protection class (box test 7 kA / 0.5 s - single-pole)	APC 2
Arc energy (W _{arc} or W _{LBP})	320 kJ
Arc Rating - ATPV (Open Arc)	18 cal / cm ² *)
Arc Rating - ELIM (Open Arc)	13 cal / cm ²
PPE category (NFPA 70E)	PPE 2
Weight per unit area	450 g/m ²
Primary colour	grey
Secondary colour	black
Zipper	red
Design code	JIGRBLRE0000P0000

Type	APJ ID 90	APJ ID 94
Part No.	787 620 <small>NEW</small>	787 621 <small>NEW</small>
Size (international)	90 (XS-L)	94 (S-L)

Type	APJ ID 98	APJ ID 102
Part No.	787 622 <small>NEW</small>	787 623 <small>NEW</small>
Size (international)	98 (M-L)	102 (M/L-L)

Type	APJ ID 106	APJ ID 110
Part No.	787 624 <small>NEW</small>	787 625 <small>NEW</small>
Size (international)	106 (L-L)	110 (XL-L)

Type	APJ ID 114	APJ ID 118
Part No.	787 626 <small>NEW</small>	787 627 <small>NEW</small>
Size (international)	114 (XL/2XL-L)	118 (2XL-L)

*) Outer fabric after preparation

Arc-fault-tested protective trousers, men's short sizes



General technical data:	
Arc fault protection class (box test 7 kA / 0.5 s - single-pole)	APC 2
Arc energy (W _{arc} or W _{LBP})	320 kJ
Arc Rating - ATPV (Open Arc)	18 cal / cm ² *)
Arc Rating - ELIM (Open Arc)	13 cal / cm ²
PPE category (NFPA 70E)	PPE 2
Weight per unit area	450 g/m ²
Primary colour	grey
Secondary colour	black
Zipper	red
Design code	TIGRBLRE0000P0

Type	APT ID 22	APT ID 23
Part No.	787 660 <small>NEW</small>	787 661 <small>NEW</small>
Size (international)	22 (2XS/XS-K)	23 (XS-K)

Type	APT ID 24	APT ID 25
Part No.	787 662 <small>NEW</small>	787 663 <small>NEW</small>
Size (international)	24 (S-K)	25 (M-K)

Type	APT ID 26	APT ID 27
Part No.	787 664 <small>NEW</small>	787 665 <small>NEW</small>
Size (international)	26 (M/L-K)	27 (L-K)

Type	APT ID 28	APT ID 29
Part No.	787 666 <small>NEW</small>	787 667 <small>NEW</small>
Size (international)	28 (XL-K)	29 (XL/2XL-K)

Type	APT ID 30
Part No.	787 668 <small>NEW</small>
Size (international)	30 (2XL-K)

*) Outer fabric after preparation

Arc-fault-tested protective trousers, men's long sizes



General technical data:	
Arc fault protection class (box test 7 kA / 0.5 s - single-pole)	APC 2
Arc energy (W _{arc} or W _{LBP})	320 kJ
Arc Rating - ATPV (Open Arc)	18 cal / cm ² *)
Arc Rating - ELIM (Open Arc)	13 cal / cm ²
PPE category (NFPA 70E)	PPE 2
Weight per unit area	450 g/m ²
Primary colour	grey
Secondary colour	black
Zipper	red
Design code	TIGRBLRE0000P0

Type	APT ID 90	APT ID 94
Part No.	787 670 <small>NEW</small>	787 671 <small>NEW</small>
Size (international)	90 (XS-L)	94 (S-L)

Type	APT ID 98	APT ID 102
Part No.	787 672 <small>NEW</small>	787 673 <small>NEW</small>
Size (international)	98 (M-L)	102 (M/L-L)

Type	APT ID 106	APT ID 110
Part No.	787 674 <small>NEW</small>	787 675 <small>NEW</small>
Size (international)	106 (L-L)	110 (XL-L)

Type	APT ID 114	APT ID 118
Part No.	787 676 <small>NEW</small>	787 677 <small>NEW</small>
Size (international)	114 (XL/2XL-L)	118 (2XL-L)

*) Outer fabric after preparation

Arc-fault-tested protective jacket, standard ladies' sizes



General technical data:	
Arc fault protection class (box test 7 kA / 0.5 s - single-pole)	APC 2
Arc energy (W _{arc} or W _{LBP})	320 kJ
Arc Rating - ATPV (Open Arc)	18 cal / cm ² *)
Arc Rating - ELIM (Open Arc)	13 cal / cm ²
PPE category (NFPA 70E)	PPE 2
Weight per unit area	450 g/m ²
Primary colour	grey
Secondary colour	black
Zipper	red
Design code	JIGRBLRE0000P0000

Type	APJ ID F 34	APJ ID F 36
Part No.	787 630 NEW	787 631 NEW
Size (international)	34 (XS)	36 (S)

Type	APJ ID F 38	APJ ID F 40
Part No.	787 632 NEW	787 633 NEW
Size (international)	38 (M)	40 (M/L)

Type	APJ ID F 42	APJ ID F 44
Part No.	787 634 NEW	787 635 NEW
Size (international)	42 (L)	44 (XL)

Type	APJ ID F 46	APJ ID F 48
Part No.	787 636 NEW	787 637 NEW
Size (international)	46 (XL/2XL)	48 (2XL)

Type	APJ ID F 50	APJ ID F 52
Part No.	787 638 NEW	787 639 NEW
Size (international)	50 (2XL/3XL)	52 (3XL)

Type	APJ ID F 54	APJ ID F 56
Part No.	787 640 NEW	787 641 NEW
Size (international)	54 (3XL/4XL)	56 (4XL)

*) Outer fabric after preparation

Arc-fault-tested protective jacket - configurable



Type	APJ ID KONFI
Part No.	785 339
Arc fault protection class (box test 7 kA / 0.5 s - single-pole)	APC 2
Arc energy (W _{arc} or W _{LBP})	320 kJ
Arc Rating - ATPV (Open Arc)	18 cal / cm ² *)
Arc Rating - ELIM (Open Arc)	13 cal / cm ²
PPE category (NFPA 70E)	PPE 2
Weight per unit area	450 g/m ²
Configurable:	
Primary colour	grey / black / dark blue / red / orange
Secondary colour	black / dark blue / red / orange
Zipper	red / black
Logo	yes / no
Logo position (1-4)	chest right / stand-up collar left / stand-up collar back / back
Name	yes / no (max. 22 characters)
Size (international)	from 46 (XS) to 62 (3XL)
Design code / Attention: Please indicate the unique design code when ordering	

*) Outer fabric after preparation

Arc-fault-tested protective trousers, standard ladies' sizes



General technical data:	
Arc fault protection class (box test 7 kA / 0.5 s - single-pole)	APC 2
Arc energy (W _{arc} or W _{LBP})	320 kJ
Arc Rating - ATPV (Open Arc)	18 cal / cm ² *)
Arc Rating - ELIM (Open Arc)	13 cal / cm ²
PPE category (NFPA 70E)	PPE 2
Weight per unit area	450 g/m ²
Primary colour	grey
Secondary colour	black
Zipper	red
Design code	TIGRBLRE0000P0

Type	APT ID F 34	APT ID F 36
Part No.	787 680 NEW	787 681 NEW
Size (international)	34 (XS)	36 (S)

Type	APT ID F 38	APT ID F 40
Part No.	787 682 NEW	787 683 NEW
Size (international)	38 (M)	40 (M/L)

Type	APT ID F 42	APT ID F 44
Part No.	787 684 NEW	787 685 NEW
Size (international)	42 (L)	44 (XL)

Type	APT ID F 46	APT ID F 48
Part No.	787 686 NEW	787 687 NEW
Size (international)	46 (XL/2XL)	48 (2XL)

Type	APT ID F 50	APT ID F 52
Part No.	787 688 NEW	787 689 NEW
Size (international)	50 (2XL/3XL)	52 (3XL)

Type	APT ID F 54	APT ID F 56
Part No.	787 690 NEW	787 691 NEW
Size (international)	54 (3XL/4XL)	56 (4XL)

*) Outer fabric after preparation

Arc-fault-tested protective trousers - configurable



Type	APT ID KONFI
Part No.	785 349
Arc fault protection class (box test 7 kA / 0.5 s - single-pole)	APC 2
Arc energy (W _{arc} or W _{LBP})	320 kJ
Arc Rating - ATPV (Open Arc)	18 cal / cm ² *)
Arc Rating - ELIM (Open Arc)	13 cal / cm ²
PPE category (NFPA 70E)	PPE 2
Weight per unit area	450 g/m ²
Configurable:	
Primary colour	grey / black / dark blue / red / orange
Secondary colour	grey / black / dark blue / red / orange
Zipper	red / black
Logo	yes / no
Logo position (5)	Pocket left trouser leg
Size (international)	from 46 (XS) to 62 (3XL)
Design code / Attention: Please indicate the unique design code when ordering	

*) Outer fabric after preparation

DEHNcare ArcFit Outdoor



Arc-fault-tested protective clothing with special properties for outdoor areas.

Best visibility to protect against accidents in any outdoor situation: this multinorm all-rounder fits every employee thanks to the variety of sizes and its modern cut. This clothing is comfortable all day due to its single layer material.

- Dirt-repellent and water-repellent
- Environmentally friendly - washable up to 60°
- Individual design - personal online configuration
- Certified according to PPE regulation (EU) 2016/425

Arc-fault-tested protective jacket - fluorescent yellow, standard men's sizes



General technical data:	
Arc fault protection class (box test 7 kA / 0.5 s - single-pole)	APC 2
Arc energy (W _{arc} or W _{LBP})	320 kJ
Arc rating - ATPV (open arc)	16 cal / cm ² *)
Arc rating - ELIM (open arc)	13 cal / cm ²
PPE category (NFPA 70E)	PPE 2
Weight per unit area	300 g/m ²
Primary colour	fluorescent yellow
Secondary colour	grey
Zipper	red
Design code	JOYEGRRE0000P0000

Type	APJ OD YE 42	APJ OD YE 44
Part No.	787 700 NEW	787 701 NEW
Size (international)	42 (2XS)	44 (2XS/XS)

Type	APJ OD YE 46	APJ OD YE 48
Part No.	785 350	785 351
Size (international)	46 (XS)	48 (S)

Type	APJ OD YE 50	APJ OD YE 52
Part No.	785 352	785 353
Size (international)	50 (M)	52 (M/L)

Type	APJ OD YE 54	APJ OD YE 56
Part No.	785 354	785 355
Size (international)	54 (L)	56 (XL)

Type	APJ OD YE 58	APJ OD YE 60
Part No.	785 356	785 357
Size (international)	58 (XL/2XL)	60 (2XL)

Type	APJ OD YE 62	APJ OD YE 64
Part No.	785 358	787 702 NEW
Size (international)	62 (3XL)	64 (3XL/4XL)

Type	APJ OD YE 66	APJ OD YE 68
Part No.	787 703 NEW	787 704 NEW
Size (international)	66 (4XL)	68 (4XL/5XL)

*) Outer fabric after preparation

General technical data:	
Standard	IEC 61482-2, EN ISO 11612, EN 1149-5, EN ISO 20471, EN 13034, EN ISO 13688, EN ISO 11611
Material	Modacrylic (40%), viscose (59%), static inhibitors (1%), PU membrane: meta-armid knitting (100%)
Material (sewing thread)	Kevlar (100%)



Safety at a glance! Flame-resistant red zippers



Fully concealed zippers prevent the penetration of liquids



Arc-fault-tested protective trousers - fluorescent yellow, standard men's sizes



Configure your DEHNcare ArcFit according to your ideas.

General technical data:	
Arc fault protection class (box test 7 kA / 0.5 s - single-pole)	APC 2
Arc energy (W _{arc} or W _{LBP})	320 kJ
Arc rating - ATPV (open arc)	16 cal / cm ² *)
Arc rating - ELIM (open arc)	13 cal / cm ²
PPE category (NFPA 70E)	PPE 2
Weight per unit area	300 g/m ²
Primary colour	fluorescent yellow
Secondary colour	grey
Zipper	red
Design code	TOYEGRRE0000P0

Type	APT OD YE 42	APT OD YE 44
Part No.	787 750 NEW	787 751 NEW
Size (international)	42 (2XS)	44 (2XS/XS)

Type	APT OD YE 46	APT OD YE 48
Part No.	785 360	785 361
Size (international)	46 (XS)	48 (S)

Type	APT OD YE 50	APT OD YE 52
Part No.	785 362	785 363
Size (international)	50 (M)	52 (M/L)

Type	APT OD YE 54	APT OD YE 56
Part No.	785 364	785 365
Size (international)	54 (L)	56 (XL)

Type	APT OD YE 58	APT OD YE 60
Part No.	785 366	785 367
Size (international)	58 (XL/2XL)	60 (2XL)

Type	APT OD YE 62	APT OD YE 64
Part No.	785 368	787 752 NEW
Size (international)	62 (3XL)	64 (3XL/4XL)

Type	APT OD YE 66	APT OD YE 68
Part No.	787 753 NEW	787 754 NEW
Size (international)	66 (4XL)	68 (4XL/5XL)

*) Outer fabric after preparation

Arc-fault-tested protective jacket - fluorescent yellow, men's short sizes



General technical data:	
Arc fault protection class (box test 7 kA / 0.5 s - single-pole)	APC 2
Arc energy (W _{arc} or W _{LBP})	320 kJ
Arc rating - ATPV (open arc)	16 cal / cm ² *)
Arc rating - ELIM (open arc)	13 cal / cm ²
PPE category (NFPA 70E)	PPE 2
Weight per unit area	300 g/m ²
Primary colour	fluorescent yellow
Secondary colour	grey
Zipper	red
Design code	JOYEGRRE0000P0000

Type	APJ OD YE 22	APJ OD YE 23
Part No.	787 710 <small>NEW</small>	787 711 <small>NEW</small>
Size (international)	22 (2XS/XS-K)	23 (XS-K)

Type	APJ OD YE 24	APJ OD YE 25
Part No.	787 712 <small>NEW</small>	787 713 <small>NEW</small>
Size (international)	24 (S-K)	25 (M-K)

Type	APJ OD YE 26	APJ OD YE 27
Part No.	787 714 <small>NEW</small>	787 715 <small>NEW</small>
Size (international)	26 (M/L-K)	27 (L-K)

Type	APJ OD YE 28	APJ OD YE 29
Part No.	787 716 <small>NEW</small>	787 717 <small>NEW</small>
Size (international)	28 (XL-K)	29 (XL/2XL-K)

Type	APJ OD YE 30
Part No.	787 718 <small>NEW</small>
Size (international)	30 (2XL-K)

*) Outer fabric after preparation

Arc-fault-tested protective jacket - fluorescent yellow, men's long sizes



General technical data:	
Arc fault protection class (box test 7 kA / 0.5 s - single-pole)	APC 2
Arc energy (W _{arc} or W _{LBP})	320 kJ
Arc rating - ATPV (open arc)	16 cal / cm ² *)
Arc rating - ELIM (open arc)	13 cal / cm ²
PPE category (NFPA 70E)	PPE 2
Weight per unit area	300 g/m ²
Primary colour	fluorescent yellow
Secondary colour	grey
Zipper	red
Design code	JOYEGRRE0000P0000

Type	APJ OD YE 90	APJ OD YE 94
Part No.	787 720 <small>NEW</small>	787 721 <small>NEW</small>
Size (international)	90 (XS-L)	94 (S-L)

Type	APJ OD YE 98	APJ OD YE 102
Part No.	787 722 <small>NEW</small>	787 723 <small>NEW</small>
Size (international)	98 (M-L)	102 (M/L-L)

Type	APJ OD YE 106	APJ OD YE 110
Part No.	787 724 <small>NEW</small>	787 725 <small>NEW</small>
Size (international)	106 (L-L)	110 (XL-L)

Type	APJ OD YE 114	APJ OD YE 118
Part No.	787 726 <small>NEW</small>	787 727 <small>NEW</small>
Size (international)	114 (XL/2XL-L)	118 (2XL-L)

*) Outer fabric after preparation

Arc-fault-tested protective trousers - fluorescent yellow, men's short sizes



General technical data:	
Arc fault protection class (box test 7 kA / 0.5 s - single-pole)	APC 2
Arc energy (W _{arc} or W _{LBP})	320 kJ
Arc rating - ATPV (open arc)	16 cal / cm ² *)
Arc rating - ELIM (open arc)	13 cal / cm ²
PPE category (NFPA 70E)	PPE 2
Weight per unit area	300 g/m ²
Primary colour	fluorescent yellow
Secondary colour	grey
Zipper	red
Design code	TOYEGRRE0000P0

Type	APT OD YE 22	APT OD YE 23
Part No.	787 760 <small>NEW</small>	787 761 <small>NEW</small>
Size (international)	22 (2XS/XS-K)	23 (XS-K)

Type	APT OD YE 24	APT OD YE 25
Part No.	787 762 <small>NEW</small>	787 763 <small>NEW</small>
Size (international)	24 (S-K)	25 (M-K)

Type	APT OD YE 26	APT OD YE 27
Part No.	787 764 <small>NEW</small>	787 765 <small>NEW</small>
Size (international)	26 (M/L-K)	27 (L-K)

Type	APT OD YE 28	APT OD YE 29
Part No.	787 766 <small>NEW</small>	787 767 <small>NEW</small>
Size (international)	28 (XL-K)	29 (XL/2XL-K)

Type	APT OD YE 30
Part No.	787 768 <small>NEW</small>
Size (international)	30 (2XL-K)

*) Outer fabric after preparation

Arc-fault-tested protective trousers - fluorescent yellow, men's long sizes



General technical data:	
Arc fault protection class (box test 7 kA / 0.5 s - single-pole)	APC 2
Arc energy (W _{arc} or W _{LBP})	320 kJ
Arc rating - ATPV (open arc)	16 cal / cm ² *)
Arc rating - ELIM (open arc)	13 cal / cm ²
PPE category (NFPA 70E)	PPE 2
Weight per unit area	300 g/m ²
Primary colour	fluorescent yellow
Secondary colour	grey
Zipper	red
Design code	TOYEGRRE0000P0

Type	APT OD YE 90	APT OD YE 94
Part No.	787 770 <small>NEW</small>	787 771 <small>NEW</small>
Size (international)	90 (XS-L)	94 (S-L)

Type	APT OD YE 98	APT OD YE 102
Part No.	787 772 <small>NEW</small>	787 773 <small>NEW</small>
Size (international)	98 (M-L)	102 (M/L-L)

Type	APT OD YE 106	APT OD YE 110
Part No.	787 774 <small>NEW</small>	787 775 <small>NEW</small>
Size (international)	106 (L-L)	110 (XL-L)

Type	APT OD YE 114	APT OD YE 118
Part No.	787 776 <small>NEW</small>	787 777 <small>NEW</small>
Size (international)	114 (XL/2XL-L)	118 (2XL-L)

*) Outer fabric after preparation

Arc-fault-tested protective jacket - fluorescent yellow, standard ladies' sizes



General technical data:

Arc fault protection class (box test 7 kA / 0.5 s - single-pole)	APC 2
Arc energy (W _{arc} or W _{LBP})	320 kJ
Arc rating - ATPV (open arc)	16 cal / cm ² *)
Arc rating - ELIM (open arc)	13 cal / cm ²
PPE category (NFPA 70E)	PPE 2
Weight per unit area	300 g/m ²
Primary colour	fluorescent yellow
Secondary colour	grey
Zipper	red
Design code	JOYEGRRE0000P0000

Type	APJ OD YE F 34	APJ OD YE F 36
Part No.	787 730 <small>NEW</small>	787 731 <small>NEW</small>
Size (international)	34 (XS)	36 (S)

Type	APJ OD YE F 38	APJ OD YE F 40
Part No.	787 732 <small>NEW</small>	787 733 <small>NEW</small>
Size (international)	38 (M)	40 (M/L)

Type	APJ OD YE F 42	APJ OD YE F 44
Part No.	787 734 <small>NEW</small>	787 735 <small>NEW</small>
Size (international)	42 (L)	44 (XL)

Type	APJ OD YE F 46	APJ OD YE F 48
Part No.	787 736 <small>NEW</small>	787 737 <small>NEW</small>
Size (international)	46 (XL/2XL)	48 (2XL)

Type	APJ OD YE F 50	APJ OD YE F 52
Part No.	787 738 <small>NEW</small>	787 739 <small>NEW</small>
Size (international)	50 (2XL/3XL)	52 (3XL)

Type	APJ OD YE F 54	APJ OD YE F 56
Part No.	787 740 <small>NEW</small>	787 741 <small>NEW</small>
Size (international)	54 (3XL/4XL)	56 (4XL)

*) Outer fabric after preparation

Arc-fault-tested protective trousers - fluorescent yellow, standard ladies' sizes



General technical data:

Arc fault protection class (box test 7 kA / 0.5 s - single-pole)	APC 2
Arc energy (W _{arc} or W _{LBP})	320 kJ
Arc rating - ATPV (open arc)	16 cal / cm ² *)
Arc rating - ELIM (open arc)	13 cal / cm ²
PPE category (NFPA 70E)	PPE 2
Weight per unit area	300 g/m ²
Primary colour	fluorescent yellow
Secondary colour	grey
Zipper	red
Design code	TOYEGRRE0000P0

Type	APT OD YE F 34	APT OD YE F 36
Part No.	787 780 <small>NEW</small>	787 781 <small>NEW</small>
Size (international)	34 (XS)	36 (S)

Type	APT OD YE F 38	APT OD YE F 40
Part No.	787 782 <small>NEW</small>	787 783 <small>NEW</small>
Size (international)	38 (M)	40 (M/L)

Type	APT OD YE F 42	APT OD YE F 44
Part No.	787 784 <small>NEW</small>	787 785 <small>NEW</small>
Size (international)	42 (L)	44 (XL)

Type	APT OD YE F 46	APT OD YE F 48
Part No.	787 786 <small>NEW</small>	787 787 <small>NEW</small>
Size (international)	46 (XL/2XL)	48 (2XL)

Type	APT OD YE F 50	APT OD YE F 52
Part No.	787 788 <small>NEW</small>	787 789 <small>NEW</small>
Size (international)	50 (2XL/3XL)	52 (3XL)

Type	APT OD YE F 54	APT OD YE F 56
Part No.	787 790 <small>NEW</small>	787 791 <small>NEW</small>
Size (international)	54 (3XL/4XL)	56 (4XL)

*) Outer fabric after preparation



Arc-fault-tested protective jacket - fluorescent orange, standard men's sizes



General technical data:	
Arc fault protection class (box test 7 kA / 0.5 s - single-pole)	APC 2
Arc energy (W _{arc} or W _{LBP})	320 kJ
Arc rating - ATPV (open arc)	16 cal / cm ² *)
Arc rating - ELIM (open arc)	13 cal / cm ²
PPE category (NFPA 70E)	PPE 2
Weight per unit area	300 g/m ²
Primary colour	fluorescent orange
Secondary colour	grey
Zipper	red
Design code	JOORGRRE0000P0000

Type	APJ OD OG 42	APJ OD OG 44
Part No.	787 800 <small>NEW</small>	787 801 <small>NEW</small>
Size (international)	42 (2XS)	44 (2XS/XS)

Type	APJ OD OG 46	APJ OD OG 48
Part No.	787 350 <small>NEW</small>	787 351 <small>NEW</small>
Size (international)	46 (XS)	48 (S)

Type	APJ OD OG 50	APJ OD OG 52
Part No.	787 352 <small>NEW</small>	787 353 <small>NEW</small>
Size (international)	50 (M)	52 (M/L)

Type	APJ OD OG 54	APJ OD OG 56
Part No.	787 354 <small>NEW</small>	787 355 <small>NEW</small>
Size (international)	54 (L)	56 (XL)

Type	APJ OD OG 58	APJ OD OG 60
Part No.	787 356 <small>NEW</small>	787 357 <small>NEW</small>
Size (international)	58 (XL/2XL)	60 (2XL)

Type	APJ OD OG 62	APJ OD OG 64
Part No.	787 358 <small>NEW</small>	787 802 <small>NEW</small>
Size (international)	62 (3XL)	64 (3XL/4XL)

Type	APJ OD OG 66	APJ OD OG 68
Part No.	787 803 <small>NEW</small>	787 804 <small>NEW</small>
Size (international)	66 (4XL)	68 (4XL/5XL)

*) Outer fabric after preparation

Arc-fault-tested protective trousers - fluorescent orange, standard men's sizes



General technical data:	
Arc fault protection class (box test 7 kA / 0.5 s - single-pole)	APC 2
Arc energy (W _{arc} or W _{LBP})	320 kJ
Arc rating - ATPV (open arc)	16 cal / cm ² *)
Arc rating - ELIM (open arc)	13 cal / cm ²
PPE category (NFPA 70E)	PPE 2
Weight per unit area	300 g/m ²
Primary colour	fluorescent orange
Secondary colour	grey
Zipper	red
Design code	TOORGRRE0000P0

Type	APT OD OG 42	APT OD OG 44
Part No.	787 850 <small>NEW</small>	787 851 <small>NEW</small>
Size (international)	42 (2XS)	44 (2XS/XS)

Type	APT OD OG 46	APT OD OG 48
Part No.	787 360 <small>NEW</small>	787 361 <small>NEW</small>
Size (international)	46 (XS)	48 (S)

Type	APT OD OG 50	APT OD OG 52
Part No.	787 362 <small>NEW</small>	787 363 <small>NEW</small>
Size (international)	50 (M)	52 (M/L)

Type	APT OD OG 54	APT OD OG 56
Part No.	787 364 <small>NEW</small>	787 365 <small>NEW</small>
Size (international)	54 (L)	56 (XL)

Type	APT OD OG 58	APT OD OG 60
Part No.	787 366 <small>NEW</small>	787 367 <small>NEW</small>
Size (international)	58 (XL/2XL)	60 (2XL)

Type	APT OD OG 62	APT OD OG 64
Part No.	787 368 <small>NEW</small>	787 852 <small>NEW</small>
Size (international)	62 (3XL)	64 (3XL/4XL)

Type	APT OD OG 66	APT OD OG 68
Part No.	787 853 <small>NEW</small>	787 854 <small>NEW</small>
Size (international)	66 (4XL)	68 (4XL/5XL)

*) Outer fabric after preparation



Arc-fault-tested protective jacket - fluorescent orange, men's short sizes



General technical data:	
Arc fault protection class (box test 7 kA / 0.5 s - single-pole)	APC 2
Arc energy (W _{arc} or W _{LBP})	320 kJ
Arc rating - ATPV (open arc)	16 cal / cm ² *)
Arc rating - ELIM (open arc)	13 cal / cm ²
PPE category (NFPA 70E)	PPE 2
Weight per unit area	300 g/m ²
Primary colour	fluorescent orange
Secondary colour	grey
Zipper	red
Design code	JOORGRRE0000P0000

Type	APJ OD OG 22	APJ OD OG 23
Part No.	787 810 <small>NEW</small>	787 811 <small>NEW</small>
Size (international)	22 (2XS/XS-K)	23 (XS-K)

Type	APJ OD OG 24	APJ OD OG 25
Part No.	787 812 <small>NEW</small>	787 813 <small>NEW</small>
Size (international)	24 (S-K)	25 (M-K)

Type	APJ OD OG 26	APJ OD OG 27
Part No.	787 814 <small>NEW</small>	787 815 <small>NEW</small>
Size (international)	26 (M/L-K)	27 (L-K)

Type	APJ OD OG 28	APJ OD OG 29
Part No.	787 816 <small>NEW</small>	787 817 <small>NEW</small>
Size (international)	28 (XL-K)	29 (XL/2XL-K)

Type	APJ OD OG 30
Part No.	787 818 <small>NEW</small>
Size (international)	30 (2XL-K)

*) Outer fabric after preparation

Arc-fault-tested protective jacket - fluorescent orange, men's long sizes



General technical data:	
Arc fault protection class (box test 7 kA / 0.5 s - single-pole)	APC 2
Arc energy (W _{arc} or W _{LBP})	320 kJ
Arc rating - ATPV (open arc)	16 cal / cm ² *)
Arc rating - ELIM (open arc)	13 cal / cm ²
PPE category (NFPA 70E)	PPE 2
Weight per unit area	300 g/m ²
Primary colour	fluorescent orange
Secondary colour	grey
Zipper	red
Design code	JOORGRRE0000P0000

Type	APJ OD OG 90	APJ OD OG 94
Part No.	787 820 <small>NEW</small>	787 821 <small>NEW</small>
Size (international)	90 (XS-L)	94 (S-L)

Type	APJ OD OG 98	APJ OD OG 102
Part No.	787 822 <small>NEW</small>	787 823 <small>NEW</small>
Size (international)	98 (M-L)	102 (M/L-L)

Type	APJ OD OG 106	APJ OD OG 110
Part No.	787 824 <small>NEW</small>	787 825 <small>NEW</small>
Size (international)	106 (L-L)	110 (XL-L)

Type	APJ OD OG 114	APJ OD OG 118
Part No.	787 826 <small>NEW</small>	787 827 <small>NEW</small>
Size (international)	114 (XL/2XL-L)	118 (2XL-L)

*) Outer fabric after preparation

Arc-fault-tested protective trousers - fluorescent orange, men's short sizes



General technical data:	
Arc fault protection class (box test 7 kA / 0.5 s - single-pole)	APC 2
Arc energy (W _{arc} or W _{LBP})	320 kJ
Arc rating - ATPV (open arc)	16 cal / cm ² *)
Arc rating - ELIM (open arc)	13 cal / cm ²
PPE category (NFPA 70E)	PPE 2
Weight per unit area	300 g/m ²
Primary colour	fluorescent orange
Secondary colour	grey
Zipper	red
Design code	TOORGRRE0000P0

Type	APT OD OG 22	APT OD OG 23
Part No.	787 860 <small>NEW</small>	787 861 <small>NEW</small>
Size (international)	22 (2XS/XS-K)	23 (XS-K)

Type	APT OD OG 24	APT OD OG 25
Part No.	787 862 <small>NEW</small>	787 863 <small>NEW</small>
Size (international)	24 (S-K)	25 (M-K)

Type	APT OD OG 26	APT OD OG 27
Part No.	787 864 <small>NEW</small>	787 865 <small>NEW</small>
Size (international)	26 (M/L-K)	27 (L-K)

Type	APT OD OG 28	APT OD OG 29
Part No.	787 866 <small>NEW</small>	787 867 <small>NEW</small>
Size (international)	28 (XL-K)	29 (XL/2XL-K)

Type	APT OD OG 30
Part No.	787 868 <small>NEW</small>
Size (international)	30 (2XL-K)

*) Outer fabric after preparation

Arc-fault-tested protective trousers - fluorescent orange, men's long sizes



General technical data:	
Arc fault protection class (box test 7 kA / 0.5 s - single-pole)	APC 2
Arc energy (W _{arc} or W _{LBP})	320 kJ
Arc rating - ATPV (open arc)	16 cal / cm ² *)
Arc rating - ELIM (open arc)	13 cal / cm ²
PPE category (NFPA 70E)	PPE 2
Weight per unit area	300 g/m ²
Primary colour	fluorescent orange
Secondary colour	grey
Zipper	red
Design code	TOORGRRE0000P0

Type	APT OD OG 90	APT OD OG 94
Part No.	787 870 <small>NEW</small>	787 871 <small>NEW</small>
Size (international)	90 (XS-L)	94 (S-L)

Type	APT OD OG 98	APT OD OG 102
Part No.	787 872 <small>NEW</small>	787 873 <small>NEW</small>
Size (international)	98 (M-L)	102 (M/L-L)

Type	APT OD OG 106	APT OD OG 110
Part No.	787 874 <small>NEW</small>	787 875 <small>NEW</small>
Size (international)	106 (L-L)	110 (XL-L)

Type	APT OD OG 114	APT OD OG 118
Part No.	787 876 <small>NEW</small>	787 877 <small>NEW</small>
Size (international)	114 (XL/2XL-L)	118 (2XL-L)

*) Outer fabric after preparation

Arc-fault-tested protective jacket - fluorescent orange, standard ladies' sizes



General technical data:	
Arc fault protection class (box test 7 kA / 0.5 s - single-pole)	APC 2
Arc energy (W _{arc} or W _{LBP})	320 kJ
Arc rating - ATPV (open arc)	16 cal / cm ² *)
Arc rating - ELIM (open arc)	13 cal / cm ²
PPE category (NFPA 70E)	PPE 2
Weight per unit area	300 g/m ²
Primary colour	fluorescent orange
Secondary colour	grey
Zipper	red
Design code	JOORGRRE0000P0000

Type	APJ OD OG F 34	APJ OD OG F 36
Part No.	787 830 NEW	787 831 NEW
Size (international)	34 (XS)	36 (S)

Type	APJ OD OG F 38	APJ OD OG F 40
Part No.	787 832 NEW	787 833 NEW
Size (international)	38 (M)	40 (M/L)

Type	APJ OD OG F 42	APJ OD OG F 44
Part No.	787 834 NEW	787 835 NEW
Size (international)	42 (L)	44 (XL)

Type	APJ OD OG F 46	APJ OD OG F 48
Part No.	787 836 NEW	787 837 NEW
Size (international)	46 (XL/2XL)	48 (2XL)

Type	APJ OD OG F 50	APJ OD OG F 52
Part No.	787 838 NEW	787 839 NEW
Size (international)	50 (2XL/3XL)	52 (3XL)

Type	APJ OD OG F 54	APJ OD OG F 56
Part No.	787 840 NEW	787 841 NEW
Size (international)	54 (3XL/4XL)	56 (4XL)

*) Outer fabric after preparation

Arc-fault-tested protective trousers - fluorescent orange, standard ladies' sizes



General technical data:	
Arc fault protection class (box test 7 kA / 0.5 s - single-pole)	APC 2
Arc energy (W _{arc} or W _{LBP})	320 kJ
Arc rating - ATPV (open arc)	16 cal / cm ² *)
Arc rating - ELIM (open arc)	13 cal / cm ²
PPE category (NFPA 70E)	PPE 2
Weight per unit area	300 g/m ²
Primary colour	fluorescent orange
Secondary colour	grey
Zipper	red
Design code	TOORGRRE0000P0

Type	APT OD OG F 34	APT OD OG F 36
Part No.	787 880 NEW	787 881 NEW
Size (international)	34 (XS)	36 (S)

Type	APT OD OG F 38	APT OD OG F 40
Part No.	787 882 NEW	787 883 NEW
Size (international)	38 (M)	40 (M/L)

Type	APT OD OG F 42	APT OD OG F 44
Part No.	787 884 NEW	787 885 NEW
Size (international)	42 (L)	44 (XL)

Type	APT OD OG F 46	APT OD OG F 48
Part No.	787 886 NEW	787 887 NEW
Size (international)	46 (XL/2XL)	48 (2XL)

Type	APT OD OG F 50	APT OD OG F 52
Part No.	787 888 NEW	787 889 NEW
Size (international)	50 (2XL/3XL)	52 (3XL)

Type	APT OD OG F 54	APT OD OG F 56
Part No.	787 890 NEW	787 891 NEW
Size (international)	54 (3XL/4XL)	56 (4XL)

*) Outer fabric after preparation

Arc-fault-tested protective jacket - configurable



Type	APJ OD KONFI
Part No.	785 359
Arc fault protection class (box test 7 kA / 0.5 s - single-pole)	APC 2
Arc energy (W _{arc} or W _{LBP})	320 kJ
Arc rating - ATPV (open arc)	16 cal / cm ² *)
Arc rating - ELIM (open arc)	13 cal / cm ²
PPE category (NFPA 70E)	PPE 2
Weight per unit area	300 g/m ²
Configurable:	
Primary colour	fluorescent yellow / fluorescent orange
Secondary colour	grey / black
Zipper	red / black
Logo	yes / no
Logo position (1-4)	chest right / stand-up collar left / stand-up collar back / back
Name	yes / no (max. 22 characters)
Size (international)	from 46 (XS) to 62 (3XL)
Design code / Attention: Please indicate the unique design code when ordering	

*) Outer fabric after preparation

Arc-fault-tested protective trousers - configurable



Type	APT OD KONFI
Part No.	785 369
Arc fault protection class (box test 7 kA / 0.5 s - single-pole)	APC 2
Arc energy (W _{arc} or W _{LBP})	320 kJ
Arc rating - ATPV (open arc)	16 cal / cm ² *)
Arc rating - ELIM (open arc)	13 cal / cm ²
PPE category (NFPA 70E)	PPE 2
Weight per unit area	300 g/m ²
Configurable:	
Primary colour	fluorescent yellow / fluorescent orange
Secondary colour	grey / black
Zipper	red / black
Logo	yes / no
Logo position (5)	Pocket left trouser leg
Size (international)	from 46 (XS) to 62 (3XL)
Design code / Attention: Please indicate the unique design code when ordering	

*) Outer fabric after preparation

Accessories for DEHNcare ArcFit Protective Trousers

Belt for APT ID / OD, flame-retardant



- Elastic

General technical data:

Colour	black
--------	-------

Type	APA B 80	APA B 90
Part No.	785 377	785 370
Length	80 cm	90 cm
- Men's standard sizes	42	44 + 46
- Men's short sizes	-	22 + 23
- Men's long sizes	-	90
- Ladies' standard sizes	34 + 36	38 + 40

Type	APA B 100	APA B 110
Part No.	785 371	785 372
Length	100 cm	110 cm
- Men's standard sizes	48 + 50	52 + 54
- Men's short sizes	24 + 25	26 + 27
- Men's long sizes	94 + 98	102 + 106
- Ladies' standard sizes	42 + 44	46 + 48

Type	APA B 120	APA B 130
Part No.	785 373	785 374
Length	120 cm	130 cm
- Men's standard sizes	56 + 58	60 + 62
- Men's short sizes	28 + 29	30
- Men's long sizes	110 + 114	118
- Ladies' standard sizes	50 + 52	54 + 56

Type	APA B 140	APA B 150
Part No.	785 375	785 376
Length	140 cm	150 cm
- Men's standard sizes	64 + 66	68
- Men's short sizes	-	-
- Men's long sizes	-	-
- Ladies' standard sizes	-	-

DEHNcare UnderWear



Increase the protection level of your PPE against arc faults with the new UnderWear.

A layered clothing principle increases the level of protection in conjunction with DEHNcare ArcFit.

- Bicolour polo shirt, arc fault protection class APC 1; high-visibility clothing class 1
- Certified according to PPE regulation (EU) 2016/425

General technical data:

Standard	IEC 61482-2, EN ISO 11612, EN 1149-5, EN ISO 20471
----------	--

Arc-fault-tested polo shirt, long-sleeved



General technical data:

Arc fault protection class (box test 4 kA/0.5 s - single-pole)	APC 1
Arc power (W_{arc} or W_{LBP})	168 kJ
Arc Rating - ATPV (Open Arc Test)	5.4 cal / cm ²
Material	Cotton (50%), modacrylic (39%), viscose (10%), static inhibitors (1%)
Weight per unit area	160 g/m ²
Colour	fluorescent yellow/blue
High-visibility clothing class	1

Type	APPS BC XS	APPS BC S
Part No.	787 001 <small>NEW</small>	787 002 <small>NEW</small>
Size (international)	XS	S

Type	APPS BC M	APPS BC L
Part No.	787 003 <small>NEW</small>	787 004 <small>NEW</small>
Size (international)	M	L

Type	APPS BC XL	APPS BC 2XL
Part No.	787 005 <small>NEW</small>	787 006 <small>NEW</small>
Size (international)	XL	2XL

Type	APPS BC 3XL	APPS BC 4XL
Part No.	787 007 <small>NEW</small>	787 008 <small>NEW</small>
Size (international)	3XL	4XL

Arc-fault-tested undershirt, long-sleeved



General technical data:

Arc fault protection class (box test 4 kA/0.5 s - single-pole)	APC 1	
Arc power (W_{arc} or W_{LBP})	168 kJ	
Arc Rating - ATPV (Open Arc Test)	4.1 cal / cm ²	
In combination with DEHNcare ArcFit Indoor	31 cal / cm ²	
In combination with DEHNcare ArcFit Outdoor	37 cal / cm ²	
Arc Rating - ELIM (in combination with DEHNcare ArcFit Indoor)	28 cal / cm ²	
Arc Rating - ELIM (in combination with DEHNcare ArcFit Outdoor)	34 cal / cm ²	
Material	Cotton (50%), modacrylic (39%), viscose (10%), static inhibitors (1%)	
Weight per unit area	160 g/m ²	
Colour	blue	

Type	APUS XS	APUS S
Part No.	787 011 <small>NEW</small>	787 012 <small>NEW</small>
Size (international)	XS	S

Type	APUS M	APUS L
Part No.	787 013 <small>NEW</small>	787 014 <small>NEW</small>
Size (international)	M	L

Type	APUS XL	APUS 2XL
Part No.	787 015 <small>NEW</small>	787 016 <small>NEW</small>
Size (international)	XL	2XL

Type	APUS 3XL	APUS 4XL
Part No.	787 017 <small>NEW</small>	787 018 <small>NEW</small>
Size (international)	3XL	4XL

Arc-fault-tested underpants



General technical data:

Arc fault protection class (box test 4 kA/0.5 s - single-pole)	APC 1	
Arc power (W_{arc} or W_{LBP})	168 kJ	
Arc Rating - ATPV (Open Arc Test)	4.1 cal / cm ²	
In combination with DEHNcare ArcFit Indoor	31 cal / cm ²	
In combination with DEHNcare ArcFit Outdoor	37 cal / cm ²	
Arc Rating - ELIM (in combination with DEHNcare ArcFit Indoor)	28 cal / cm ²	
Arc Rating - ELIM (in combination with DEHNcare ArcFit Outdoor)	34 cal / cm ²	
Material	Cotton (50%), modacrylic (39%), viscose (10%), static inhibitors (1%)	
Weight per unit area	160 g/m ²	
Colour	blue	

Type	APUP XS	APUP S
Part No.	787 021 <small>NEW</small>	787 022 <small>NEW</small>
Size (international)	XS	S

Type	APUP M	APUP L
Part No.	787 023 <small>NEW</small>	787 024 <small>NEW</small>
Size (international)	M	L

Type	APUP XL	APUP 2XL
Part No.	787 025 <small>NEW</small>	787 026 <small>NEW</small>
Size (international)	XL	2XL

Type	APUP 3XL	APUP 4XL
Part No.	787 027 <small>NEW</small>	787 028 <small>NEW</small>
Size (international)	3XL	4XL

DEHNcare ArcFit HLP 63



Personal protective clothing for work on electrical installations with higher energies.

- All-round protection with arc flash protection class APC 2 - PPE 4 as per NFPA 70E
- Even more safety for demanding work - APC 2 also with increased arc energy of 630 kJ (W_{arc} or W_{LBP})
- Environmentally friendly - washable up to 60°
- Certified according to PPE regulation (EU) 2016/425

General technical data:

Standard	IEC 61482-2, EN ISO 11612, EN 1149-5, EN ISO 13688, EN ISO 11611, EN 17353, ASTM F1959
Material - outer fabric	Modacrylic (46%), HT viscose (22%), FR viscose (18%), para-aramid (12%), static inhibitors (2%)
Material - lining / non-woven material	Lining: Aramid (34%), FR viscose (34%), Reg. viscose (32%) / non-woven material: FR viscose (85%), para-aramid (15%)
Material (sewing thread)	Kevlar (100%)

Arc-fault-tested protective jacket



General technical data:

Arc fault protection class (box test 7 kA / 0.5 s - single-pole)	APC 2	
Arc energy (W_{arc} or W_{LBP})	320 kJ	
Extended electric arc energy (W_{arc} or W_{LBP}) (based on box test)	630 kJ	
Arc Rating - ATPV (Open Arc)	63 cal / cm ²	
Arc Rating - ELIM (Open Arc)	58 cal / cm ²	
PPE category (NFPA 70E)	PPE 4	
Outer fabric weight per unit area	225 g / m ²	
Lining / non-woven material weight per unit area	430 g / m ²	
Colour	navy blue	
Zipper	red	

Type	APJ 63C S	APJ 63C M
Part No.	787 370 <small>NEW</small>	787 371 <small>NEW</small>
Size (international)	48 (S)	50/52 (M)

Type	APJ 63C L	APJ 63C XL
Part No.	787 372 <small>NEW</small>	787 373 <small>NEW</small>
Size (international)	52/54 (L)	56/58 (XL)

Type	APJ 63C 2XL	APJ 63C 3XL
Part No.	787 374 <small>NEW</small>	787 375 <small>NEW</small>
Size (international)	58/60 (2XL)	62/64 (3XL)

Type	APJ 63C 4XL
Part No.	787 376 <small>NEW</small>
Size (international)	64/66 (4XL)

Arc-fault-tested protective trousers (bib overall as over-trousers)



General technical data:	
Arc fault protection class (box test 7 kA / 0.5 s - single-pole)	APC 2
Arc energy (W_{arc} or W_{LBP})	320 kJ
Extended electric arc energy (W_{arc} or W_{LBP}) (based on box test)	630 kJ
Arc Rating - ATPV (Open Arc)	63 cal / cm ²
Arc Rating - ELIM (Open Arc)	58 cal / cm ²
PPE category (NFPA 70E)	PPE 4
Outer fabric weight per unit area	225 g / m ²
Lining / non-woven material weight per unit area	430 g / m ²
Colour	navy blue
Zipper	red

Type	APD 63C S	APD 63C M
Part No.	787 380 <small>NEW</small>	787 381 <small>NEW</small>
Size (international)	48 (S)	50/52 (M)

Type	APD 63C L	APD 63C XL
Part No.	787 382 <small>NEW</small>	787 383 <small>NEW</small>
Size (international)	52/54 (L)	56/58 (XL)

Type	APD 63C 2XL	APD 63C 3XL
Part No.	787 384 <small>NEW</small>	787 385 <small>NEW</small>
Size (international)	58/60 (2XL)	62/64 (3XL)

Type	APD 63C 4XL
Part No.	787 386 <small>NEW</small>
Size (international)	64/66 (4XL)

DEHNcare ArcClassic



The ArcClassic is ideal as protective equipment in transformer stations and switchgear installations for non-routine switching operations.

- Comfortable to wear due to the use of breathable leather and neoprene
- Flame-retardant zippers and hook-and-loop fasteners
- Reflective strips
- Certified according to PPE regulation (EU) 2016/425

General technical data:	
Standard	IEC 61482-2, EN ISO 14116
Outer material	Siliconised calf grain leather, 100% Kevlar® interlock knit
Inner material	100% cotton
Material (sewing thread)	100% Kevlar®



Jacket with reinforced stand-up collar and useful side arm pockets. Trousers with adjustable belt and useful leg pockets.

Arc-fault-tested protective coat

- Reinforced stand-up collar
- Useful side arm pockets
- Zip and hook-and-loop fasteners



General technical data:	
Arc fault protection class (box test 7 kA / 0.5 s - single-pole)	APC 2
Arc energy (W_{arc} or W_{LBP})	320 kJ
Extended electric arc energy (W_{arc} or W_{LBP}) (based on box test)	630 kJ
EuroTest PIP001 (10 kA / 1 s - three-pole)	Yes
Arc Rating - ATPV (Open Arc Test)	33.1 cal / cm ²
PPE category (NFPA 70E)	PPE 3

Type	APC 48 50	APC 52 54
Part No.	785 755	785 756
Size (international)	48 / 50 (M)	52 / 54 (L)

Type	APC 56 58	APC 60 62
Part No.	785 757	785 758
Size (international)	56 / 58 (XL)	60 / 62 (XXL)

Type	APC 64 66
Part No.	785 759
Size (international)	64 / 66 (3XL)

Arc-fault-tested protective jacket

- Reinforced stand-up collar
- Useful side arm pockets
- Zip and hook-and-loop fastener



General technical data:

Arc fault protection class (box test 7 kA / 0.5 s - single-pole)	APC 2	
Arc energy (W_{arc} or W_{LBP})	320 kJ	
Extended electric arc energy (W_{arc} or W_{LBP}) (based on box test)	630 kJ	
EuroTest PIP001 (10 kA / 1 s - three-pole)	Yes	
Arc Rating - ATPV (Open Arc Test)	33.1 cal / cm ²	
PPE category (NFPA 70E)	PPE 3	

Type	APJ 46	APJ 48
Part No.	785 769	785 770
Size (international)	46 (XS)	48 (S)

Type	APJ 50	APJ 52
Part No.	785 771	785 772
Size (international)	50 (M)	52 (L)

Type	APJ 54	APJ 56
Part No.	785 773	785 774
Size (international)	54 (XL)	56 (XXL)

Type	APJ 58
Part No.	785 775
Size (international)	58 (3XL)

Arc-fault-tested protective trousers

- Knee pads and pair of braces included
- Pockets for knee pads
- Adjustable belt



General technical data:

Arc fault protection class (box test 7 kA / 0.5 s - single-pole)	PC 2	
Arc energy (W_{arc} or W_{LBP})	320 kJ	
Extended electric arc energy (W_{arc} or W_{LBP}) (based on box test)	630 kJ	
Arc Rating - ATPV (Open Arc Test)	29.2 cal / cm ²	
PPE category (NFPA 70E)	PPE 3	

Type	APT 46	APT 48
Part No.	785 779	785 780
Size (international)	46 (XS)	48 (S)

Type	APT 50	APT 52
Part No.	785 781	785 782
Size (international)	50 (M)	52 (L)

Type	APT 54	APT 56
Part No.	785 783	785 784
Size (international)	54 (XL)	56 (XXL)

Type	APT 58
Part No.	785 785
Size (international)	58 (3XL)

In case of very heavy soiling, the protective trousers can be dry cleaned by a specialist leather cleaner.

Accessories for DEHNcare ArcClassic Protective Trousers

Pair of braces

For arc-fault-tested protective trousers with four hook-and-loop fasteners.



Type	APA B
Part No.	785 788
Colour	Black 1

Knee pads

For arc-fault-tested protective trousers, to be inserted into the lining of the trouser legs (slit pockets).



Type	APA KP
Part No.	785 789
Material	Foam

DEHNcare APG XT



Arc-fault-tested protective gloves of protection class APC 2 150 for working on electrical installations.

- First gloves on the German market which have obtained protection class APC 2 at 150 mm in accordance with the GS-ET 42-2 test principle.
- The wearing comfort previously offered through a tried-and-tested combination of leather and neoprene remains in place in the new model despite the greater protective effect
- The gauntlet length of 100 mm in the normal design (APG) has been lengthened to 140 mm in the APG XT
- Certified according to PPE regulation (EU) 2016/425

General technical data:

Standard	GS-ET 42-2, ASTM F2675, EN 388, EN 407
Material (glove palm)	Siliconised calf grain leather
Material (glove back)	100% Kevlar interlock knit
Material (sewing thread)	Kevlar

Arc-fault-tested protective glove, protection class: APC 2 150



General technical data:	
Arc fault protection class (box test 7 kA / 0.5 s - single-pole)	APC 2 150
Arc energy (W_{arc} or W_{LBP})	320 kJ
Arc Rating - ATPV (Open Arc Test)	40 cal / cm ²
PPE category (NFPA 70E)	PPE 4
Gauntlet length	140 mm

Type APG XT ...	7 APC 2 150	8 APC 2 150
Part No.	785 830 <small>NEW</small>	785 831 <small>NEW</small>
Total length	330 mm	335 mm
Size (international)	7 (S)	8 (M)

Type APG XT ...	9 APC 2 150	10 APC 2 150
Part No.	785 832 <small>NEW</small>	785 833 <small>NEW</small>
Total length	340 mm	350 mm
Size (international)	9 (L)	10 (XL)

Type APG XT ...	11 APC 2 150	12 APC 2 150
Part No.	785 834 <small>NEW</small>	785 835 <small>NEW</small>
Total length	355 mm	360 mm
Size (international)	11 (XXL)	12 (3XL)

Type APG XT ...	13 APC 2 150
Part No.	785 836 <small>NEW</small>
Total length	365 mm
Size (international)	13 (4XL)

Arc-fault-tested protective gloves with long gauntlet, protection class: APC 2 150



General technical data:	
Arc fault protection class (box test 7 kA / 0.5 s - single-pole)	APC 2 150
Arc energy (W_{arc} or W_{LBP})	320 kJ
Arc Rating - ATPV (Open Arc Test)	40 cal / cm ²
PPE category (NFPA 70E)	PPE 4
Gauntlet length	230 mm

Type APG XT ...	7 L APC 2 150	8 L APC 2 150
Part No.	785 840 <small>NEW</small>	785 841 <small>NEW</small>
Total length	410 mm	420 mm
Size (international)	7 (S)	8 (M)

Type APG XT ...	9 L APC 2 150	10 L APC 2 150
Part No.	785 842 <small>NEW</small>	785 843 <small>NEW</small>
Total length	430 mm	435 mm
Size (international)	9 (L)	10 (XL)

Type APG XT ...	11 L APC 2 150	12 L APC 2 150
Part No.	785 844 <small>NEW</small>	785 845 <small>NEW</small>
Total length	440 mm	445 mm
Size (international)	11 (XXL)	12 (3XL)

Type APG XT ...	13 L APC 2 150
Part No.	785 846 <small>NEW</small>
Total length	450 mm
Size (international)	13 (4XL)

Arc-fault-tested protective glove, protection class: APC 1 150



General technical data:	
Arc fault protection class (box test 4 kA / 0.5 s - single-pole)	APC 1 150
Arc energy (W_{arc} or W_{LBP})	168 kJ
Arc Rating - ATPV (Open Arc Test)	35 cal / cm ²
PPE category (NFPA 70E)	PPE 3
Gauntlet length	140 mm

Type APG XT ...	7 APC 1 150	8 APC 1 150
Part No.	785 850	785 851 <small>NEW</small>
Total length	330 mm	335 mm
Size (international)	7 (S)	8 (M)

Type APG XT ...	9 APC 1 150	10 APC 1 150
Part No.	785 852 <small>NEW</small>	785 853 <small>NEW</small>
Total length	340 mm	350 mm
Size (international)	9 (L)	10 (XL)

Type APG XT ...	11 APC 1 150	12 APC 1 150
Part No.	785 854 <small>NEW</small>	785 855 <small>NEW</small>
Total length	355 mm	360 mm
Size (international)	11 (XXL)	12 (3XL)

Type APG XT ...	13 APC 1 150
Part No.	785 856 <small>NEW</small>
Total length	365 mm
Size (international)	13 (4XL)

Arc-fault-tested protective gloves with long gauntlet, protection class: APC 1 150



General technical data:	
Arc fault protection class (box test 4 kA / 0.5 s - single-pole)	APC 1 150
Arc energy (W_{arc} or W_{LBP})	168 kJ
Arc Rating - ATPV (Open Arc Test)	35 cal / cm ²
PPE category (NFPA 70E)	PPE 3
Gauntlet length	230 mm

Type APG XT ...	7 L APC 1 150	8 L APC 1 150
Part No.	785 860 <small>NEW</small>	785 861 <small>NEW</small>
Total length	410 mm	420 mm
Size (international)	7 (S)	8 (M)

Type APG XT ...	9 L APC 1 150	10 L APC 1 150
Part No.	785 862 <small>NEW</small>	785 863 <small>NEW</small>
Total length	430 mm	435 mm
Size (international)	9 (L)	10 (XL)

Type APG XT ...	11 L APC 1 150	12 L APC 1 150
Part No.	785 864 <small>NEW</small>	785 865 <small>NEW</small>
Total length	440 mm	445 mm
Size (international)	11 (XXL)	12 (3XL)

Type APG XT ...	13 L APC 1 150
Part No.	785 866 <small>NEW</small>
Total length	450 mm
Size (international)	13 (4XL)

DEHNcare APG



Arc-fault-tested protective gloves for working on electrical installations.

- For protection against thermal and mechanical risks
- Excellent fit due to special glove cut
- Good touch sensitivity due to soft leather inner surface of the gloves
- Comfortable to wear due to the use of breathable materials
- Certified according to PPE regulation (EU) 2016/425

General technical data:

Standard	IEC 61482-1-2; IEC 61482-1-1; EN 388, EN 407
Material (glove palm)	Siliconised calf grain leather
Material (glove back)	100% Kevlar® interlock knit
Material (sewing thread)	Kevlar®

Arc-fault-tested protective gloves



General technical data:

Arc fault protection class (box test 7 kA / 0.5 s - single-pole)	APC 2
Arc energy (W_{arc} or W_{LBP})	320 kJ
Arc Rating - ATPV (Open Arc Test)	32.8 cal / cm ²
PPE category (NFPA 70E)	PPE 3
Gauntlet length	115 mm

Type APG ...	8	9
Part No.	785 796	785 797
Total length	310 mm	315 mm
Size (international)	8 (M)	9 (L)

Type APG ...	10	11
Part No.	785 798	785 799
Total length	325 mm	330 mm
Size (international)	10 (XL)	11 (XXL)

Type APG ...	12
Part No.	785 800
Total length	335 mm
Size (international)	12 (3XL)

Arc-fault-tested protective gloves with long gauntlet



General technical data:

Arc fault protection class (box test 7 kA / 0.5 s - single-pole)	APC 2
Arc energy (W_{arc} or W_{LBP})	320 kJ
Arc Rating - ATPV (Open Arc Test)	32.8 cal / cm ²
PPE category (NFPA 70E)	PPE 3
Gauntlet length	250 mm

Type APG ...	8 L	9 L
Part No.	785 808	785 809
Total length	440 mm	450 mm
Size (international)	8 (M)	9 (L)

Type APG ...	10 L	11 L
Part No.	785 810	785 811
Total length	455 mm	460 mm
Size (international)	10 (XL)	11 (XXL)

Type APG ...	12 L
Part No.	785 812
Total length	465 mm
Size (international)	12 (3XL)

Insulating gloves up to 1000 V



Work on an electric vehicle with insulating gloves.

- For working on live parts
- The gloves provide an excellent fit and high elasticity with maximum insulating capacity
- Different designs available to suit your needs
- Certified according to PPE regulation (EU) 2016/425

General technical data:

Standard (gloves)	EN 60903
Standard (NH fuse handle)	VDE 0680-4; GS-ET-38

NH Fuse Handle with Sleeve

For actuating NH fuses of sizes 00, 1, 2 and 3



Type	NHS AG 00 3 NS
Part No.	785 645
Nominal voltage up to (U_N)	1000 V
Colour	Beige 1
Material	Coated cotton fabric

Insulating gloves, category AZC Acid, ozone and cold-resistant



General technical data:

Colour	red
Total length	360 mm
Material	Natural rubber

Type	KL-A-8-36-S	KL-A-9-36-S
Part No.	787 480	787 481
Class	00	00
Nominal voltage up to (U _N)	500 V	500 V
Thickness	0.5 mm	0.5 mm
Size	8	9

Type	KL-A-10-36-S	KL-A-11-36-S
Part No.	787 482	787 483
Class	00	00
Nominal voltage up to (U _N)	500 V	500 V
Thickness	0.5 mm	0.5 mm
Size	10	11

Type	KL-B-8-36-S	KL-B-9-36-S
Part No.	787 484	787 485
Class	0	0
Nominal voltage up to (U _N)	1000 V	1000 V
Thickness	1.0 mm	1.0 mm
Size	8	9

Type	KL-B-10-36-S	KL-B-11-36-S
Part No.	787 486	787 487
Class	0	0
Nominal voltage up to (U _N)	1000 V	1000 V
Thickness	1.0 mm	1.0 mm
Size	10	11

Insulating gloves, category RC, arc-fault-tested to protection class APC 2



General technical data:

Class	0
Nominal voltage up to (U _N)	1000 V
Arc fault protection class (box test 7 kA / 0.5 s - single-pole)	APC 2
Colour	red
Thickness	1.0 mm
Total length	360 mm
Material	Natural latex

Type	CG-10/S2 A R 8	CG-10/S2 B R 9
Part No.	785 381	785 382
Size	8	9

Type	CG-10/S2 C R 10	CG-10/S2 D R 11
Part No.	785 383	785 384
Size	10	11

Insulating gloves, category RC Resistant against acids, ozone and oil, as well as extremely low temperatures



General technical data:

Colour	black
Total length	360 mm
Material	Natural rubber

Type	KC-AI-8-36-S	KC-AI-9-36-S
Part No.	787 490	787 491
Class	00	00
Nominal voltage up to (U _N)	500 V	500 V
Thickness	1.8 mm	1.8 mm
Size	8	9

Arc rating in accordance with ASTM F2675	14 cal / cm ²	14 cal / cm ²
--	--------------------------	--------------------------

Type	KC-AI-10-36-S	KC-AI-11-36-S
Part No.	787 492	787 493
Class	00	00
Nominal voltage up to (U _N)	500 V	500 V
Thickness	1.8 mm	1.8 mm
Size	10	11

Arc rating in accordance with ASTM F2675	14 cal / cm ²	14 cal / cm ²
--	--------------------------	--------------------------

Type	KC-BI-8-36-S	KC-BI-9-36-S
Part No.	787 494	787 495
Class	0	0
Nominal voltage up to (U _N)	1000 V	1000 V
Thickness	2.3 mm	2.3 mm
Size	8	9

Arc rating in accordance with ASTM F2675	25 cal / cm ²	25 cal / cm ²
--	--------------------------	--------------------------

Type	KC-BI-10-36-S	KC-BI-11-36-S
Part No.	787 496	787 497
Class	0	0
Nominal voltage up to (U _N)	1000 V	1000 V
Thickness	2.3 mm	2.3 mm
Size	10	11

Arc rating in accordance with ASTM F2675	25 cal / cm ²	25 cal / cm ²
--	--------------------------	--------------------------

Accessories for Insulating gloves up to 1000 V

Pneumatic glove tester

Suitable for the periodic inspection pursuant to EN 60903.



Type	VPG90
Part No.	787 000
Colour	Grey ●

Storage bag, empty



Type	AT IHS NS
Part No.	785 490
Dimensions	400 x 180 x 50 mm
Colour	Brown ●

Insulating gloves up to 36 kV



Work on live parts with insulating gloves.

- For live working up to 36 kV AC
- Category RC = Resistant against acids, ozone and oil, as well as extremely low temperatures
- Certified according to PPE regulation (EU) 2016/425

General technical data:

Standard EN 60903

Insulating gloves - class 1

Resistant against acids, ozone and oil, as well as extremely low temperatures



General technical data:

Max. operating voltage	7.5 kV
Test voltage	10 kV
Total length	360 mm
Packaging colour	white

Type	KL-C-8-41-S	KL-C-9-41-S
Part No.	787 100 NEW	787 101 NEW
Size	8	9

Type	KL-C-10-41-S	KL-C-11-41-S
Part No.	787 102 NEW	787 103 NEW
Size	10	11

Insulating gloves - class 2

Resistant against acids, ozone and oil, as well as extremely low temperatures



General technical data:

Max. operating voltage	17 kV
Test voltage	20 kV
Total length	410 mm
Packaging colour	white / yellow

Type	KL-D-8-41-S	KL-D-9-41-S
Part No.	787 104 NEW	787 105 NEW
Size	8	9

Type	KL-D-10-41-S	KL-D-11-41-S
Part No.	787 106 NEW	787 107 NEW
Size	10	11

Insulating gloves - class 3

Resistant against acids, ozone and oil, as well as extremely low temperatures



General technical data:

Max. operating voltage	26.5 kV
Test voltage	30 kV
Total length	410 mm
Packaging colour	white / green

Type	KL-E-8-41-S	KL-E-9-41-S
Part No.	787 108 NEW	787 109 NEW
Size	8	9

Type	KL-E-10-41-S	KL-E-11-41-S
Part No.	787 110 NEW	787 111 NEW
Size	10	11

Insulating gloves - class 4

Resistant against acids, ozone and oil, as well as extremely low temperatures



General technical data:

Max. operating voltage	36 kV
Test voltage	40 kV
Total length	410 mm
Packaging colour	white / green

Type	KL-F-9-41-S	KL-F-10-41-S
Part No.	787 112 NEW	787 113 NEW
Size	9	10

Type	KL-F-11-41-S
Part No.	787 114 NEW
Size	11

Zubehör für Isolierende Handschuhe 1000 V bis 36 kV

Pneumatischer Handschuhprüfer

Geeignet für die wiederkehrende Prüfung gemäß der EN 60903.



Type	VPG90
Part No.	787 000
Farbe	grau ●

Storage bag, empty



Type	AT IHS NS
Part No.	785 490
Dimensions	400 x 180 x 50 mm
Colour	Brown ●

Safety shoes with insulating soles up to 1000 V



Safety shoes are an important part of personal protective equipment.

- Safety shoes and boots for electricians
- Insulating outsole for up to 1,000 V
- Certified according to PPE regulation (EU) 2016/425

General technical data:	
Standard	EN ISO 20345:2011
Material	Leather
Lining	Textile
Classification as per EN ISO 20345:2011	Class I
Protection class as per EN ISO 20345:2011	SB
Protective cap	Plastic
Sealed with	Shoelaces
Sole type	Polyurethane
Penetration protection	Composite textile material
Metal-free equipment	Yes
Colour	Black / orange
Application	Electrical engineering
Special properties: The outsole provides electrical insulation at voltages up to 1,000 V - MΩ > 1,000 if requirements are met (no moisture, does not refer to the upper shaft).	
Electrical resistance acc. Canadian standard CSA Z 195 14 Increase by 1 kV/sec - Voltage 20,000 V / 60 Hz duration of 1 minute. Electrical resistance acc. the ASTM 2413-11 standard increase of 1 kV/sec - Voltage 20,000 V / 60 Hz duration of 1 minute. Requirement of electric flow lower than 1.0 mA.	

Low shoe, type FLOW
Shoe shape A



Type	FLOW SB FO E P CI WRU SRC 36	FLOW SB FO E P CI WRU SRC 37
Part No.	787 200 NEW	787 201 NEW
Size	36	37

Type	FLOW SB FO E P CI WRU SRC 38	FLOW SB FO E P CI WRU SRC 39
Part No.	787 202 NEW	787 203 NEW
Size	38	39

Type	FLOW SB FO E P CI WRU SRC 40	FLOW SB FO E P CI WRU SRC 41
Part No.	787 204 NEW	787 205 NEW
Size	40	41

Type	FLOW SB FO E P CI WRU SRC 42	FLOW SB FO E P CI WRU SRC 43
Part No.	787 206 NEW	787 207 NEW
Size	42	43

Type	FLOW SB FO E P CI WRU SRC 44	FLOW SB FO E P CI WRU SRC 45
Part No.	787 208 NEW	787 209 NEW
Size	44	45

Type	FLOW SB FO E P CI WRU SRC 46	FLOW SB FO E P CI WRU SRC 47
Part No.	787 210 NEW	787 211 NEW
Size	46	47

Laced boots, type LIGHT
Shoe shape B



Type	LIGHT SB FO E P CI WRU SRC 36	LIGHT SB FO E P CI WRU SRC 37
Part No.	787 220 NEW	787 221 NEW
Size	36	37

Type	LIGHT SB FO E P CI WRU SRC 38	LIGHT SB FO E P CI WRU SRC 39
Part No.	787 222 NEW	787 223 NEW
Size	38	39

Type	LIGHT SB FO E P CI WRU SRC 40	LIGHT SB FO E P CI WRU SRC 41
Part No.	787 224 NEW	787 225 NEW
Size	40	41

Type	LIGHT SB FO E P CI WRU SRC 42	LIGHT SB FO E P CI WRU SRC 43
Part No.	787 226 NEW	787 227 NEW
Size	42	43

Type	LIGHT SB FO E P CI WRU SRC 44	LIGHT SB FO E P CI WRU SRC 45
Part No.	787 228 NEW	787 229 NEW
Size	44	45

Type	LIGHT SB FO E P CI WRU SRC 46	LIGHT SB FO E P CI WRU SRC 47
Part No.	787 230 NEW	787 231 NEW
Size	46	47

DEHNcare APS with Active Protection



Arc-fault-tested face shield with additional illumination.

- Active protection (darkening) in case of an arc fault
- Best visual perception due to ergonomic chin protection
- Anti-mist coating
- Full protection even with scratches
- Service life of 10 years
- Certified according to PPE regulation (EU) 2016/425

General technical data:

Standard	GS-ET-29, EN 166, EN 147
----------	--------------------------

Arc-fault-tested face shield with tensioning strap



- Suitable for all standard safety helmets for electricians
- With slot on both sides for LED face shield light

General technical data:

Material	Polycarbonate	
Thickness	1.5 mm	
Arc fault protection class (box test 7 kA / 0.5 s - single-pole)	APC 2	
Arc energy (W_{arc} or W_{LBP})	318 kJ	

Type APS T AS ...	CL2 FS	14C FS
Part No.	785 824	785 825
Colour	Transparent	Light grey
Arc Rating - ATPV (Open Arc Test)	-	14 cal / cm ²
Visible light transmittance (VLT)	74.4 ... 100 %	43.2 ... 58.1 %
Light transmittance class	0	2

Type APS T AS ...	25C FS
Part No.	785 826
Colour	Grey
Arc Rating - ATPV (Open Arc Test)	25 cal / cm ²
Visible light transmittance (VLT)	43.2 ... 58.1 %
Light transmittance class	2

Arc-fault-tested face shield with clip



- Fits the slot in the ESH U S safety helmet for electricians
- With slot on both sides for LED face shield light

General technical data:

Material	Polycarbonate	
Thickness	1.5 mm	
Arc fault protection class (box test 7 kA / 0.5 s - single-pole)	APC 2	
Arc energy (W_{arc} or W_{LBP})	318 kJ	

Type APS T AS ...	CL2 SC	14C SC
Part No.	785 821	785 822
Colour	Transparent	Light grey
Arc Rating - ATPV (Open Arc Test)	-	14 cal / cm ²
Visible light transmittance (VLT)	74.4 ... 100 %	43.2 ... 58.1 %
Light transmittance class	0	2

Type APS T AS ...	25C SC
Part No.	785 823
Colour	Grey
Arc Rating - ATPV (Open Arc Test)	25 cal / cm ²
Visible light transmittance (VLT)	43.2 ... 58.1 %
Light transmittance class	2

Accessories for DEHNcare APS with Active Protection

LED face shield lamp

Suitable for slots on DEHNcare APS T AS face shields ...

Note: Battery not included!



Type	LED APS T AS
Part No.	785 829
Degree of protection	IPX4
Max. luminous flux	60 lumen

Accessories for DEHNcare APS with Active Protection

Visor holder with clip

For arc-fault-tested face shields with clip; APS T AS CL2 SC / APS T AS 14C SC / APS T AS 25C SC.



Type	VH SC APS T AS
Part No.	785 820
Material	Nylon
Colour	Red

Visor holder with strap

For arc-fault-tested face shields with strap; APS T AS CL2 FS / APS T AS 14C FS / APS T AS 25C FS.



Type	VH FS APS T AS
Part No.	785 827
Material	Nylon
Colour	Red

Microfibre bag

For cleaning and storing the DEHNcare APS face shields.



Type	MFB APS
Part No.	785 724
Suitable for	DEHNcare APS
Dimension	450 x 400 mm
Colour	black ●

Spare parts for visor holder with clip

Spare part for visor holders with clips consisting of two clips (left and right), including fixing bolts.



Type	R KIT APS ... SC
Part No.	785 828
Material	Plastic

Balaclava



The protection level is increased by wearing a balaclava.

- Increases the protective effect in combination with the face shield DEHNcare APS T AS ...
- Large face opening
- Large collar protects the neck
- Certified according to PPE regulation (EU) 2016/425

General technical data:

Standard	EN ISO 13688, EN ISO 11612, EN 61482-1-2
----------	--

DEHNcare APS with headgear



Face shield can be worn without additional helmet.

- Face shield with headgear for protection against the mechanical and thermal hazards of an electric arc during live working or when in close proximity to live parts.
- Arcing class APC 1
- Certified according to PPE regulation (EU) 2016/425

General technical data:

Standard	GS-ET 29, EN 166
----------	------------------

Arc-fault-tested balaclava



Type	APB APC2 29C
Part No.	785 790 <small>NEW</small>
Material	Modacrylic (55%), cotton (45%)
Arc fault protection class (box test 7 kA / 0.5 s - single-pole)	APC 2 *)
Arc energy (W _{arc} or W _{LBP})	320 kJ
Arc Rating - ATPV (Open Arc Test)	29 cal / cm ²
PPE category (NFPA 70E)	PPE 3
Colour	navy blue
Size (international)	One size

*) Outer fabric after preparation

Arc-fault-tested face shield with headgear



Type	APS ARC E1 SK7
Part No.	785 870 <small>NEW</small>
Nominal voltage up to (U _N)	1000 V
Colour	Transparent
Material	Polycarbonate
Wall thickness	approx. 2 mm
Arc fault protection class (box test 4 kA / 0.5 s - single-pole)	APC 1
Arc energy (W _{arc} or W _{LBP})	168 kJ

Accessories for DEHNcare APS with headgear

Microfibre bag

For cleaning and storing the DEHNcare APS face shields.



Type	MFB APS
Part No.	785 724
Suitable for	DEHNcare APS
Dimension	450 x 400 mm
Colour	black ●

DEHNcare APS with Lever



Fitter wearing protective equipment for charging post maintenance.

- Fog-free on the inside
- Extremely scratch-resistant
- Chemical-resistant on the outside
- Certified according to PPE regulation (EU) 2016/425

General technical data:

Standard	GS-ET-29, EN 166, EN 170
----------	--------------------------

Arc-fault-tested Face Shield with mechanical Lever



Type APS ...	CL1 MEHA
Part No.	785 721
Nominal voltage up to (U _N)	1000 V
Colour	Transparent
Material	Polycarbonate
Wall thickness	approx. 2 mm
Arc fault protection class (box test 4 kA / 0.5 s - single-pole)	APC 1
Arc energy (W _{arc} or W _{LBP})	158 kJ
Visible light transmittance (VLT)	≥ 75 %

Arc-fault-tested Face Shield with magnetic Lever



Type APS ...	CL2 MAHA
Part No.	785 722
Nominal voltage up to (U _N)	1000 V
Colour	blue
Material	polycarbonate
Wall thickness	approx. 2 mm
Arc fault protection class (box test 7 kA / 0.5 s - single-pole)	APC 2
Arc energy (W _{arc} or W _{LBP})	318 kJ
Visible light transmittance (VLT)	≥ 74.4 %

Accessories for DEHNcare APS with Lever

Microfibre bag

For cleaning and storing the DEHNcare APS face shields.



Type	MFB APS
Part No.	785 724
Suitable for	DEHNcare APS
Dimension	450 x 400 mm
Colour	black ●

DEHNcare APHO



An arc-fault-tested protective hood must be worn, depending on the work environment.

- Frontal protection in case of direct incident energy from switchgear (zone 1 = heat shield)
- Secondary protection in case of indirect incident energy, e.g. in case of energy reflection from the side and from the back (zone 2 = all-round protection)
- Protection against parts flying around or falling down (zone 3)
- Certified according to PPE regulation (EU) 2016/425

General technical data:

Standard	GS-ET-29; IEC 61482-1-2; IEC 61482-1-1, EN 166, EN 170
----------	--

Arc-fault-tested Protective Hood

Note: Safety helmet for electricians ESH U S is not included in delivery!



Type	APHO
Part No.	785 760
Material	plastic, neoprene, leather
Arc fault protection class (box test 7 kA / 0.5 s - single-pole)	APC 2
Arc energy (W _{arc} or W _{LBP})	320 kJ
Arc Rating - ATPV (Open Arc Test)	37.2 cal / cm ²
PPE category (NFPA 70E)	PPE 3
Visible light transmittance (VLT)	29.1 ... 43.2 %

ESH U S Safety Helmet for Electricians



Monteur mit notwendiger Schutzausrüstung.

- With slot for APS ... SC face shield
- Adjustable to head sizes from 52 to 61 cm via push / rotary knob
- Six-point suspension with sweatband
- Certified according to PPE regulation (EU) 2016/425

General technical data:	
Standard	EN 50365, EN 397

ESH U S
Safety helmet with short peak



General technical data:	
Nominal voltage up to (U _N)	1000 V
Material	HDPE plastics

Type ESH U 1000 S ...	SY	SW
Part No.	785 705	785 706
Colour	Yellow ●	White ○

Type ESH U 1000 S ...	SO	SB
Part No.	785 707	785 708
Colour	Orange ●	Blue ●

Type ESH U 1000 S ...	SR
Part No.	785 709
Colour	Red ●

Accessories for ESH U S Safety Helmet for Electricians

Chin strap

For safety helmets for electricians ESH U S 1000, adjustable.



Type	KR ESH U 1000
Part No.	785 738
Colour	Black ●

Sweat band

For replacement on the ESH U S safety helmet for electricians



Type	SB ESH U 1000
Part No.	785 739
Material	Hydro-flock (S31F) PVC (S31P)
PU	10 pc(s).

LED head torch

- Fits the slot of the ESH US safety helmet for electricians, in connection with face shield APS CL1 MEHA and APS CL2 MAHA
- With two separate reflectors for distance and area lighting, with 4 switching steps
- Two charging options: micro USB or charging cradle. Charging unit with with charging cradle included in delivery



Type	LED HL ESH
Part No.	785 723
Degree of protection	IP 67
Light current max.	115 lumens

DEHNcare PPE sets - Indoor and Outdoor



To have everything you need for working on electrical systems, simply grab your bag.

- Various sets for indoor and outdoor use
- Available in different sizes
- Components comply with arc fault protection class 2 (APC 2)
- Protective equipment is certified according to PPE regulation (EU) 2016/425

Indoor - configurable

For the configurable indoor electrician set, the DEHNcare ArcFit is only available in the standard colours grey/black. The helmet colour and sizes are freely selectable.



Type PSA ESET ...	KONFI ID
Part No.	785 960 <small>NEW</small>
Protective jacket/trousers	
Men's standard sizes:	42 (2XS) - 68 (4XL/5XL)
Men's short sizes:	22 (2XS/XS-K) - 30 (2XL-K)
Men's long sizes:	90 (XS-L) - 118 (2XL-L)
Ladies' standard sizes:	34 (XS) - 56 (4XL)
Arc fault protection class (box test 7 kA / 0.5 s - single-pole)	APC 2
Arc energy (W _{arc} or W _{LBP})	320 kJ
Protective gloves 7 (S) / 8 (M) / 9 (L) / 10 (XL) / 11 (XXL) / 12 (3XL) / 13 (4XL)	
Arc fault protection class (box test 7 kA / 0.5 s - single-pole)	APC 2
Arc energy (W _{arc} or W _{LBP})	320 kJ
Arc Rating - ATPV (Open Arc Test)	40 cal / cm ²
PPE category (NFPA 70E)	4
Face shield transparent	
Arc fault protection class (box test 7 kA / 0.5 s - single-pole)	APC 2
Arc energy (W _{arc} or W _{LBP})	318 kJ
Visible light transmittance (VLT)	74.4 to 100%
Light transmittance class	0
Safety helmet for electricians yellow / white / orange / blue / red	
Nominal voltage up to (U _N)	1000 V
Belt	80 / 90 / 100 / 110 / 120 / 130 / 140 / 150 cm
Microfibre bag	450 x 400 mm
Storage rucksack	650 x 400 mm

Indoor

For the indoor electrician set, the DEHNcare ArcFit is only available in the standard colours grey/black.



General technical data:	
Protective jacket/trousers	
Arc fault protection class (box test 7 kA / 0.5 s - single-pole)	APC 2
Arc energy (W _{arc} or W _{LBP})	320 kJ
Protective gloves	
Arc fault protection class (box test 7 kA / 0.5 s - single-pole)	APC 2
Arc energy (W _{arc} or W _{LBP})	320 kJ
Arc Rating - ATPV (Open Arc Test)	32.8 cal / cm ²
PPE category (NFPA 70E)	PPE 3
Face shield transparent	
Arc fault protection class (box test 7 kA / 0.5 s - single-pole)	APC 2
Arc energy (W _{arc} or W _{LBP})	318 kJ
Visible light transmittance (VLT)	74.4 ... 100 %
Light transmittance class	0
Safety helmet for electricians yellow	
Nominal voltage up to (U _N)	1000 V
Microfibre bag	450 x 400 mm
Storage bag	Ø300, 500 mm

Type PSA ESET ...	S ID	M ID
Part No.	785 906 <small>NEW</small>	785 900 <small>NEW</small>
Protective jacket/trousers	48 (S)	50 (M)
Protective gloves	9 (L)	10 (XL)
Belt	100 cm	110 cm

Type PSA ESET ...	L ID	XL ID
Part No.	785 901 <small>NEW</small>	785 902 <small>NEW</small>
Protective jacket/trousers	54 (L)	56 (XL)
Protective gloves	10 (XL)	10 (XL)
Belt	110 cm	120 cm

Type PSA ESET ...	2XL ID
Part No.	785 907 <small>NEW</small>
Protective jacket/trousers	60 (2XL)
Protective gloves	11 (XXL)
Belt	130 cm

Outdoor

For the outdoor electrician set, the DEHNcare ArcFit is only available in the standard colours yellow/grey.



General technical data:	
Protective jacket/trousers	
Arc fault protection class (box test 7 kA / 0.5 s - single-pole)	APC 2
Arc energy (W _{arc} or W _{LBP})	320 kJ
Protective gloves	
Arc fault protection class (box test 7 kA / 0.5 s - single-pole)	APC 2
Arc energy (W _{arc} or W _{LBP})	320 kJ
Arc Rating - ATPV (Open Arc Test)	32.8 cal / cm ²
PPE category (NFPA 70E)	PPE 3
Face shield transparent	
Arc fault protection class (box test 7 kA / 0.5 s - single-pole)	APC 2
Arc energy (W _{arc} or W _{LBP})	318 kJ
Visible light transmittance (VLT)	74.4 ... 100 %
Light transmittance class	0
Safety helmet for electricians yellow	
Nominal voltage up to (U _N)	1000 V
Microfibre bag	450 x 400 mm
Storage bag	Ø300, 500 mm

Type PSA ESET ...	S OD	M OD
Part No.	785 908 <small>NEW</small>	785 903 <small>NEW</small>
Protective jacket/trousers	48 (S)	50 (M)
Protective gloves	9 (L)	10 (XL)
Belt	100 cm	110 cm

Type PSA ESET ...	L OD	XL OD
Part No.	785 904 <small>NEW</small>	785 905 <small>NEW</small>
Protective jacket/trousers	54 (L)	56 (XL)
Protective gloves	10 (XL)	10 (XL)
Belt	110 cm	120 cm

Type PSA ESET ...	2XL OD
Part No.	785 909 <small>NEW</small>
Protective jacket/trousers	60 (2XL)
Protective gloves	11 (XXL)
Belt	130 cm

Outdoor - configurable

For the configurable outdoor electrician set, the DEHNcare ArcFit is only available in the standard colours yellow/grey. The helmet colour and sizes are freely selectable.



Type PSA ESET ...	KONFI OD YE
Part No.	785 961 <small>NEW</small>
Protective jacket/trousers	
Men's standard sizes:	42 (2XS) - 68 (4XL/5XL),
Men's short sizes:	22 (2XS/XS-K) - 30 (2XL-K),
Men's long sizes:	90 (XS-L) - 118 (2XL-L),
Ladies' standard sizes:	34 (XS) - 56 (4XL)
Arc fault protection class (box test 7 kA / 0.5 s - single-pole)	APC 2
Arc energy (W _{arc} or W _{LBP})	320 kJ
Protective gloves 7 (S) / 8 (M) / 9 (L) / 10 (XL) / 11 (XXL) / 12 (3XL) / 13 (4XL)	
Arc fault protection class (box test 7 kA / 0.5 s - single-pole)	APC 2
Arc energy (W _{arc} or W _{LBP})	320 kJ
Arc Rating - ATPV (Open Arc Test)	40 cal / cm ²
PPE category (NFPA 70E)	4
Face shield transparent	
Arc fault protection class (box test 7 kA / 0.5 s - single-pole)	APC 2
Arc energy (W _{arc} or W _{LBP})	318 kJ
Visible light transmittance (VLT)	74.4 to 100%
Light transmittance class	0
Safety helmet for electricians yellow / white / orange / blue / red	
Nominal voltage up to (U _N)	1000 V
Belt	80 / 90 / 100 / 110 / 120 / 130 / 140 / 150 cm
Microfibre bag	450 x 400 mm
Storage rucksack	650 x 400 mm

Plastic Bag / Rucksack

For DEHNcare protective equipment.

Storage Bag

With side handle, carrying strap and string.



Type	AT 50 30
Part No.	785 442
Suitable for	ESH U + DEHNcare APS and APG
Dimensions	Ø300, 500 mm
Colour	Red ●

Storage Rucksack

With carrying straps and side net pocket with string.



Type	ARS 65 40
Part No.	785 443
Suitable for	DEHNcare protective equipment
Dimensions	650 x 400 mm
Colour	Red ●

Microfibre Bag

For cleaning and keeping of face shields DEHNcare APS.



Type	MFB APS
Part No.	785 724
Suitable for	DEHNcare APS
Dimensions	450 x 400 mm
Colour	Black ●



High-pressure resistant.
Water-repellent.
Comfortable.

A lot of people think "it's only water". True, but at high pressure, water can have devastating consequences for employees who use high-pressure water jets to clean surfaces and equipment.

From 250 bar, you definitely need more than just basic protection against moisture (DGUV 100-500). This is because water jets emitted at high pressure have a dangerous cutting effect. Serious and even fatal injuries can result if the body is hit unprotected.

The DEHNcare WJP protective clothing protects your employees during high-pressure cleaning with water jets up to 1000 bar.

Reliable protection when working with high-pressure water jets up to 1000 bar

Working with high-pressure water jets, represents a special hazard for workers. To prevent accidents caused by the enormous penetrating power of the water, DEHN has developed a protective overall made of a special material mix.

Extra protection for vulnerable parts of the body

In addition to the proven DEHNcare WJP Advanced protective overall, further WJP protective clothing components to protect those parts of the body that are particularly exposed to high-pressure water jets are now available.

Branding Service

3 good reasons for branding your protective overalls:

- Build brand awareness by displaying your logo and company name on the protective overall.
- Motivate your employees by providing them with their own personal protective overall – with their name on it.
- Present yourself as a service company equipped with high-quality PPE. This gives your client a sense of security and stimulates trust.

Your logo could be here!



The branding service is available for orders of 10 or more protective overalls. Simply get in touch with us.



DEHNcare WJP (Water Jet Protection) is the first protective overall against high-pressure water jets tested and certified according to GSIFA- P15 principles for testing and certifying personal protective equipment (PPE) and to the new EU regulation 2016/425.

Reliable protection in many branches

In industrial plants, for concrete refurbishment, in commercial construction ...

This overall, made of a newly developed material mix, offers protection when cleaning with high-pressure water jets in a wide variety of applications, e.g.:

- Cleaning industrial plants
- Cleaning public spaces
- Stripping metal surfaces, e.g. bridges or monuments
- Cleaning machines and vehicles, e.g. in the commercial construction sector, agriculture, and the transport industry
- Concrete cleaning and refurbishment

Prevention of cuts and lacerations - one worry less!



Safety bonus

The protective overall has been tested at up to 1,000 bars and is resistant to high pressure. Increased protection against abrasions and cuts, in the particularly endangered areas, on the arms, legs and knees.



A true lightweight

The overall only weighs 2.3 kg and is therefore especially light. You have freedom of movement and mobility whatever the job.



Untroubled work

The 2-layer composite material is watertight and cut-resistant yet still breathable. For a high degree of comfort.



Soon ready for use again

The overall can be washed at 60 degrees or dry cleaned. Conserve environmental resources: The overall is reusable, so you need fewer disposable ones.

DEHNcare WJP Protective Overall "Advanced"



"Advanced" protective overall for working with high-pressure water jets.

- High-pressure resistant up to 1000 bar (tested with flat-jet nozzle based on test principle GS-IFA-P15)
- Completely waterproof - including the seams
- Breathable, thus comfortable to wear
- Great freedom of movement due to especially light material
- Environmentally friendly - washable up to 60°
- Certified according to PPE regulation (EU) 2016/425

Protective Overall Against High-Pressure Water Jets

Protective overall against high-pressure water jets, complete with arm and leg protectors.



General technical data:	
High-pressure resistant	≤ 1000 bar
Material	multilayer laminate
Type	breathable and waterproof
Standards / test principles	EN 343, EN 13034 (type 6), GS-IFA-P15 (as basis)
Test parameters according to GS-IFA-P15 flat jet nozzle type B	
- Distance (nozzle - surface of test sample)	7.5 cm
- Angle (high-pressure water jet)	15 °
- Speed (feed)	0.5 m/s
- Quantity of water (high-pressure water jet)	22 l/min
- Pressure (high-pressure water jet)	1200 bar*

Type WJP OC ...	S	M
Part No.	786 741	786 742
Size	48 (S)	50 (M)

Type WJP OC ...	L	XL
Part No.	786 743	786 744
Size	52 (L)	54 (XL)

Type WJP OC ...	XXL	3XL
Part No.	786 745	786 746
Size	56 (XXL)	58 (3XL)

Accessories for DEHNcare WJP Protective Overall "Advanced"

Hood

Hood for protective overall against high-pressure water jets.



Type	WJPOH
Part No.	786 770
Fastening	using press studs



Attachable hood.



Replaceable arm and leg protectors.

Accessories for DEHNcare WJP Protective Overall "Advanced"

Overall

Overall without arm and leg protectors.



Type	WJPO S	WJPO M
Part No.	786 751	786 752
Size	48 (S)	50 (M)

Type	WJPO L	WJPO XL
Part No.	786 753	786 754
Size	52 (L)	54 (XL)

Type	WJPO XXL	WJPO 3XL
Part No.	786 755	786 756
Size	56 (XXL)	58 (3XL)

*) The test for protection against penetration of high-pressure water jets is performed with a safety factor of 1.2.

***) Only in conjunction with arm and leg protectors of corresponding size.

Arm protectors

- Increased protection against cuts and puncture wounds
- Reflectors for better visibility
- Silver popper - to start with buttoning



Type	WJPO AP S	WJPO AP M
Part No.	786 761	786 762
Size	48 (S)	50 (M)

Type	WJPO AP L	WJPO AP XL
Part No.	786 763	786 764
Size	52 (L)	54 (XL)

Type	WJPO AP XXL	WJPO AP 3XL
Part No.	786 765	786 766
Size	56 (XXL)	58 (3XL)

Leg protectors

- Increased protection against cuts and puncture wounds
- Reflectors for better visibility
- Silver popper - to start with buttoning



Type	WJPO LP S	WJPO LP M
Part No.	786 781	786 782
Size	48 (S)	50 (M)

Type	WJPO LP L	WJPO LP XL
Part No.	786 783	786 784
Size	52 (L)	54 (XL)

Type	WJPO LP XXL	WJPO LP 3XL
Part No.	786 785	786 786
Size	56 (XXL)	58 (3XL)

DEHNcare WJP Protective Gloves



Protective gloves protect when working with high-pressure water jets up to 1000 bar.

- Safe up to 1,000 bar based on the test principle GS-IFA-P15 (flat-jet nozzle)
- Back of glove with textile reinforcement to protect against mechanical risks
- Excellent fit in five sizes
- Environmentally friendly - washable:
- Certified according to PPE regulation (EU) 2016/425

Protective gloves



General technical data:		
High-pressure resistant	≤ 1000 bar	
Material	Multi-layer laminate, Kevlar	
Type	waterproof	
Standards / test principles	EN 420, EN 388, EN 13034 (type 6), GS-IFA-P15 (as basis)	
Test parameters according to GS-IFA-P15		flat jet nozzle type B
- Distance (nozzle - surface of test sample)	7.5 cm	
- Angle (high-pressure water jet)	15 °	
- Speed (feed)	0.5 m/s	
- Quantity of water (high-pressure water jet)	22 l/min	
- Pressure (high-pressure water jet)	1200 bar*	
Type WJP HP ...	9	10
Part No.	786 717	786 718
Size	9 (L)	10 (XL)
Type WJP HP ...	11	12
Part No.	786 719	786 720
Size	11 (XXL)	12 (3XL)
Type WJP HP ...	13	
Part No.	786 721	
Size	13 (4XL)	

*) The test against high pressure water jet penetration is performed with a safety factor of 1,2.

DEHNcare WJP Protective Socks



The feet are the part of the body most frequently injured.

- Optimal toe, instep and shin protection up to 1,000 bar
NOTE: Protection is only provided when combined with S5 rubber safety boots!
- Tested based on the test principle GS-IFA-P 15 (flat-jet nozzle)
- Excellent fit in four sizes
- Environmentally friendly - washable up to 30°
- Certified according to PPE regulation (EU) 2016/425

Protective socks



General technical data:		
High-pressure resistant	≤ 1000 bar**	
Material	Polyamid / Polyester	
Type	Worn with S5 rubber safety boots	
Standards / test principles	EN ISO 13688, GS-IFA-P15 (as basis)	
Test parameters according to GS-IFA-P15		flat jet nozzle type B
- Distance (nozzle - surface of test sample)	7.5 cm	
- Angle (high-pressure water jet)	15 °	
- Speed (feed)	0.5 m/s	
- Quantity of water (high-pressure water jet)	22 l/min	
- Pressure (high-pressure water jet)	1200 bar*	
Type WJP FP ...	39 40	41 42
Part No.	786 722	786 723
Size	39-40 (M)	41-42 (L)
Type WJP FP ...	43 44	45 46
Part No.	786 724	786 725
Size	43-44 (XL)	45-46 (XXL)

*) The test for protection against penetration of high-pressure water jets is performed with a safety factor of 1.2.

***) Protection is only provided when combined with S5 rubber safety boots!

DEHNcare WJP Protective Overall "Basic"



Modern protective clothing for working with high pressure water jets up to 750 bar.

- Safe up to 750 bar based on the test principle GS-IFA-P 15 (flat-jet nozzle)
- A true lightweight at only 1.6 kg (size M)
- Waterproof and breathable
- Environmentally friendly - washable up to 60°
- Certified according to PPE regulation (EU) 2016/425

Protective overall against high-pressure water jets



General technical data:		
High-pressure resistant	≤ 750 bar	
Material	multilayer laminate	
Type	breathable and waterproof	
Standards / test principles	EN 343, EN 13034 (type 6), GS-IFA-P15 (as basis)	
Test parameters according to GS-IFA-P15	flat jet nozzle type B	
- Distance (nozzle - surface of test sample)	7.5 cm	
- Angle (high-pressure water jet)	15 °	
- Speed (feed)	0.5 m/s	
- Quantity of water (high-pressure water jet)	22 l/min	
- Pressure (high-pressure water jet)	900 bar*	
Type WJP O B ...	S	M
Part No.	786 711 <small>NEW</small>	786 712
Size	48 (S)	50 (M)
Type WJP O B ...	L	XL
Part No.	786 713	786 714
Size	52 (L)	54 (XL)
Type WJP O B ...	XXL	3XL
Part No.	786 715	786 716
Size	56 (XXL)	58 (3XL)

* The test against high-pressure water jet penetration is performed with a safety factor of 1.2.

DEHNcare WJP Head Protection Set



Protected from all sides when working with high-pressure water jets, also against flying particles.

- All-round protection for the head, face and ears
- Components certified according to PPE regulation (EU) 2016/425

Head protection set



Type	WJP HFP SET
Part No.	786 726
Head circumference helmet	52-61 cm
Material of helmet	HDPE plastic
Thickness of face shield	approx. 2 mm
Material of face shield	polycarbonate
SNR value ear muffs	27 dB

Find the right size to get the perfect fit with your DEHNcare personal protective equipment.

Protective clothing - How to take your measurements (cm):

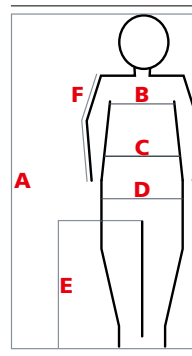

- A Body size:** without shoes, from the top of your head to the soles of your feet
- B Chest measurement:** measure under your arms round the widest part of your chest
- C Waistband:** measure around your waist with the tape measure snug but not digging in
- D Hip size:** measure with the tape measure around the widest part of the hips
- E Inside leg length:** measure from the crotch to the hemline
- F Sleeve length:** measure from the top of the shoulder over the elbow to the wrist bone

DEHNcare ArcFit Indoor / Outdoor

Standard men's sizes (cm)

Ordering size	42	44	46	48	50	52	54	56	58	60	62	64	66	68
	2XS	2XS/XS	XS	S	M	M/L	L	XL	XL/2XL	2XL	3XL	3XL/4XL	4XL	4XL/5XL
Body size	159-171	162-174	165-177	168-180	171-183	174-186	176-188	178-190	180-192	182-194	184-196	186-198	188-200	190-202
Chest measurement	81-87	85-91	89-95	93-99	97-103	101-107	105-111	109-115	113-119	117-123	121-127	125-131	129-135	133-139
Waistband	69-77	73-81	77-85	81-89	85-93	89-97	93-101	99-107	105-113	111-119	117-127	122-132	127-137	132-142
Hip size	91	95	99	103	107	111	115	119	123	127	131	135	139	143
Inside leg length	77.5/78.5	78.5/79.5	79.5/80.5	80.5/81.5	81.5/82.5	82.5/83.5	83.5/84.5	84.5/85.5	85/86	85.5/86.5	86/87	86.5/87.5	87/88	87.5/88.5
Sleeve length	63/63.5	64/64.5	65/65.5	66/66.5	67/67.5	68/68.5	69/69.5	70/70.5	70.5/71	71/71.5	71.5/72	72/72.5	72.5/73	73/73.5

Men's short sizes (cm)

Ordering size	22	23	24	25	26	27	28	29	30
	2XS/XS-K	XS-K	S-K	M-K	M/L-K	L-K	XL-K	XL/2XL-K	2XL-K
Body size	157-166	160-169	163-172	166-175	169-178	171-180	173-182	175-184	177-186
Chest measurement	85-91	89-95	93-99	97-103	101-107	105-111	109-115	113-119	117-123
Waistband	75-83	79-87	83-91	87-95	92-100	97-105	102-110	107-115	113-121
Hip size	95	99	103	107	111	115	119	123	127
Inside leg length	74.5/75.5	75.5/76.5	76.5/77.5	77.5/78.5	78.5/79.5	79.5/80.5	80.5/81.5	81/82	81.5/82.5
Sleeve length	61/61.5	62/62.5	63/63.5	64/64.5	65/65.5	66/66.5	67/67.5	67.5/68	68/68.5

Men's long sizes (cm)

Ordering size	90	94	98	102	106	110	114	118
	XS-L	S-L	M-L	M/L-L	L-L	XL-L	XL/2XL-L	2XL-L
Body size	173-182	176-185	179-188	182-191	184-193	186-195	188-197	190-199
Chest measurement	89-95	93-99	97-103	101-107	105-111	109-115	113-119	117-123
Waistband	75-83	79-87	83-91	87-95	91-99	97-105	103-111	109-117
Hip size	99	103	107	111	115	119	123	127
Inside leg length	83.5/84.5	84.5/85.5	85.5/86.5	86.5/87.5	87.5/88.5	88.5/89.5	89/90	89.5/90.5
Sleeve length	68/68.5	69/69.5	70/70.5	71/71.5	72/72.5	73/73.5	73.5/74	74/74.5

Standard ladies' sizes (cm)

Ordering size	34	36	38	40	42	44	46	48	50	52	54	56
	XS	S	M	M/L	L	XL	XL/2XL	2XL	2XL/3XL	3XL	3XL/4XL	4XL
Body size	163-175	163-175	163-175	163-175	163-175	163-175	163-175	163-175	163-175	163-175	163-175	163-175
Chest measurement	78-85	82-89	86-93	90-97	94-102	99-108	104-113	111-120	117-126	124-133	131-140	138-147
Waistband	70-78	74-82	78-86	82-90	86-94	90-98	95-103	100-108	105-113	110-118	115-123	120-128
Hip size	94	98	102	106	110	114	118	122	126	130	134	138
Inside leg length	77.5	77.5	77.5	77.5	77.5	77.5	77.5	77.5	77.5	77.5	77.5	77.5
Sleeve length	59	59.5	60	60.5	61	61.5	62	62.5	62.5	62.5	62.5	62.5

DEHNcare ArcFit HLP 63

Standard men's sizes (cm)

Ordering size	48	50/52	52/54	56/58	58/60	62/64	64/66
	S	M	L	XL	2XL	3XL	4XL
Body size	166-178	170-182	174-188	178-190	182-194	184-196	188-200
Chest measurement	92-102	98-108	104-114	110-120	116-126	122-132	128-138
Waistband	80-90	86-96	92-102	98-108	104-114	110-120	116-126
Hip size	107	115	123	131	139	147	155
Inside leg length	79.5	81.5	83.5	85.5	86.5	87.5	88.5
Sleeve length	64	65.5	67	68.5	70	71.5	73

DEHNcare ArcClassic jacket and trousers

DEHNcare ArcClassic coat

Standard men's sizes (cm)

Ordering size	46	48	50	52	54	56	58	48/50	52/54	56/58	60/62	64/66
	XS	S	M	L	XL	2XL	3XL	M	L	XL	2XL	3XL
Body size	165-177	168-180	171-183	174-186	176-188	178-190	180-192	172-180	178-185	182-189	186-191	190-197
Chest measurement	92-95	96-100	101-103	104-107	108-111	112-115	116-119	96-103	104-111	112-119	120-127	128-135
Waistband	79-82	83-86	87-90	91-94	95-98	99-102	103-107	-	-	-	-	-
Hip size	104	108	112	116	120	124	128	-	-	-	-	-
Inside leg length	83.5	84.5	85.5	86	86.5	87	87.5	-	-	-	-	-
Sleeve length	69.6	70.2	70.8	71.4	72	72.6	73.2	71	73	75	77	79

DEHNcare WJP protective overall "Advanced" (cm)

DEHNcare WJP protective overall "Basic" (cm)

Ordering size	48	50	52	54	56	58	48	50	52	54	56	58
	S	M	L	XL	2XL	3XL	S	M	L	XL	2XL	3XL
Body size	166-178	170-182	174-186	178-190	182-194	186-198	166-178	170-182	174-186	178-190	182-194	186-198
Chest measurement	88-96	94-102	100-108	106-114	112-120	118-126	88-96	94-102	100-108	106-114	112-120	118-126
Waistband	80-88	86-94	92-100	98-106	104-112	110-118	80-88	86-94	92-100	98-106	104-112	110-118
Hip size	108	114	120	126	132	138	108	114	120	126	132	138
Inside leg length	80.5	82	83.5	85	86	88	80.5	82	83.5	85	86	88
Sleeve length	61.5	63	64.5	66	67.5	69	61.5	63	64.5	66	67.5	69

Glove - Determine size (cm):

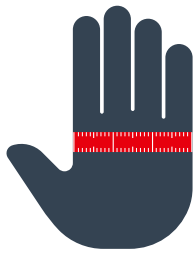

Please use a tape measure to measure the circumference of your hand at the knuckles (without the thumb). Your hand should be open with the fingers together.

DEHNcare APG XT - normal gauntlet (cm)

DEHNcare APG XT - long gauntlet (cm)

Ordering size	7	8	9	10	11	12	13	7	8	9	10	11	12	13
	S	M	L	XL	2XL	3XL	4XL	S	M	L	XL	2XL	3XL	4XL
Total length	330	335	340	350	355	360	365	410	420	430	435	440	445	450
Gauntlet length	140	140	140	140	140	140	140	230	230	230	230	230	230	230
Hand circumference	205	220	240	250	265	270	280	205	220	240	250	265	270	280

DEHNcare APG - normal gauntlet (cm)

DEHNcare APG - long gauntlet (cm)

Ordering size	8	9	10	11	12	8	9	10	11	12
	M	L	XL	2XL	3XL	M	L	XL	2XL	3XL
Total length	310	315	325	330	335	440	450	455	460	465
Gauntlet length	115	115	115	115	115	250	250	250	250	250
Hand circumference	220	240	250	265	270	220	240	250	265	270

DEHNcare WJP protective gloves (cm)

Ordering size	9	10	11	12	13
	L	XL	2XL	3XL	4XL
Total length	372.5	375	377.5	380	382.5
Gauntlet length	165	165	165	165	165
Hand circumference	295	300	305	310	315

DEHNshort - Arc fault protection system

Further information on arc fault
protection:



DEHNshort active arc fault protection system	Page 146
Introduction	Page 147
System description	Page 147
Components	Page 148
Light sensors and accessories	Page 148
Detection devices	Page 148
Quenching devices	Page 149
References	Page 150



DEHNshort -
Arc fault protection system

Safe when it matters most

The importance of arc fault protection is highly relevant for switchgear manufacturers and operators because arc faults in low-voltage switchgear assemblies pose an existential threat to people and equipment. As the operator of electrical installations, you are obliged to take suitable

technical protection measures to protect employees in accordance with occupational health and safety legislation.

In addition to occupational safety, availability requirements, and thus system protection, must be evaluated when planning an electrical power distribution system.

Active arc fault protection systems in low-voltage switchgear assemblies are increasingly becoming established in all relevant regulations and have long since been regarded as state of the art. Your will receive comprehensive support during the planning process. Feel free to contact us.

DEHNshort - Active Arc Fault Protection System



Active arc fault protection system DEHNshort in a switchgear cabinet.

- Protection of persons and installations and system functions in accordance with EN 61439-2, Suppl. 1 (IEC/TR 61641 ed. 3, 2014)
- Use in low-voltage switchgear and controlgear assemblies according to EN 61439-2 after integration tests according to IEC TS 63107: 2020
- Maximum system availability
- Modular system structure
- System status is indicated at the front of the installation

General technical data:	
Rated operating voltage (U_n)	400 - 690 V AC / 50 Hz
Rated short-time withstand current of the quenching devices (I_{cw})	110 kA, 300 ms
Lower response threshold (I_{parc})	5 kA
Max. admissible ambient temperature of the point sensors (during operation)	-20 °C ... +85 °C
Max. admissible ambient temperature of the fibre-optic sensors (during operation)	-5 °C ... +85 °C
Max. admissible ambient temperature of the quenching devices (during operation)	-5 °C ... +70 °C
Typical arc fault extinction times (t_{mtA})	< 3-4 ms at 100 kA
Typical arc fault energies (E_{arc})	40-60 kW



Built-in protective current transformers



Built-in light sensors



Detection devices integrated in the door



Built-in quenching devices

DEHNshort offers optimum protection for persons and switchgear assemblies against the effects of an arc fault. To ensure this, particularly short response times are required in energy-intensive switchgear assemblies. A few milliseconds decide the extent of the effects of an arc fault. DEHNshort is a system that detects the arc fault immediately after ignition, evaluates the recorded sensor signals and quenches the arc fault by generating a three-phase bolted short-circuit.

Functional principle:

Detect

In all feeders, protective current transformers positioned upstream of the feeding circuit breakers detect the overcurrent associated with the arc fault. As a second detection variable, special light sensors detect the extremely bright light of the arc fault. Depending on system requirements, the light sensors are available as a point sensor or fibre-optic sensor.

Evaluate

Electronic detection devices link the sensor signals and activate the quenching devices of the relevant busbar as well as the shunt releases of all feeder circuit breakers in the event of both detection variables appearing.

Quench

By activating the quenching devices, a bolted short-circuit is created in parallel to the arc fault in a very short time. Due to this low-resistance bypass, the voltage collapses and the arc fault is immediately quenched. The thyristors that short-circuit the three phases of the busbar immediately after activation of the quenching devices should be explicitly mentioned in this context. Subsequently, a contact device driven by a spring takes over the channelling of the short-circuit current until it is disconnected by the feeding circuit breakers.

Disconnect completely

To ensure that the switchgear assembly is not loaded with the short-circuit current for longer than necessary - and to ensure additional safety - all feeder circuit breakers receive a disconnection command via floating contacts on the respective shunt releases. This disconnects the arcing busbar section from the mains.

Restoration of service

After rectifying the original fault, replacing the quenching devices and carrying out an insulation test, the system can be put back into operation within a very short time. The arc fault protection realised in this way is considerably higher than the requirements of test criteria 1-7 from EN 61439-2, Suppl. 1 (IEC TR 61641 ed3 of 2014). DEHNshort is used wherever there is a high demand for the protection of people and availability of the electrical power supply.

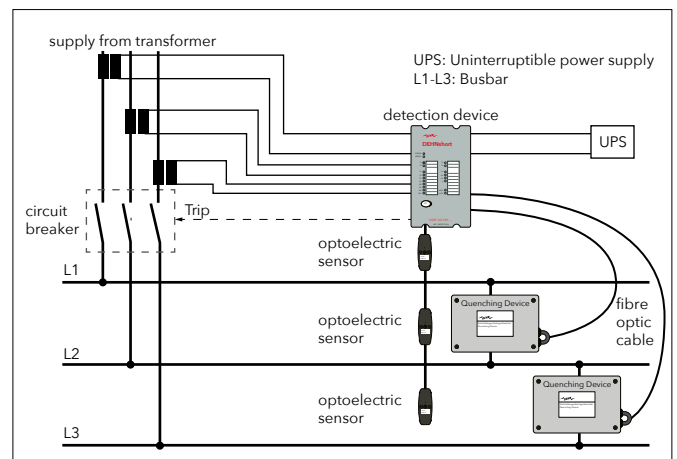

Basic circuit diagram

Detection Device (Current + Light)

Detection unit DSRT DD CPS for current and light detection (DSRT PS point sensors), including output for connecting two DSRT QD II quenching devices.



Type DSRT ...	DD CPS BACA	DD CPS AACA
Part No.	782 030	782 031
Min. / max. voltage (U _N)	18-72 V DC	92-265 V AC / DC
Degree of protection (front side)	IP 50	IP 50
Degree of protection (rear side)	IP 20	IP 20
Dimensions of the front plate (H x W)	177 x 102 mm	177 x 102 mm
Mounting dimensions (H x W x D)	157 x 82 x 164 mm	157 x 82 x 164 mm
Sensor inputs	S1, S2, S3, S4 (3 sensors (DSRT PS) can be connected per channel)	S1, S2, S3, S4 (3 sensors (DSRT PS) can be connected per channel)
Current inputs	1 A / 5 A (IL1, IL2, IL3, Io)	1 A / 5 A (IL1, IL2, IL3, Io)
Binary inputs	24 V DC, 3 mA (BI1, BI2)	24 V DC, 3 mA (BI1, BI2)
Tripping relay	Up to 250 V AC/DC 5 A (T1, T2, T3, T4)	Up to 250 V AC/DC 5 A (T1, T2, T3, T4)
High-speed outputs	Up to 250 V AC/DC 2 A (HS01, HS02)	Up to 250 V AC/DC 2 A (HS01, HS02)
Quenching device outputs	Optical fibre cable (at least 43 mA) (2x TX)	Optical fibre cable (at least 43 mA) (2x TX)
Binary output	24 V d.c 20 mA (B01)	24 V DC 20 mA (B01)
Operating temperature (T _U)	-35 °C ... +70 °C	-35 °C ... +70 °C
Tripping time of the relay	7 ms	7 ms
Tripping time HSO	< 2 ms	< 2 ms
Tripping time TX	< 2 ms	< 2 ms
Arc fault quenching time (t _{mtA})	< 3-4 ms with DSRT QD II	< 3-4 ms with DSRT QD II
Approvals	VdS	VdS

Detection Device (Point Sensor)

DSRT DD PS detection device for light detection (DSRT PS point sensors), including output for connecting two DSRT QD II quenching devices.



Type DSRT ...	DD PS BACA	DD PS AACA
Part No.	782 040	782 041
Min. / max. voltage (U _N)	18-72 V DC	92-265 V AC / DC
Degree of protection (front side)	IP 50	IP 50
Degree of protection (rear side)	IP 20	IP 20
Dimensions of the front plate (H x W)	177 x 52 mm	177 x 52 mm
Mounting dimensions (H x W x D)	157 x 45 x 164 mm	157 x 45 x 164 mm
Sensor inputs	S1, S2, S3, S4 (3 sensors (DSRT PS) can be connected per channel)	S1, S2, S3, S4 (3 sensors (DSRT PS) can be connected per channel)
Binary inputs	24 V DC, 3 mA (BI1, BI2)	24 V DC, 3 mA (BI1, BI2)
Tripping relay	Up to 250 V AC/DC 5 A (T1, T2, T3, T4)	Up to 250 V AC/DC 5 A (T1, T2, T3, T4)
Quenching device outputs	Optical fibre cable (at least 43 mA) (2x TX)	Optical fibre cable (at least 43 mA) (2x TX)
Binary output	24 V DC 20 mA (B01)	24 V DC 20 mA (B01)
Operating temperature (T _U)	-35 °C ... +70 °C	-35 °C ... +70 °C
Tripping time of the relay	7 ms	7 ms
Tripping time TX	< 2 ms	< 2 ms
Arc fault quenching time (t _{mtA})	< 3-4 ms with DSRT QD II	< 3-4 ms with DSRT QD II
Approvals	VdS	VdS

Detection Device (Fibre Optic Sensor)

DSRT DD FS detection device for light detection (DSRT FS fibre optic sensor).



Type DSRT ...	DD FS BAAA	DD FS AAAA
Part No.	782 050	782 051
Min. / max. voltage (U _N)	18-72 V DC	92-265 V AC / DC
Degree of protection (front side)	IP 50	IP 50
Degree of protection (rear side)	IP 20	IP 20
Dimensions of the front plate (H x W)	177 x 52 mm	177 x 52 mm
Mounting dimensions (H x W x D)	157 x 45 x 164 mm	157 x 45 x 164 mm
Sensor inputs	S1, S2, S3 (one fibre optic sensor (DSRT FS) can be connected per channel)	S1, S2, S3 (fibre optic sensor (DSRT FS) can be connected per channel)
Binary inputs	24 V DC, 3 mA (BI1, BI2)	24 V DC, 3 mA (BI1, BI2)
Tripping relay	Up to 250 V AC/DC 5 A (T1, T2, T3, T4)	Up to 250 V AC/DC 5 A (T1, T2, T3, T4)
Binary output	24 V DC 20 mA (B01)	24 V DC 20 mA (B01)
Operating temperature (T _U)	-35 °C ... +70 °C	-35 °C ... +70 °C
Tripping time of the relay	7 ms	7 ms
Arc fault quenching time (t _{mtA})	< 3-4 ms with DSRT QD II	< 3-4 ms with DSRT QD II
Approvals	VdS	VdS

Point Sensor

DSRT PS point sensor for arc detection. Serial connection of max. 3 sensors at each sensor input of DSRT DD CPS and DSRT DD PS devices.



Type DSRT ...	PS
Part No.	782 060
Dimensions (L x W x H)	90 x 32.8 x 19.5 mm
Fixing holes	2x 3.2 mm
Lower response threshold (I _{parc})	5 kA
Detection radius	90° (180°)
Max. distance to the arc fault	2 m (0.5 m)
Sensor wiring	Two cores and shielding
Sensor cable specification	Twisted pair max. 0,5 mm ² , shielded
Max. sensor cable length per sensor channel	100 m
Degree of protection	IP 60
Operating temperature (T _U)	-20 °C ... +85 °C
Approvals	VdS

Accessories for Point Sensor

Fixing clip for point sensors

Fixing clip for securing the DSRT PS point sensor in the switchgear cabinet.



Type	SPBCLPS
Part No.	782 097
Hole pitch	25 mm
Hole Ø	5 mm
PU	5 pc(s)

Fibre Optic Sensor

DSRT FS fibre optic sensor for arc detection. Connection of one sensor at each sensor input of DSRT DD FS devices.



General technical data:	
Diameter	1.2 mm
Bending radius	50 mm
Lower response threshold (I_{parc})	5 kA
Detection radius	360°
Operating temperature (T_U)	-5 °C ... +85 °C

Type DSRT ...	FS 8 1.5	FS 10 1.5
Part No.	782 077	782 081
Sensor length	8 m	10 m
Active sensor length	5 m	7 m
Max. distance to the arc fault	max. 10 cm	max. 10 cm

Type DSRT ...	FS 12 1.5	FS 15 1.5
Part No.	782 085	782 091
Sensor length	12 m	15 m
Active sensor length	9 m	12 m
Max. distance to the arc fault	max. 10 cm	max. 10 cm

Type DSRT ...	FS 17 1.5
Part No.	782 092
Sensor length	17 m
Active sensor length	14 m
Max. distance to the arc fault	max. 10 cm

Accessories for Fibre Optic Sensor

Foam rubber

For fibre optic sensors DSRT FS.



Type	DSRT SR D8 L20
Part No.	782 098
Length	20 mm
Diameter	8 mm
PU	50 pc(s)

Fixing clip

For fibre optic sensors DSRT FS.



Type	DSRT FC D8
Part No.	782 099
Diameter	8 mm
Mounting bore	Ø6.5 mm
PU	50 pc(s)

Quenching Device QD II

Quenching device for connection to DSRT DD CPS and DSRT DD PS detection devices.



Type DSRT ...	QD II
Part No.	782 002
Rated operating voltage (U_e)	400 - 690 V AC, 50 Hz
Rated short-time withstand current (I_{cw})	110 kA, 300 ms
Rated peak withstand current (I_{pk})	242 kA
Standard	IEC 60947-9-1:2019
Dimensions (H x W x D)	177 x 120 x 180 mm
System configurations	TN, TT, IT
Degree of protection	IP 00
Approvals	VdS

Fibre Optic Cable

Prewired fibre optic cables for connecting DSRT DD CPS, DSRT DD PS detection devices and DSRT QD II quenching device units.
1 set = 2 pieces



General technical data:	
Diameter	2.2 mm
Approvals	VdS

Type DSRT ...	LWL 0.75	LWL 2.00
Part No.	782 020	782 022
Length	0.75 m	2 m

Type DSRT ...	LWL 4.00	LWL 8.00
Part No.	782 024	782 028
Length	4 m	8 m

These manufacturers of low-voltage switchgear assemblies have integrated the DEHNshort active arc fault protection system into their switchgear systems in accordance with IEC TS 63107:



TECHNIK FÜR DIE ZUKUNFT



INDUSTRIAL SOLUTION SYSTEMS



Schaltanlagen für Energietechnik GmbH



Further information can be found here:



Safe working on electric railways

You can find more information on our protection solutions for the railway environment at: <https://www.dehn-international.com/en/safely-working-on-electrified-tracks>



Safety equipment for railway workers, technical emergency services and emergency management

Ice removal rod	Page 154
Wireless inspection camera	Page 154
Insulating stick kit for cleaning windscreens	Page 155
Voltage detectors	Page 156
Earthing and short-circuiting devices	Page 164
Voltage-limiting device SDS	Page 171













Safe working on electric railways

In modern rail technology, safety is of paramount importance. The DEHN safety equipment portfolio offers you tools and equipment, including protective and auxiliary equipment, for working in accordance with the five safety rules in the areas of electrified track systems and electrical supply

systems. In this chapter you will find our solutions for safe working on overhead contact lines, substations, switchgear installations, for frequencies of 50 or 16.7 Hz or for DC systems.

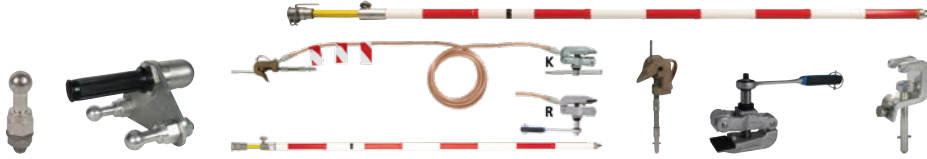
Be it a wireless inspection camera or voltage detector, or telescopic earthing sticks and earthing and short-circuiting devices for railway earthing. All DEHN products have been tried and tested over many years and are as a rule approved by Deutsche Bahn with material and drawing numbers.

Application	Nominal voltage U_N / Frequency f_N	Product	Page
Ice removal rod <ul style="list-style-type: none"> For removing icicles in the vicinity of live parts Solid ice removal hammer Telescopic handle 	up to 15 kV / 16.5 Hz and 25 kV / 50 Hz		154
Wireless inspection camera <ul style="list-style-type: none"> Periodic visual inspection and documentation of the state of electrical installations and equipment (also without special training) Wireless Wi-Fi operation of the camera via smartphone / tablet No downtimes due to disconnection of the installations 	up to 150 kV / 15 ... 60 Hz		154
Insulating stick kit for cleaning windscreens <ul style="list-style-type: none"> Insulating stick kit for cleaning the windscreens of electric locomotives 	up to 7.5 kV / DC and 25 kV / AC		155
Voltage detector for overhead contact line systems <ul style="list-style-type: none"> Suitable for use in wet weather conditions Cost-effective / space-saving transport 	up to 15 kV / 16.7 Hz up to 25 kV / 50 Hz		156
Voltage detectors for switchgear installations <ul style="list-style-type: none"> Suitable for use in wet weather conditions Easy handling 	20 kV / 50 Hz or 16.7 Hz switchable		157
Voltage detectors for traction power lines <ul style="list-style-type: none"> Suitable for use in wet weather conditions Easy handling 	up to 15 kV / 16.7 Hz		158
Voltage detectors for outdoor switching stations <ul style="list-style-type: none"> Suitable for use in wet weather conditions Kit for universal use Cost-effective / space-saving transport 	110 ... 132 kV / 50 and 16.7 Hz 66 kV / 16.7 Hz 110...420kV/16.7Hz		159
Voltage detector for direct current systems <ul style="list-style-type: none"> Suitable for use in wet weather conditions, for indoor and outdoor installations Two-pole (one-/two-stick) 	up to 24 kV / DC voltage		162
Earthing and short-circuiting			164
Voltage-limiting devices SDS			171

German Social Accident Insurance (DGUV) Regulation 3 (formerly accident prevention regulations (BGV A3))

Operating sticks, voltage detectors and EaS devices must be checked according to the DGUV regulation 3 (previously BGV A3) to ensure that they are in good condition and comply with the limit values as specified in the electrotechnical rules. This test is carried out in the high-voltage test laboratory at DEHN and includes, among other things:

- Testing the discharge current
- Testing the protection against bridging
- Testing by visual inspection, manual test and measuring
- Measurement of the total resistance on EaS devices
- Measurement of the relative change in resistance on EaS devices

The maintenance test is documented in a test report and on the device itself.

The intervals for maintenance tests of depend on the conditions of use, e.g. frequency of use, stress due to environmental conditions and transport, etc, however, according to DGUV regulation 3, **at least every 6 years**.



Ice Removal Rod



Removing icicles on a tunnel entrance.

Nominal voltages up to 25 kV

- For removing ice in the vicinity of live parts e.g. outdoor overhead contact lines or tunnel systems
- Solid ice removal hammer made of insulating material
- Insulating stick for 15 kV / 16.7 Hz and 25 kV / 50 Hz systems
- With telescopic handle up to a total length of 3420 mm to 5270 mm

General technical data:

Standard (operating head)	Based on DIN VDE 0682-411 and DIN VDE V 0681-1
Standard (insulating stick)	Based on DIN VDE 0682-411 and DIN VDE V 0681-1
For use in wet weather conditions	
Material (insulating stick)	Glass-fibre reinforced polyester tube
Material (handle)	Glass-fibre reinforced polyester tube

Operating Head (Hammer)

With plug-in coupling.



Type	AK 25 ESH STK SN7361
Part No.	766 372
Nominal voltage (U _N)	1 ... 25 kV
Total length (l _G)	400 mm
Dimensions (operating head)	300 x 56 mm
For use at	

Insulating Stick

With plug-in coupling for operating head (hammer).



Type	ISN 25 STK 900SN7360
Part No.	766 371
Nominal voltage (U _N)	1 ... 25 kV
Total length (l _G)	920 mm
For use at	

Telescopic Extension Handle

With plug-in coupling for the insulating stick and end fitting with eye.



Type	HVTC STK 4100 SN7359
Part No.	766 469
Total length (l _{G max} / l _{G min})	4120 / 2290 mm
For use at	

Wireless Inspection Camera



System monitoring with wireless inspection camera and live display on a smartphone.

Nominal voltages up to 150 kV / 15 to 60 Hz

- Wireless inspection camera for periodic visual inspection and for documenting the state of electrical installations and equipment (also without special training)
- Brings the invisible to light
- Facilitates work, increases safety, saves time



General technical data:

Standard	Based on EN 50508 (DIN VDE 0682-213)
Temperature range (T _U)	0 °C ... +40 °C
Not for use in wet weather conditions	
Material (enclosure)	PUR
Material (camera)	Aluminium

AC2 digital camera set



Kit includes:

No.	Description	Type
1	Plastic case	KKL DIGIK AC2
2	Digital camera enclosure	G DIGIK AC2
3	Camera and battery module incl. magn. protective cover	DIGIK AC2
4	Magnetic adapter holder with 1/4" thread	MAH DIGIK AC2
5	Rigid adapter gear coupling	ADS ZK 185

Type	SET DIGIK AC2
Part No.	766 480 <small>NEW</small>
Nominal voltage (U _N)	up to 150 kV
Frequency	15-60 Hz
Resolution	12 megapixels
Objective	Ultra-wide angle (155° field of view)
Digital zoom	4x
sensor	1/1.7" 4K CMOS sensor
Image stabiliser	Electronic
Formats	JPEG/RAW and MP4
Internal memory	22 GB
Ext. SD card	microSD (max. 256 GB) *)
Equipment	Remote control via app
Voice command	Yes
Interfaces	USB type-C
Dimensions (case)	395 x 290 x 105 mm

*) Handle, insulating sticks and micro SD card are not included.

Macro lens

For close-ups



Type	MO DIGIK AC2
Part No.	766 483 <small>NEW</small>
Dimensions	40 x 40 x 10 mm

Accessories for wireless Inspection Camera

Operating stick set

Set for animal guard adapter and wireless inspection camera.



Type	ASSN 36 STK ZK
Part No.	766 380
Nominal voltage (U _N)	1 ... 36 kV
Max. total length (l _{G,max})	6780 mm
DB drawing No.	3 Egbw 04.61

Accessories for Operating sticks



Installation of the "animal guard" with the help of an adapter to protect birds and small animals.

Adapter for animal guard

Adapter with gear coupling for mounting the 3M Animal Guard.



Type	AD ZK 3M 170
Part No.	766 059
Total length (l _G)	170 mm
DB drawing No.	Egbw 04.71

Insulating Stick Kit for Cleaning the Windscreens of Electric Locomotives



Insulating stick kit used for cleaning the windscreen of an electric locomotive.

Nominal voltages up to 7.5 kV / DC and 25 kV / AC

- For cleaning the windscreens of electric locomotives
- Protection against accidental contact with live parts (e.g. overhead contact lines)
- Adjustable inclination angle of the operating head



General technical data:

Standard	Wet test in accordance with EN/IEC 61243-1 (DIN VDE 0682-411)
For use in wet weather conditions	
Material (insulating tube)	Glass-fibre reinforced polyester tube
End fitting	Non-slip plastic cap



Insulating Stick Kit for Cleaning Windscreens



Parts list:			
No.	Part No.	No.	Part No.
1	766 048	3	766 056
2	766 055	4	766 057

For more detailed information on these products, see * www.dehn-international.com.

Type	IS 25 ZK RK 3160
Part No.	766 340
Nominal voltage U _N AC	Up to 25 kV
Nominal voltage U _N DC	Up to 7.5 kV
Total length (l _G)	3160 mm
Insertion depth (l ₀)	1630 mm



Adapter with gear coupling for attaching the cleaning head.



The hook-and-loop fastener allows fast replacement of the cleaning pad.



The universal gear coupling can be adjusted from 0° to 90° in 30° increments.

Note:

In accordance with EN/IEC 61243-1 (DIN VDE 0682-411), IS 25 ZK 2885 insulating sticks and AD ZK 25 200 adapters can also be used in wet weather conditions for nominal voltages up to 7.5 kV DC and 25 kV AC. The cleaning agent must not exceed the maximum conductivity of 1000 µS / cm. Due to the risk of bridging, water and cleaning agents must not be used to clean live parts of installations.

Spare Parts for Insulating Stick Kit

Cleaning head

Flexibly adjustable, for attaching cleaning pads.



Type	RK 230 100 AS25
Part No.	766 056
Dimensions	230 x 100 mm
Diameter	25 mm

Rectangular cleaning pad



Type	RP 250 115 20
Part No.	766 057
Dimensions	250 x 115 x 20 mm
PU	10 pc(s)

Voltage detectors for overhead contact line systems

PHE Voltage Detector Kit



PHE voltage detector with visual indicator used on an overhead contact line of German Railways (DB).

General Information:	
Standard	DIN VDE 0681-6
For use in wet weather conditions	
Indication	Visual
Self-testing element	Yes
Material (test electrode)	St/gal Zn
Material (test prod)	Glass-fibre reinforced polyester tube
Material (indicator)	Plastic, fully insulated
Material (insulating stick)	Glass-fibre reinforced polyester tube

Parts list:			
No.	Part No.	No.	Part No.
1	766 619	7	766 076
2	766 678*	8	766 077
3	766 677*	9	766 889
4	766 072	10	766 602
5	766 075	11	766 704
6	766 073		

For more detailed information on these products, see * www.dehn-international.com.

Nominal voltage 15 kV / 16.7 Hz

Easy and safe testing

- For overhead contact lines of electric railways
- Cost-effective / space-saving transport
- Easy to use due to simple plug-in system



Nominal Voltage 15 kV / 16.7 Hz

Detachable (four elements).



Type PHE 15 16.7 ...	4T TA
Part No.	766 616
Nominal voltage (U _N)	15 kV
Frequency	16.7 Hz
Total length (l _G)	4890 mm
Insertion depth (l _O)	1675 mm
DB drawing No.	3 Ebgw 02.51
DB material No.	237 129

Nominal Voltage 15 kV / 16.7 Hz
(for Transport in Motor Vehicles)

Detachable (six elements).

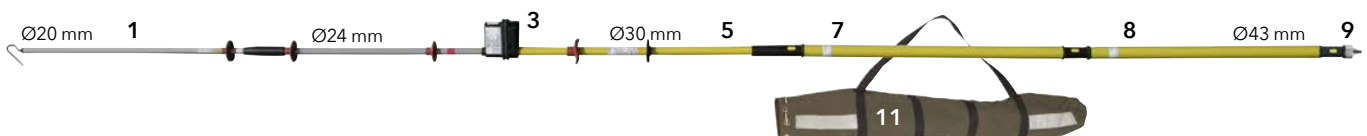

Type PHE 15 16.7 ...	6T TA
Part No.	766 617
Nominal voltage (U _N)	15 kV
Frequency	16.7 Hz
Total length (l _G)	4900 mm
Insertion depth (l _O)	1675 mm
DB drawing No.	3 Ebgw 02.53
DB material No.	652 975



Two-part test prod with robust threaded coupling (six-part kit for transport in motor vehicles).

Volt. detec. f. overhead contact line systems

PHE III Voltage Detector

Nominal voltages up to 25 kV / 50 Hz
Safe verification of isolation from supply voltage

- Reliable indication
- Easy to use
- Cost-effective / space-saving transport

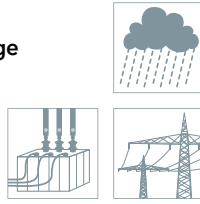

General technical data:	
Standard	EN/IEC 61243-1 (DIN VDE 0682-411)
Temperature range	-25 °C ... +55 °C, climatic category N
Design	Complete
For use in wet weather conditions	
For	Indoor and outdoor installations
Indication	Acoustic and visual
Self-testing element	Yes
Material (test electrode)	Copper alloy/gal Sn
Material (test prod)	Glass-fibre reinforced epoxy resin tube
Material (indicator)	Plastic, fully insulated
Material (insulating stick)	Glass-fibre reinforced polyester tube

Nominal Voltages up to 25 kV / 50 Hz

For the overhead contact lines of electric railways.
Category "S" for single-ended monophas systems.



Type	PHE3 25 S 50 1P
Part No.	767 125
Nominal voltage (U _N)	25 kV
Total length (l _G)	1680 mm
Insertion depth (l _O)	880 mm

Voltage detectors for switching stations

PHE4 Voltage Detector Medium Voltage

- Self-test of all live parts including test prod
- Unique plug-in coupling system
- Integrated visual and acoustic indication
- Also for use in wet weather conditions

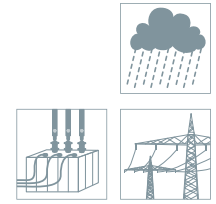

General technical data:	
Standard	EN/IEC 61243-1 (DIN VDE 0682-411)
Temperature range	-25 °C ... +70 °C, climatic category N and W
Design	Complete
For use in wet weather conditions	
For	Indoor and outdoor installations
Indication	Acoustic and visual
Self-testing element	Yes
Material (test electrode)	Cu alloy/gal Sn
Material (test prod)	Glass-fibre reinforced epoxy resin tube
Material (indicator)	Plastic, fully insulated
Material (insulating stick)	Glass-fibre reinforced polyester tube

Nominal Voltage up to 20 kV / 50 Hz or 16.7 Hz, switchable

Category "S" for switchgear installations and overhead lines.



Type PHE4 ...	U 6 20 S 16.7 50
Part No.	783 430
Nominal voltage (U _N)	6 ... 20 kV
Frequency	50 / 16.7 Hz
Total length (l _G)	1600 mm
Insertion depth (l _O)	800 mm

^{*)} all circuits including test prod

Nominal Voltage up to 20 kV / 16.7 Hz, M12 Thread

Category "S" for switchgear installations and overhead lines.



Type PHE4 ...	6 20 S 16.7
Part No.	783 420
Nominal voltage (U _N)	6 ... 20 kV
Frequency	16.7 Hz
Total length (l _G)	1600 mm
Insertion depth (l _O)	800 mm

^{*)} all circuits including test prod

Voltage detectors for switching stations

PHE Voltage Detector



PHE voltage detector with visual indication.

Nominal voltages up to 20 kV / 50 Hz or 16.7 Hz
Easy and safe testing

- Reliable indication
- Easy to use



General Information:

Standard	EN/IEC 61243-1 (DIN VDE 0682-411) and DIN VDE V 0682-421
Temperature range	-25 °C ... +55 °C, climatic category N
Design	Complete
For use in wet weather conditions	
For	Indoor and outdoor installations
Indication	Visual
Self-testing element	Yes
Material (test electrode)	Copper alloy/gal Sn
Material (test prod)	Glass-fibre reinforced epoxy resin tube
Material (indicator)	Plastic, fully insulated
Material (insulating stick)	Glass-fibre reinforced polyester tube

Nominal Voltage Ranges up to 20 kV / 16.7 Hz

For single-ended monophasic switchgear installations and point heating systems.



Type PHE ...	6 20 S 16.7 1P
Part No.	767 415
Nominal voltage (U _N)	6 ... 20 kV
Frequency	16.7 Hz
Total length (l _G)	1560 mm
Insertion depth (l _O)	770 mm
DB drawing No.	3 Ebgw 02.52
DB material No.	738 302

Nominal Voltage Ranges
20 kV / 50 Hz or 16.7 Hz,
switchable



For three-phase systems and single-ended monophasic installations.

Special features of the switchable voltage detector:

The selector switch can be moved into three positions for the relevant voltage and frequency ranges:
3 ... 10 kV / 50 Hz - three-phase systems
6 ... 20 kV / 50 Hz - three-phase systems
6 ... 20 kV / 16.7 Hz - single-ended monophasic systems
For safety reasons, the detector can only be switched on if the selector switch is switched to the most sensitive range of 3 kV to 10 kV / 50 Hz. The switch snaps into the relevant position and provides protection against accidental switching. A magnetically operated, wear-resistant reed switch changes the switching position.



Type PHE ...	3 20 S FU 1P
Part No.	767 416
Nominal voltage (U _N)	3 ... 20 kV
Frequency	16.7 and 50 Hz
Total length (l _G)	1560 mm
Insertion depth (l _O)	770 mm
DB drawing No.	3 Ebgw 02.54
DB material No.	743 361

Voltage detectors for traction power lines

Nominal Voltage 15 kV / 16.7 Hz

For traction power lines. Hook-shaped electrode and end fitting with plug-in coupling and non-slip eye included.



Use for traction power lines

Voltage detectors for traction power lines have a shorter extension than voltage detectors for overhead contact lines. To ensure reliable indication, the PHE 15 16.7 BEL STK voltage detector may only be used for traction power lines and not for other components of overhead contact lines. Moreover, it must not be used from ladder trolleys for overhead contact lines. Traction power lines are supply lines, line feeders, bypass lines, connecting lines, feeder lines, 15 kV cables, cable sealing ends, switch lines and transverse switch lines.



Type PHE ...	15 16.7 BEL STK
Part No.	767 413
Nominal voltage (U _N)	15 kV
Frequency	16.7 Hz
Total length (l _G)	1645 mm
Insertion depth (l _O)	765 mm
DB drawing No.	3 Ebgw 02.55
DB material No.	964 851

Voltage detectors for outdoor switching stations

PHE III Voltage Detector Kit



PHE III voltage detector used on a 110 kV outdoor station.

Nominal voltages up to 110 ... 132 kV / 50 and 16.7 Hz and 66 kV / 16.7 Hz

Safe verification of isolation from supply voltage

- Reliable indication
- Easy to use
- Multi-purpose kit
- Cost-effective / space-saving transport

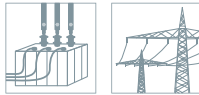

General technical data:	
Standard	EN/IEC 61243-1 (DIN VDE 0682-411)
Temperature range	-25 °C ... +55 °C, climatic category N
Design	Complete
For use in wet weather conditions	
For	Indoor and outdoor installations
Indication	Acoustic and visual
Self-testing element	Yes
Material (test electrode)	Copper alloy/gal Sn
Material (test prod)	Glass-fibre reinforced epoxy resin tube
Material (indicator)	Plastic, fully insulated
Material (insulating stick)	Glass-fibre reinforced polyester tube

Parts list:			
No.	Part No.	No.	Part No.
1	766 924	7	767 128
2	766 923	8	766 115
3	767 771	9	766 120
4	767 129	10	766 889
5	769 715	11	767 996
6	766 352		

For more detailed information on these products, see * www.dehn-international.com.

Nominal Voltage Range 110 ... 132 kV / 50 and 16.7 Hz

For 50 Hz three-phase systems and 16.7 Hz centre-earthed monophas traction power lines. Range does not have to be switched.



Category "S"

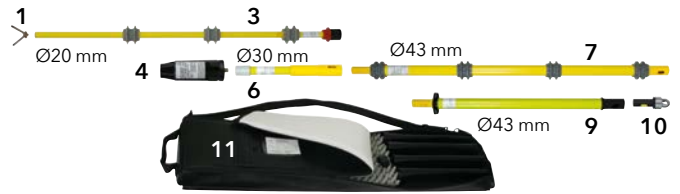

Type	PHE3S 110 132 S
Part No.	767 131
Nominal voltage (U _N)	110 ... 132 kV
Total length (l _G)	3440 mm
Insertion depth (l _O)	880 mm
DB drawing No.	3 Eku 710 001
DB material No.	01 101 358

Nominal Voltage 66 kV / 16.7 Hz

Category "S" for single-ended monophas systems



Type	PHE3 66 16.7S SN7705
Part No.	769 714
Nominal voltage (U _N)	66 kV
Total length (l _G)	2980 mm
Insertion depth (l _O)	880 mm

Voltage detectors for outdoor switching stations

PHE4 Voltage Detector High Voltage



PHE4 voltage detector applied in a 110 kV outdoor switching station.

- High nominal voltage range
- Unique plug-in coupling system
- Integrated visual and acoustic indication
- Also for use in wet weather conditions

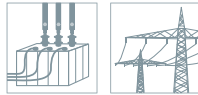

General Information:

Norm	EN/IEC 61243-1 (DIN VDE 0682-411)
Temperature range	-25 °C ... +70 °C, climatic category N and W
Design	Complete
For use in wet weather conditions	
For	Indoor and outdoor installations
Indication	Acoustic and visual
Self-testing element	Yes
Material (test electrode)	Copper alloy/gal Sn
Material (test prod)	PP
Material (indicator)	Plastic, fully insulated
Material (insulating stick)	Glass-fibre reinforced polyester tube

Nominal Voltage Range
110 ... 132 kV / 50 & 16.7 Hz,
M12 Thread



Category "S" for switchgear installations and overhead lines.



Type PHE4 ...	110 132 S 16.7 50
Part No.	783 460
Nominal voltage (U _N)	110 ... 132 kV
Frequency	50 & 16.7 Hz
Total length (l _G)	3420 mm
Insertion depth (l ₀)	910 mm

^{*)} all circuits without test prod

ASP Non-Contact Voltage Detector Kit



Use of an ASP distance voltage detector in an outdoor switching station.

Nominal voltage range 110 ... 132 kV / 16.7 Hz

Easy and safe testing

- Easy to use due to compact design
- Cost-effective / space-saving transport



General Information:

Temperature range	-25 °C ... +55 °C
For use in wet weather conditions	
For	Overhead lines and outdoor switching stations
Indication	Acoustic and visual
Self-testing element	Yes
Design	Single-pole
Material (indicator)	Plastic, fully insulated, black
Material (electric field sensor)	Plastic, black
Material (insulating stick)	Glass-fibre reinforced polyester tube

Parts list:

No.	Part No.	No.	Part No.
1	767 576	3	766 369
2	767 564	4	767 574

For more detailed information on these products, see * www.dehn-international.com.

Category "L", 16.7 Hz

Category "L" for centre-earthed monophas traction power lines.



Type	ASPS 110 132 16.7 L
Part No.	767 565
Nominal voltage (U _N)	110 ... 132 kV
Frequency	16.7 Hz
Total length (l _G)	960 mm
DB drawing no.	3 Eku 710 002

Voltage detectors for outdoor switching stations

HSA 194 High-Voltage Indicator



High-voltage indicator used on a 110 kV overhead line.

Nominal Voltage Range
110 ... 420 kV

With plug-in coupling as end fitting for extending the handle.
Storage bag included in delivery.



Type	HSA194 110 420 16.7
Part No.	767 542
Nominal voltage range (U _N)	110 ... 420 kV
Frequency	16.7 Hz
Total length (l _G)	940 mm
Insulating clearance (l _I)	540 mm
DB drawing No.	3 Ekgw 02.54
Verification while climbing the tower	No

Nominal voltage rang 110 ... 420 kV / 16.7 Hz
Easy and safe testing

- For contactlessly verifying that switchgear and high-voltage overhead lines or centre-earthed monophas traction power lines are dead
- Cost-effective / space-saving transport



General Information:

Temperature range	- 25 °C ... + 55 °C, climatic category N
For use in wet weather conditions	
Indication	Acoustic and visual
Self-testing element	Yes
Material (insulating stick)	Glass-fibre reinforced polyester tube

To verify absence of voltage from the tower cross arm, place the green ring of the high-voltage indicator on the last earthed protective fitting (or earthed insulator cap) of the insulator so that the operating head of the high-voltage indicator (see Fig.) points towards the overhead conductor to be tested, which is attached to the other insulator end (longitudinal axis of the device in parallel to the longitudinal axis of the insulator). If the conductor is energised, there is a visual (red flashing light) and acoustic signal.

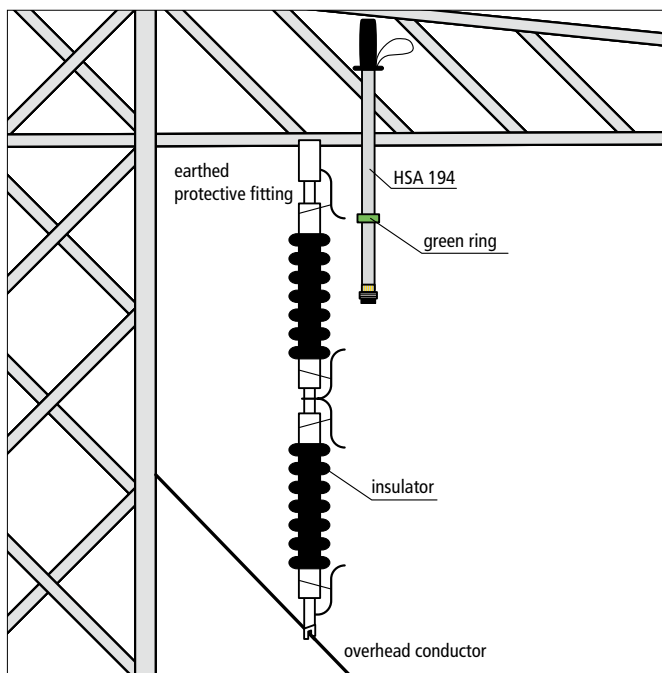

Voltage detectors for DC voltage systems

PHE/G DC Voltage Detector



PHE/G II DC voltage detector for DC links (ICE power car).

Nominal voltages up to bis 24 kV DC

Safe verification of isolation from supply voltage

- For use in direct voltage systems (electrified rail networks, DC links)
- Reliable indication
- Easy to use due to compact design
- User-friendly

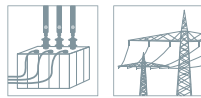

The test prod of DC voltage detectors is colour-coded according to the polarity of the test prod:

- positive pole - red;
- negative pole - blue.

General technical data:

Standard	Based on EN/IEC 61243-1 (DIN VDE 0682-411)
Temperature range	-25 °C ... +55 °C, climatic category N
For use in wet weather conditions	
For	Indoor and outdoor installations
Indication	Visual
Self-testing element	Yes
Material (test prod)	Glass-fibre reinforced polyester tube
Material (indicator)	Plastic, fully insulated
Material (insulating stick)	Glass-fibre reinforced polyester tube
Material (earthing / connecting cable)	Copper cable, highly flexible

PHE/G I for Switchgear Installations, positive pole on indicator with test prod



One stick

- For direct voltage systems with earthed negative pole
- Positive pole: indicator with test prod
- Negative pole: earth clamp with magnet



Type	PHEG1.S P SN7401
Part No.	767 666
Threshold voltage (U _t)	120 V
Nominal voltage (U _N)	1 ... 24 kV
Length (earthing cable)	2000 mm
Total length (l _G)	1260 mm
Insertion depth (l _O)	535 mm

PHE/G I for Switchgear Installations, positive pole on indicator with test prod, angled



One stick

- For direct voltage systems with earthed negative pole
- Positive pole: Indicator with test prod
- Negative pole: Earth clamp



Type	PHEG1.S P SN7240
Part No.	767 636
Threshold voltage (U _t)	60 V
Nominal voltage (U _N)	3.8 kV
Length (earthing cable)	4000 mm
Total length (l _G)	1100 mm

Voltage detectors for DC voltage systems

PHE/G I for Overhead Contact Lines, positive pole on indicator with test prod



One stick (three elements)

- For direct voltage systems with earthed negative pole
- Positive pole: Indicator with test prod
- Negative pole: Earth clamp

PHE/G I for Overhead Contact Lines, negative pole on indicator with test prod



One stick (four elements)

- For DC voltage systems with earthed positive pole
- Negative pole: Indicator with test prod
- Positive pole: Earth clamp



Type	PHEG1 FD P 3
Part No.	767 610
Threshold voltage (U _t)	1.1 kV
Nominal voltage (U _N)	3.0 kV
Length (earthing cable)	6000 mm
Total length (l _G)	4125 mm

Type	PHEG1 FD M SN7223
Part No.	767 614
Threshold voltage (U _t)	0.825 kV
Nominal voltage (U _N)	1.65 kV
Length (earthing cable)	8000 mm
Total length (l _G)	4060 mm

PHE/G II, angled positive pole



Two sticks

- For unearthed direct voltage installations
- For DC links
- Positive pole: Insulating stick
- Negative pole: Test prod

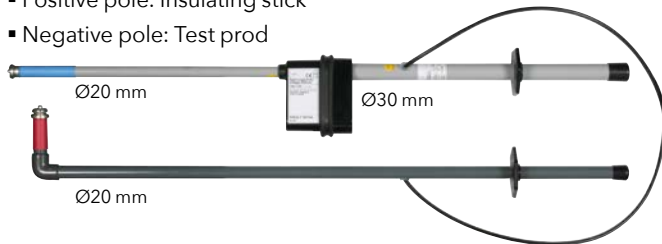

Type	PHEG2 P SN7346
Part No.	767 639
Threshold voltage (U _t)	150 V
Nominal voltage (U _N)	750 V
Length (connecting cable)	1200 mm
Total length (l _G)	1100 mm

PHE/G II for Switchgear Installations and DC Links



Two sticks

- For unearthed direct voltage installations
- For DC links (e.g. electric locomotives; Part No. 767 647)
- Positive pole: Indicator with test prod
- Negative pole: Insulating stick



General technical data:	
Length (connecting cable)	1200 mm

Type	PHEG2 P SN7552	PHEG2 P SN7259
Part No.	767 647	767 645
Threshold voltage (U _t)	90 V	120 V
Nominal voltage (U _N)	1 ... 4.2 kV	1 ... 12 kV
Total length (l _G)	600 mm	1085 mm

PHE/G II for Switchgear Installations



Two sticks

- For unearthed direct voltage installations
- For DC links
- Positive pole: Indicator with test prod
- Negative pole: Insulating stick



Type	PHEG2.P SN7517
Part No.	767 671
Threshold voltage (U _t)	90 V
Nominal voltage (U _N)	1 ... 24 kV
Length (connecting cable)	1200 mm
Total length (l _G)	1260 mm
Insertion depth (l ₀)	545 mm

Accessories

Artificial Leather Bag

Artificial Leather Bag for PHE4 and PHE

With carrier handle



Type KLT ...	247 10 22
Part No.	766 602
Dimensions	2470 x 220 x 100 mm
Colour	Black ●

Artificial Leather Bag for PHE/G

With carrier handle



Type KLT ...	160 17
Part No.	766 614
Dimensions	Ø170 x 1600 mm
Colour	Black ●

Canvas Bag

Canvas Bag for PHE and PHE/G I

With carrier handle.



Type STT ...	120 30 15
Part No.	766 704
Dimensions	1220 x 390 x 150 mm
Colour	Olive ●

Fixed Ball Points



Straight fixed ball point mounted on a busbar.

- Suitable for fixing busbar connections according to DIN 43673-1
- Self-locking nut
- M12 or M16 non-cutting formed female thread
- M12 or M16 threaded pin

General technical data:	
Standard	EN/IEC 61230 (DIN VDE 0683-100) and based on DIN 48088-1
Material (fixed ball point)	E-Cu/gal Sn
Material (threaded pin)	StSt A2-70
Hexagon nut	DIN 985-M12-8 / gal Zn; DIN 985-M16-8 / gal Zn
Tightening torque	M10: 30-40 Nm; M12: 50-65 Nm; M16: 100-110 Nm

Straight with Threaded Pin, Nut and Washer



General technical data:	
Fixed ball point Ø	25 mm
Max. short-circuit current I_k 0.06 s	34.0 kA
DB drawing No.	3 Ebgw 01.63

Type KFP 25 ...	M16 25 SKM	M12 35 SKM
Part No.	755 626	755 627
Dimensions	M16 x 25 mm	M12 x 35 mm
DB material No.	157 541	622 014

Type KFP 25 ...	M16 45 SKM
Part No.	755 646
Dimensions	M16 x 45 mm
DB material No.	157 542

Straight with Threaded Pin



Type KFP 25 ...	M16 25
Part No.	755 636
Fixed ball point Ø	25 mm
Dimensions	M16 x 25 mm
Max. short-circuit current I_k 0.06 s	34.0 kA
DB drawing No.	3 Ebgw 01.63
DB material No.	609 426

Earth Connecting Plates



Earth connecting plate with fixed ball points and ball head cap with plastic handle.

- Connecting plate with high short-circuit current carrying capacity
- Single-pole connection of the phase arms
- For connecting single-pole earthing and short-circuiting devices to transformers of overhead line masts or to fuse holders
- For fixed ball points (Ø20 mm, Ø25 mm)

General technical data:	
Standard	EN/IEC 61230 (DIN VDE 0683-100) and fixed points in accordance with DIN 48088-1
Material (plate)	Aluminium
Material (terminal lug)	4 mm: Cu / gal Sn; 6 mm: HDG steel
Material (fixed point)	E-Cu / brass (CuNi2Si) / gal Sn

With two Fixed Ball Points and Ball Head Cap

With adjustable ball head cap (Ø25 mm) and plastic handle. For connecting two single-pole earthing and short-circuiting devices to one fixed ball point (Ø25 mm).



Type EAP ...	2 25 KKH HG
Part No.	728 501
Fixed point Ø	25 mm
DB drawing No.	3 Ebgw 01.66
DB material No.	157 540

Terminal Lug with one Fixed Ball Point

For connection to a fuse holder.



Type EAP ...	25 SIT US OL
Part No.	728 503
Fixed point Ø	25 mm
DB drawing No.	4 Ebgw 01.60
DB material No.	157 545

Terminal Lug with two Fixed Ball Points

For connection to the mast.



Type EAP ...	2 25 MA US OL
Part No.	728 502
Fixed point Ø	25 mm
DB drawing No.	3 Ebgw 01.61
DB material No.	157 548

Kits for Railway Applications

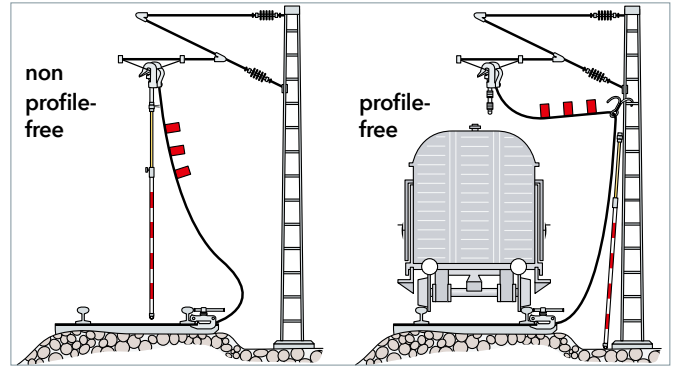

General technical data:	
Standard	EN/IEC 61230 (DIN VDE 0683-100)
Temperature range	-25 °C ... +55 °C

Parts list:			
No.	Part No.	No.	Part No.
1	784 755	10	751 150
2	773 251	11	740 124
3	784 352	12	769 502
4	792 450	13	769 508
5	792 455	14	769 515
6	774 251	15	769 352
7	751 085	16	761 015
8	751 120	17	785 111
9	751 040	18	700 000

Kit for Overhead Contact Lines (non-profile-free)

Telescopic earthing stick with adjusting ring (max. 5 m long)



For more detailed information on these products, see * www.dehn-international.com.

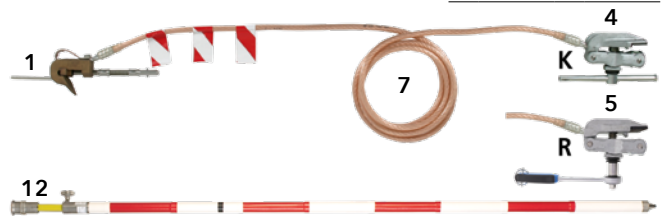

Type BEV ...	OL NPF K	OL NPF R
Part No.	750 210	750 218
Design	Tommy bar	Ratchet
Cable cross-section	50 mm ²	50 mm ²
Cable length	8500 mm	8500 mm
Max. short-circuit current I _k 0.06 s	32.0 kA	32.0 kA
DB drawing No.	3 Ebgw 01.51	3 Ebgw 01.51
DB material No.	237 117	-

Kit for Overhead Contact Lines (profile-free *)

Telescopic earthing stick with adjusting ring (max. 5 m long).

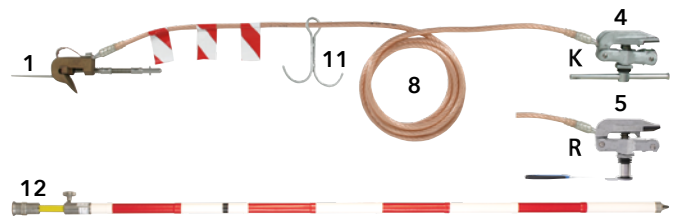

Type BEV ...	OL PF K	OL PF R
Part No.	750 211	750 219
Design	Tommy bar	Ratchet
Cable cross-section	50 mm ²	50 mm ²
Cable length	12000 mm	12000 mm
Max. short-circuit current I _k 0.06 s	32.0 kA	32.0 kA
DB drawing No.	3 Ebgw 01.51	3 Ebgw 01.51
DB material No.	237 118	-

*) Profile-free earthing means that the earthing cable can be suspended on the tower thus allowing for limited diesel locomotive operation.

Kit for Overhead Contact Lines (profile-free *)

Telescopic earthing stick with cable entry and suspension hook (max. 5 m long).

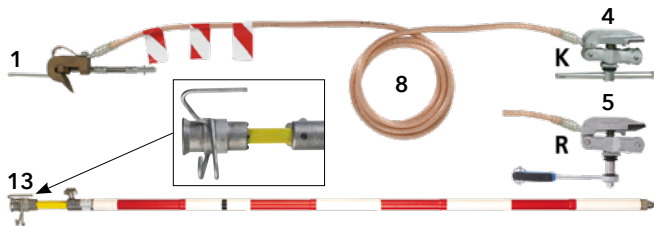

Type BEV ...	OL PF V2 K	OL PF V2 R
Part No.	750 214	750 221
Design	Tommy bar	Ratchet
Cable cross-section	50 mm ²	50 mm ²
Cable length	12000 mm	12000 mm
Max. short-circuit current I _k 0.06 s	32.0 kA	32.0 kA
DB drawing No.	3 Ebgw 01.51	3 Ebgw 01.51
DB material No.	237 115	-

*) Profile-free earthing means that the earthing cable can be suspended on the tower thus allowing for limited diesel locomotive operation.

Kit for Overhead Contact Lines for Transport in Motor Vehicles (non-profile-free)

For technical emergency service and emergency management
Telescopic earthing stick kit consisting of six elements, pluggable (max. 5 m long).



Type BEV ...	OL NPF PKW K	OL NPF PKW R
Part No.	750 196	750 216
Design	Tommy bar	Ratchet
Cable cross-section	50 mm ²	50 mm ²
Cable length	8500 mm	8500 mm
Max. short-circuit current I _k 0.06 s	32.0 kA	32.0 kA
DB drawing No.	3 Ebgw 01.67	3 Ebgw 01.67
DB material No.	237 125	-

Kit for Overhead Contact Lines for Transport in Motor Vehicles (profile-free *)

For technical emergency service and emergency management

Telescopic earthing stick kit consisting of six elements, pluggable (max. 5 m long).



Type BEV ...	OL PF PKW K	OL PF PKW R
Part No.	750 200	750 217
Design	Tommy bar	Ratchet
Cable cross-section	50 mm ²	50 mm ²
Cable length	12000 mm	12000 mm
Max. short-circuit current I _k 0.06 s	32.0 kA	32.0 kA
DB drawing No.	3 Ebgw 01.67	3 Ebgw 01.67

*) Profile-free earthing means that the earthing cable can be suspended at the tower, thus allowing for limited diesel locomotive operation.

Kit for Transformers at Overhead Line Towers

For earthing on fuse carriers
Telescopic earthing stick with adjusting ring (max. 3.5 m long).

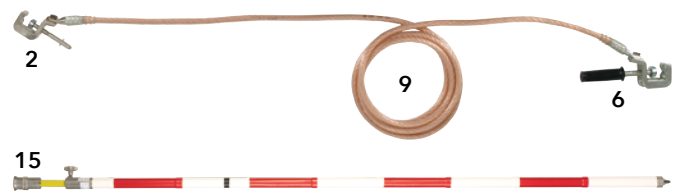

Type BEV ...	US OL ST
Part No.	750 212
Cable cross-section	50 mm ²
Cable length	4000 mm
Max. short-circuit current I _k 0.06 s	34.0 kA
DB drawing No.	3 Ebgw 01.57
DB material No.	237 121

Accessories for Kits for Railway Applications

Canvas bag, empty

With two separate inside pockets and carrier handle.



Type	STT 55 27 30
Part No.	785 111
Dimensions	550 x 270 x 300 mm
Colour	Olive ●

Kit for Supply Lines, Line Feeders, Bypass Lines and other Types of Lines



For earthing the supply line and traction current lines

Telescopic earthing stick with adjusting ring (max. 3.5 m long).

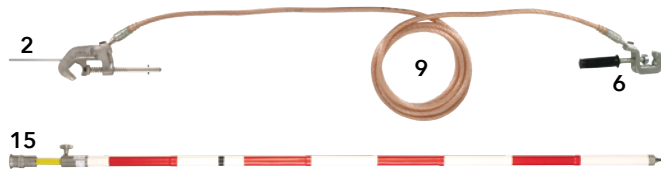

Type BEV ...	SVUL
Part No.	750 213
Cable cross-section	50 mm ²
Cable length	4000 mm
Max. short-circuit current I_k 0.06 s	34.0 kA
DB drawing No.	3 Ebgw 01.57
DB material No.	237 119

Kit for Electric Point and Train Pre-Heating Systems



For the initial equipment of a transformer of electric point and train pre-heating systems.

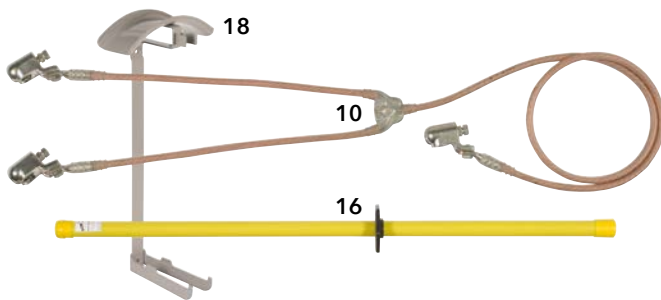

Type BEV ...	WHA ZVA
Part No.	750 215
Cable cross-section	50 mm ²
Cable length	600 / 1800 mm
Max. short-circuit current I_k 0.06 s	34.0 kA
DB drawing No.	3 Ebgw 01.70
DB material No.	742 402

For voltage detectors for electric point heating systems, please refer to the PHE voltage detector chapter.

Accessories for Kits for Railway Applications

Canvas bag for six-part earthing stick

With carrier handle



Type	STT 110 15
Part No.	769 509
Suitable for	EST
Dimensions	Ø150 x 1100 mm
Colour	Olive ●
DB drawing No.	3 Ebgw 01.67

Earthing Sticks for Railway Applications



Attaching a railway earthing device.

For threaded T pin shafts (bayonet locking mechanism)

- For outdoor use
- Robust aluminium cone coupling
- Telescopic stick, length continuously adjustable by star knob
- Only suitable for phase screw clamps and clamps with long T pin shaft

General technical data:

Standard	EN/IEC 61230 (DIN VDE 0683-100)
Temperature range	-25 °C ... +55 °C

Telescopic, with T pin shaft

For threaded T pin shaft (bayonet locking mechanism).



Type	ESTC SQL RW 3500	ESTC SQL RW 5000
Part No.	769 352	769 502
Total length ($l_{G \max}$ / $l_{G \min}$)	3515 / 1935 mm	5015 / 2685 mm
DB drawing No.	3 Ebgw 01.58	3 Ebgw 01.52
DB material No.	157 534	157 533

Telescopic, with T pin shaft and cable entry

For threaded T pin shaft (bayonet locking mechanism).

The coupling is additionally fitted with a cable entry and a hook for securing the earthing cable and earthing stick at the tower (without adjusting ring).



Type	ESTC SQL H RW 5000
Part No.	769 508
Total length ($l_{G \max}$ / $l_{G \min}$)	5015 / 2685 mm
DB drawing No.	3 Ebgw 01.55
DB material No.	612 142

Six-part, with T pin shaft and aluminium coupling

For threaded T pin shafts (bayonet locking mechanism)

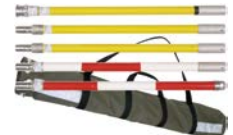

Type	EST SQL RW 4855 TA
Part No.	769 515
Total length ($l_{G \max}$ / $l_{G \min}$)	4855 / 1035 mm
DB drawing No.	3 Ebgw 01.68-1

Phase Connecting Elements for Railway Applications



Coupling the earth clamp to the overhead contact line.

- Safe positive-locking earth clamps for railway applications

Earth Clamp for Overhead Contact Lines

With contact electrode and flexible threaded T pin shaft according to DIN 48087. For AC 80 to AC 120 overhead contact lines.



Type	FEK 4 15 TS FSQL	FEK4 15 TS FSQL AB29
Part No.	784 755	784 756
Clamping range Ø	4 ... 15 mm	4 ... 15 mm
Anti-rotation cable lug	PK2 (Ø10.5 mm)	PK2 (Ø10.5 mm)
For cable material	Cu	Al
For cable cross-section	50 mm ²	70 mm ²
Max. short-circuit current I _k 0.06 s	34.0 kA	32.0 kA
DB drawing No.	3 Ebgw 01.54	Ebgw 01.85
DB material No.	157 536	–

Line Clamp

With contact electrode and threaded T pin shaft according to DIN 48087. For supply and traction power lines.



Type	LK 4 40 TS SQL
Part No.	784 352
Clamping range Ø	4 ... 40 mm
Anti-rotation cable lug	PK2 (Ø10.5 mm)
DB drawing No.	3 Ebgw 01.65
DB material No.	157 539

Earth Connecting Elements for Railway Applications



Clamp for railway tracks mounted on the track profile.

- Safe earth connection elements for railway applications

Clamp for Railway Tracks with Tommy Bar

With detachable tommy bar (locking spring). For profile-free earthing of track profiles S49, S54, S64 and UIC60.



Type	SAK PFE KN	SAK PFE KN AB29
Part No.	792 450	792 451
Anti-rotation cable lug	PK2 (Ø10.5 mm)	PK2 (Ø10.5 mm)
Cable material	Cu	Al
For cable cross-section	50 mm ²	70 mm ²
Max. short-circuit current I _k 0.06 s	34.0 kA	32.0 kA
DB drawing No.	3 Ebgw 01.53 Bl. 1	Ebgw 01.82
DB material No.	157 535	–

Clamp for Railway Tracks with Ratchet

With detachable ratchet. For profile-free earthing of track profiles S49, S54, S64 and UIC60.



Type	SAK PFE ARA	SAK PFE ARA AB29
Part No.	792 455	792 456
Anti-rotation cable lug	PK2 (Ø10.5 mm)	PK2 (Ø10.5 mm)
Cable material	Cu	Al
For cable cross-section	50 mm ²	70 mm ²
Max. short-circuit current I _k 0.06 s	32.0 kA	32.0 kA
DB drawing No.	3 Ebgw 01.53 Bl. 2	3 Ebgw 01.83-1

Universal Clamp, T Pin Shaft

T pin according to DIN 48087.



Universal Clamp with Handle



Type	UK K25 FL30 SQL	UK K25 FL30 HG
Part No.	773 251	774 251
For fixed ball point Ø	25 / 30 mm	25 / 30 mm
Anti-rotation cable lug	PK2 (Ø10.5 mm)	PK2 (Ø10.5 mm)
For cable cross section Cu	50 mm ²	50 mm ²
Max. short-circuit current I _k 0.06 s	34.0 kA	34.0 kA
DB drawing No.	4 Ebgw 01.59	4 Ebgw 01.64
DB material No.	157 538	157 537

Earthing and Short-Circuiting Devices for Railway Applications

Earthing and short-circuiting devices in accordance with EN/IEC 61230 (DIN VDE 0683-100) for earthing and short-circuiting electrical installations at the work location in accordance with EN 50110 (DIN VDE 0105-100).

General technical data:	
Standard	EN/IEC 61230 (DIN VDE 0683-100) and IEC 61138
Temperature range	- 25 °C ... + 55 °C

Parts list:			
No.	Part No.	No.	Part No.
1	Cu 784 755	7	Cu 751 085
1	Al 784 756	7	Al 752 085
2	773 251	8	Cu 751 120
3	784 352	8	Al 752 120
4	Cu 792 450	9	Cu 751 040
4	Al 792 451	9	Al 752 040
5	Cu 792 455	10	750 202
5	Al 792 456	11	740 124
6	774 251		

For more detailed information on these products, see * www.dehn-international.com.

With Earth Clamp for Overhead Contact Lines and Clamp for Railway Tracks with Tommy Bar



Type	EKV K 50 8500	EKV K 50 12000
Part No.	751 086	751 126
Material (cable)	Cu	Cu
Cable cross-section	50 mm ²	50 mm ²
Cable length	8500 mm	12000 mm
Hook	–	–
Max. short-circuit current I _k 0.06 s	34.0 kA	34.0 kA
DB drawing No.	3 Ebgw 01.51/67	3 Ebgw 01.51/67

Type	EKV K H 50 12000	EKV FD K 70 8500AL
Part No.	751 121	752 086
Material (cable)	Cu	Al
Cable cross-section	50 mm ²	70 mm ²
Cable length	12000 mm	8500 mm
Hook	✓	–
Max. short-circuit current I _k 0.06 s	34.0 kA	32.0 kA
DB drawing No.	3 Ebgw 01.51/67	Ebgw 01.74

Type	EKV FD K 70 12000AL	EKV FD K H70 12000AL
Part No.	752 126	752 121
Material (cable)	Al	Al
Cable cross-section	70 mm ²	70 mm ²
Cable length	12000 mm	12000 mm
Hook	–	✓
Max. short-circuit current I _k 0.06 s	32.0 kA	32.0 kA
DB drawing No.	Ebgw 01.74	Ebgw 01.79

With Earth Clamp for Overhead Contact Lines and Clamp for Railway Tracks with Ratchet

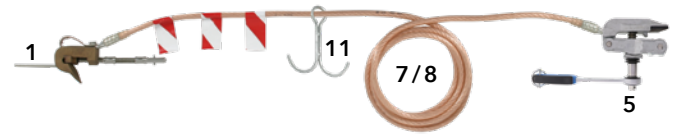

Type	EKV R 50 8500	EKV R 50 12000
Part No.	751 087	751 127
Material (cable)	Cu	Cu
Cable cross-section	50 mm ²	50 mm ²
Cable length	8500 mm	12000 mm
Hook	–	–
Max. short-circuit current I _k 0.06 s	34.0 kA	34.0 kA
DB drawing No.	3 Ebgw 01.51/67	3 Ebgw 01.51/67

Type	EKV R H 50 12000	EKV FD R 70 8500AL
Part No.	751 122	752 087
Material (cable)	Cu	Al
Cable cross-section	50 mm ²	70 mm ²
Cable length	12000 mm	8500 mm
Hook	✓	–
Max. short-circuit current I _k 0.06 s	34.0 kA	32.0 kA
DB drawing No.	3 Ebgw 01.51/67	Ebgw 01.78

Type	EKV FD R 70 12000AL	EKV FD R H70 12000AL
Part No.	752 127	752 122
Material (cable)	Al	Al
Cable cross-section	70 mm ²	70 mm ²
Cable length	12000 mm	12000 mm
Hook	–	✓
Max. short-circuit current I _k 0.06 s	32.0 kA	32.0 kA
DB drawing No.	Ebgw 01.78	Ebgw 01.80

With Universal Clamp (T Pin Shaft) and Universal Clamp (Handle)



Type	EKV UK 50 4000	EKV UKQ UKH70 4000AL
Part No.	750 041	752 041
Material (cable)	Cu	Al
Cable cross-section	50 mm ²	70 mm ²
Cable length	4000 mm	4000 mm
Max. short-circuit current I _k 0.06 s	34.0 kA	32.0 kA
DB drawing No.	3 Ebgw 01.57	Ebgw 01.73

With Conductor Clamp and Universal Clamp (Handle)



Type	EKV LK 50 4000	EKV LK UKH 70 4000AL
Part No.	750 042	752 042
Material (cable)	Cu	Al
Cable cross-section	50 mm ²	70 mm ²
Cable length	4000 mm	4000 mm
Max. short-circuit current I _k 0.06 s	34.0 kA	32.0 kA
DB drawing No.	3 Ebgw 01.57	Ebgw 01.77

With Universal Clamp (Handle) and Clamp for Railway Tracks with Ratchet

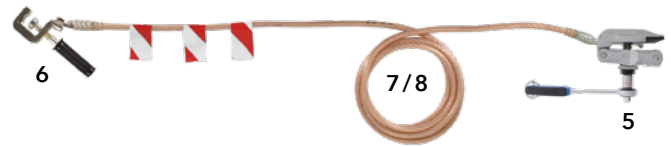

Type	BEV MF SE R	BEV BM HZ BDW R
Part No.	751 196	751 197
Material (cable)	Cu	Cu
Cable cross-section	50 mm ²	50 mm ²
Cable length	8500 mm	12000 mm
Max. short-circuit current I _k 0.06 s	34.0 kA	34.0 kA
DB drawing No.	3 Ebgw 01.56	3 Ebgw 01.56

With Ball Head Caps (Ø25 mm)

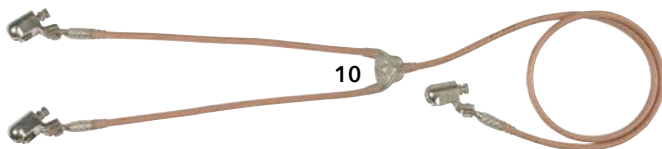

Type	EKV2 50 KKH 600 1800
Part No.	751 150
Material (cable)	Cu
Cable cross-section	50 mm ²
Cable length	600 / 1800 mm
Max. short-circuit current I _k 0.06 s	34.0 kA
DB drawing No.	3 Ebgw 01.70
DB material No.	742 400

Type	BEV UKH R 70 8500AL	BEV UKH R 70 12000AL
Part No.	752 196	752 197
Material (cable)	Al	Al
Cable cross-section	70 mm ²	70 mm ²
Cable length	8500 mm	12000 mm
Max. short-circuit current I _k 0.06 s	32.0 kA	32.0 kA
DB drawing No.	Ebgw 01.76	Ebgw 01.76

With Universal Clamps (Handle) on both sides



Type	BEV MF LTE	BEV 2XUKH 70 8500AL
Part No.	751 192	752 192
Material (cable)	Cu	Al
Cable cross-section	50 mm ²	70 mm ²
Cable length	8500 mm	8500 mm
Max. short-circuit current I _k 0.06 s	34.0 kA	32.0 kA
DB drawing No.	3 Ebgw 01.56	Ebgw 01.72

With Universal Clamp (Handle) and Clamp for Railway Tracks with Tommy Bar



Type	BEV MF SE K	BEV BM HZ BDW K
Part No.	751 191	751 193
Material (cable)	Cu	Cu
Cable cross-section	50 mm ²	50 mm ²
Cable length	8500 mm	12000 mm
Max. short-circuit current I _k 0.06 s	34.0 kA	34.0 kA
DB drawing No.	3 Ebgw 01.56	3 Ebgw 01.56

Type	BEV UKH K 70 8500AL	BEV UKH K 70 12000AL
Part No.	752 191	752 193
Material (cable)	Al	Al
Cable cross-section	70 mm ²	70 mm ²
Cable length	8500 mm	12000 mm
Max. short-circuit current I _k 0.06 s	32.0 kA	32.0 kA
DB drawing No.	Ebgw 01.75	Ebgw 01.75

Accessories for Earthing and Short-Circuiting Devices for Railway Applications

Single-pole EaS cable, copper, unequipped

With red and white marking and cable lug with borehole Ø10.5 mm.



General technical data:

Material	Cu
Crimped cable lug	PK2 (Ø10.5 mm)
Cable cross-section	50 mm ²

Type	EKS 50 BEV 4M	EKS 50 BEV 8.5M
Part No.	751 040	751 085
Cable length	4000 mm	8500 mm
DB material No.	157 511	157 512

Type	EKS 50 BEV 12M	EKS 50 BEV 13M
Part No.	751 120	751 130
Cable length	12000 mm	13000 mm
DB material No.	157 513	–

Type	EKS 50 BEV 14M
Part No.	751 140
Cable length	14000 mm
DB material No.	–

Single-pole EaS cable, aluminium, unequipped

With small red/white marking flags and cable lug with drill hole Ø10.5 mm.



General technical data:

Material	Al
Crimped cable lug design	PK2 (Ø10.5 mm)
Cable cross-section	70 mm ²

Type	EKS B10.5 70 4000AL	EKS B10.5 70 8500AL
Part No.	752 040	752 085
Cable length	4000 mm	8500 mm

Type	EKS B10.5 70 12000AL
Part No.	752 120
Cable length	12000 mm

Suspension hook

For (profile-free) suspension of earthing cables on towers.



Type	EHH BEV OL
Part No.	740 124
DB material No.	778 794

Voltage Limiting Devices



- Electrical isolation of insulated track sections and earthed parts of installations
- Safe equipotential bonding in case of a short-circuit or earth fault at the overhead contact line due to high-current-resistant welding of the electrodes
- Discharge of lightning overvoltages without short-circuit formation due to lightning-resistant SDS ... voltage limiting device
- Short-circuit withstand capability up to 25 kA_{rms} / 100 ms; 36 kA_{rms} / 75 ms

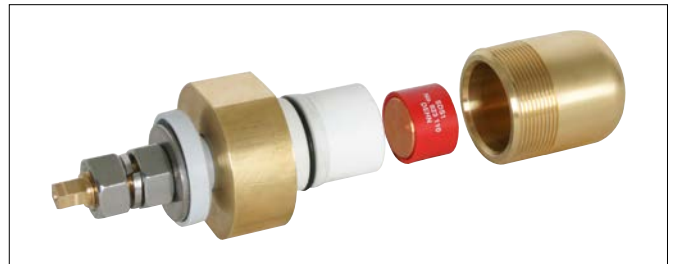

EN 50122-1 describes the use of voltage limiting devices for DC and AC traction systems for so-called "open traction system earthing" of conductive components of the overhead contact line and pantograph zone.

Voltage limiting devices (SDS ...) are used to prevent the occurrence of hazardous surges between the insulated tracks or track sections of electric railways and earthed parts of the installation.

Their function is to permanently connect parts of the installation in the overhead contact line and pantograph zone to the return circuit as soon as the threshold voltage is exceeded.

In case of atmospheric overvoltages, the lightning-resistant SDS ... voltage limiting device is capable of returning to its initial state after discharging the impulse current. Only when the specified lightning current load is exceeded, does a permanent short circuit occur due to high-current-resistant welding of the electrodes, making it necessary to replace the fuse link.

The SDS voltage limiting device consists of a spark gap unit and the respective connecting kit and can be directly connected to the rail or overhead contact line tower.

The spark gap unit of type SDS 1 (Part No. 923 110) developed by DEHN has also been approved by the German Federal Railway Authority (EBA).

SDS 1

Voltage limiting device for a power-frequency sparkover voltage ≤ 940 V.



Type SDS ...	1
Part No.	923 110
VLD type (EN 50122-1)	VLD-F
Power frequency sparkover voltage (U_{aw})	≤ 940 V
DC sparkover voltage (U_{ag})	700 V -14% ... +28%
Impulse sparkover voltage	≤ 1400 V (1 kV/ μ s)
Self-extinguishing capability	300 A / 65 V
Lightning current discharge capacity (10/350 μ s) 0.1x / 0.5x / 1x	5 kA
Lightning current withstand capability (10/350 μ s)	100 kA
Safe short-circuit due to welding of the electrodes in case of alternating currents	≥ 2.5 kA / 1000 V / 30 ms, ≥ 1.5 kA / 1000 V / 100 ms
Safe short-circuit due to welding of the electrodes in case of direct currents	≥ 750 A / 250 ms
Short-circuit withstand capability	25 kA _{rms} / 100 ms; 36 kA _{rms} / 75 ms
Long-term current	1 kA _{rms} for $t \leq 120$ s
Leakage current (I_{lc})	< 1 μ A for 100 V DC
Operating temperature range (T_U)	-40 °C ... +80 °C
To be mounted with mast adapter MA SDS M12 or SIEMENS No. 8WL6503-xx	
Approvals	EBA
DB drawing No.	4 Ebs 15.13.20 Sheet 2

SDS 2

Voltage limiting device for a DC sparkover voltage of 350 V.



Type SDS ...	2
Part No.	923 117
VLD type (EN 50122-1)	VLD-F
DC sparkover voltage (U_{ag})	350 V +/- 20 %
Impulse sparkover voltage	≤ 900 V (1 kV/ μ s)
Lightning current discharge capacity (10/350 μ s) 0.1x / 0.5x / 1x	2 kA
Lightning current withstand capability (10/350 μ s)	25 kA
Safe short-circuit due to welding of the electrodes in case of direct currents	≥ 600 A / 250 ms
Short-circuit withstand capability	25 kA _{rms} / 100 ms; 36 kA _{rms} / 75 ms
Long-term current	1 kA _{rms} for $t \leq 120$ s
Leakage current (I_{lc})	< 1 μ A for 100 V DC
Operating temperature range (T_U)	-40 °C ... +80 °C
To be mounted with mast adapter MA SDS M12 or SIEMENS No. 8WL6503-xx	

SDS 3

Voltage limiting device for a DC sparkover voltage of 550 V.



Type SDS ...	3
Part No.	923 116
VLD type (EN 50122-1)	VLD-F
DC sparkover voltage (U_{ag})	550 V +/- 20 %
Impulse sparkover voltage	≤ 1000 V (1 kV/ μ s)
Lightning current discharge capacity (10/350 μ s) 0.1x / 0.5x / 1x	2.5 kA
Lightning current withstand capability (10/350 μ s)	25 kA
Short-circuit withstand capability	25 kA _{rms} / 100 ms
Operating temperature range (T_U)	-40 °C ... +80 °C
To be mounted with mast adapter MA SDS M12 or SIEMENS Nr. 8WL6503-xx	

SDS 4

Voltage limiting device for a DC sparkover voltage of 230 V.



Type SDS ...	4
Part No.	923 118
VLD type (EN 50122-1)	VLD-F
DC sparkover voltage (U_{ag})	230 V +/- 20%
Impulse sparkover voltage	≤ 650 V (1 kV/ μ s)
Lightning current discharge capacity (10/350 μ s) 0.1x / 0.5x / 1x	2.5 kA
Lightning current withstand capability (10/350 μ s)	25 kA
Impulse current discharge capacity (8/20 μ s) 0.1x / 0.5x / 1x	20 kA
Safe short-circuit due to welding of the electrodes in case of direct currents	≥ 600 A / 250 ms
Short-circuit withstand capability	25 kA _{rms} / 100 ms; 36 kA _{rms} / 75 ms
Long-term current	1 kA _{rms} for $t \leq 120$ s
Leakage current (I_{lc})	< 1 μ A for 100 V DC
Operating temperature range (T_U)	-40 °C ... +80 °C
To be mounted with mast adapter MA SDS M12 or SIEMENS No. 8WL6503-xx	

SDS 5

Voltage limiting device for a DC sparkover voltage of 120 V.



Type SDS ...	5
Part No.	923 119
VLD type (EN 50122-1)	VLD-F
DC sparkover voltage (U_{ag})	120 V +/- 20 %
Impulse sparkover voltage	≤ 600 V (1 kV/ μ s)
Lightning current discharge capacity (10/350 μ s) 0.1x / 0.5x / 1x	2 kA
Lightning current withstand capability (10/350 μ s)	25 kA
Impulse current discharge capacity (8/20 μ s) 0.1x / 0.5x / 1x	20 kA
Safe short-circuit due to welding of the electrodes in case of direct currents	≥ 600 A / 250 ms
Short-circuit withstand capability	25 kA _{rms} / 100 ms; 36 kA _{rms} / 75 ms
Long-term current	1 kA _{rms} for $t \leq 120$ s
Leakage current (I_{lc})	< 1 μ A for 100 V DC
Operating temperature range (T_U)	-40 °C ... +80 °C
To be mounted with mast adapter MA SDS M12 or SIEMENS No. 8WL6503-xx	

Accessories for Voltage Limiting Devices

Mast adapter for SDS voltage-limiting devices

For mounting on the mast support profile of a contact wire mast with FI 8-12 mm.



Type	MA SDS M12
Part No.	723 199
Lightning current carrying capability (10/350 μ s)	25 kA
Short-circuit withstand capability	21 kA _{rms} / 30 ms
Long-term current	1 kA _{rms} at $t \leq 120$ s
Leakage current (I_{lc})	< 1 μ A at 100 V DC
Dimensions of the threaded pin	M12
Material	Brass
Degree of protection of the inner enclosure	IP 67

Part No.	GTIN*	PG	Weight	PU	SU	Page	Part No.	GTIN*	PG	Weight	PU	SU	Page
336 020	003941	05 00 04 01	118 g	1	pc(s)	65	715 314	132474	05 00 04 08	1.61 kg	1	pc(s)	72
336 025	003958	05 00 04 01	252 g	1	pc(s)	65	715 315	135338	05 00 04 08	1.60 kg	1	pc(s)	72
524 910	039339	01 50 50 01	2 g	1	pc(s)	66	716 001	010406	05 00 04 02	184 g/m	1	m	68
524 912	039360	01 06 01 01	4 g	1	pc(s)	66	723 199	151703	05 03 01 01	750 g	1	pc(s)	172
524 913	053250	01 06 01 01	8 g	1	pc(s)	66	725 001	011793	05 00 04 02	207 g/m	1	m	68
525 001	004986	05 00 04 50	19 g	10	pc(s)	66	725 010	003750	05 00 04 01	410 g	1	pc(s)	63
525 002	004993	05 00 04 50	37 g	10	pc(s)	66	725 012	003767	05 00 04 01	400 g	1	pc(s)	63
525 910	390911	01 50 50 01	3 g	1	pc(s)	66	725 014	003774	05 00 04 01	385 g	1	pc(s)	63
525 912	053267	01 50 50 01	5 g	1	pc(s)	66	725 016	003781	05 00 04 01	365 g	1	pc(s)	63
525 916	053274	01 06 01 01	10 g	1	pc(s)	66	725 018	078048	05 00 04 01	345 g	1	pc(s)	63
561 924	047280	01 50 50 01	26 g	1	pc(s)	66	725 020	003804	05 00 04 01	320 g	1	pc(s)	63
561 925	056244	01 06 01 01	35 g	1	pc(s)	66	728 312	128712	05 00 04 08	270 g	1	pc(s)	74
561 930	053298	01 06 01 01	39 g	1	pc(s)	66	728 313	157132	05 00 04 08	612 g	1	pc(s)	74
561 931	053311	01 06 01 01	77 g	1	pc(s)	66	728 501	079618	05 00 04 07	900 g	1	pc(s)	165
561 935	056053	01 06 01 01	42 g	1	pc(s)	66	728 502	079571	05 00 04 07	708 g	1	pc(s)	165
644 000	030268	03 07 01 01	4.45 kg	1	pc(s)	74	728 503	079564	05 00 04 07	453 g	1	pc(s)	165
700 000	004122	05 05 01 06	1.16 kg	1	pc(s)	55	728 516	147898	05 00 04 09	1.44 kg	1	pc(s)	67
700 000	004122	05 05 01 06	1.16 kg	1	pc(s)	91	728 522	147874	05 00 04 09	676 g	1	pc(s)	67
700 002	004139	05 05 01 06	1.15 kg	1	pc(s)	55	728 526	147881	05 00 04 09	934 g	1	pc(s)	67
700 002	004139	05 05 01 06	1.15 kg	1	pc(s)	91	728 620	147843	05 00 04 09	985 g	1	pc(s)	67
700 003	004146	05 05 01 06	700 g	1	pc(s)	55	728 625	147867	05 00 04 09	984 g	1	pc(s)	67
700 003	004146	05 05 01 06	700 g	1	pc(s)	91	735 001	011847	05 00 04 02	366 g/m	1	m	68
700 004	004153	05 05 01 06	1.00 kg	1	pc(s)	27	740 124	051072	05 00 04 06	255 g	1	pc(s)	171
700 005	004160	05 05 01 06	707 g	1	pc(s)	27	745 016	052000	05 00 04 13	467 g	1	pc(s)	87
700 006	004177	05 05 01 06	780 g	1	pc(s)	55	745 017	052017	05 00 04 13	277 g	1	pc(s)	87
700 006	004177	05 05 01 06	780 g	1	pc(s)	91	745 018	052048	05 00 04 13	271 g	1	pc(s)	87
700 007	004184	05 05 01 06	780 g	1	pc(s)	55	745 021	155336	05 00 04 13	289 g	1	pc(s)	88
700 007	004184	05 05 01 06	780 g	1	pc(s)	91	745 022	353138	05 00 04 13	114 g	3	pc(s)	87
700 008	004191	05 05 01 06	803 g	1	pc(s)	55	745 105	104457	05 00 04 15	1.83 kg	1	pc(s)	90
700 008	004191	05 05 01 06	803 g	1	pc(s)	91	745 106	104495	05 05 01 02	890 g	1	pc(s)	90
700 014	007208	05 05 01 06	1.71 kg	1	pc(s)	27	745 107	104501	05 00 04 15	286 g	1	pc(s)	90
700 015	007192	05 05 01 06	1.41 kg	1	pc(s)	27	745 108	104518	05 00 04 15	20 g	1	pc(s)	90
700 058	511682	05 00 02 02	5 g	1	mm	30	745 109	104525	05 00 04 15	18 g	1	pc(s)	90
700 059	511699	05 00 02 02	172 g	1	mm	30	745 115	155299	05 00 04 15	296 g	1	pc(s)	90
700 060	511705	05 00 02 02	348 g	1	mm	30	745 121	268418	05 00 04 15	415 g	1	pc(s)	90
700 098	157422	05 00 02 03	180 g/kit	1	kit	29	745 201	008007	05 00 04 15	65 g	1	pc(s)	88
700 099	157415	05 00 02 03	1.28 g/mm	1	mm	29	745 202	007871	05 00 04 15	90 g	1	pc(s)	88
700 100	500280	05 00 03 09	318 g	1	pc(s)	46	745 203	008014	05 00 04 15	102 g	1	pc(s)	88
700 102	500297	05 00 03 09	345 g	1	pc(s)	46	745 204	018655	05 00 04 15	145 g	1	pc(s)	88
700 110	501546	05 00 02 03	18.74 kg	1	pc(s)	30	745 302	052024	05 00 04 15	110 g	1	pc(s)	87
700 111	502055	05 00 02 03	19.93 kg	1	pc(s)	30	745 307	155404	05 00 04 15	116 g	1	pc(s)	87
700 112	502062	05 00 02 03	660 g	1	pc(s)	30	745 400	006959	05 00 04 13	250 g	1	pc(s)	88
700 113	502079	05 00 02 03	680 g	1	pc(s)	30	745 414	116085	05 00 04 11	285 g	1	pc(s)	91
700 120	501560	05 01 01 05	15 g	1	pc(s)	98	745 415	116092	05 00 04 11	275 g	1	pc(s)	91
700 121	501577	05 01 01 05	20 g	1	pc(s)	98	745 500	007888	05 00 04 13	7.57 kg	1	pc(s)	86
700 122	501584	05 01 01 05	29 g	1	pc(s)	98	745 502	072213	05 00 04 13	360 g	1	pc(s)	88
705 500	000025	05 00 04 50	122 g	1	pc(s)	65	745 503	133570	05 00 04 12	154 g	1	pc(s)	85
705 501	003927	05 00 04 01	152 g	1	pc(s)	65	745 506	307667	05 00 04 13	114 g	1	pc(s)	88
705 504	008021	05 00 04 50	183 g	5	pc(s)	65	745 508	149366	05 00 04 13	137 g	1	pc(s)	88
705 510	089587	05 00 04 50	240 g	1	pc(s)	65	745 509	149915	05 00 04 13	127 g	1	pc(s)	90
706 200	004276	05 00 04 01	172 g	1	pc(s)	64	745 510	155671	05 00 04 13	225 g	1	pc(s)	85
706 235	004290	05 00 04 01	219 g	1	pc(s)	64	745 602	072220	05 00 04 13	406 g	1	pc(s)	88
706 239	155145	05 00 04 01	227 g	1	pc(s)	64	745 900	082731	05 05 01 01	3.71 kg	1	pc(s)	84
706 300	003675	05 00 04 01	129 g	1	pc(s)	63	745 900	082731	05 05 01 01	3.71 kg	1	pc(s)	92
706 600	004283	05 00 04 01	158 g	1	pc(s)	64	745 901	083530	05 00 04 12	6.89 kg	1	pc(s)	84
706 645	004306	05 00 04 01	274 g	1	pc(s)	64	745 902	093591	05 05 01 02	1.62 kg	1	pc(s)	84
707 200	004368	05 00 04 01	204 g	1	pc(s)	64	745 902	093591	05 05 01 02	1.62 kg	1	pc(s)	92
707 235	004382	05 00 04 01	259 g	1	pc(s)	64	745 903	093577	05 00 04 12	7.00 kg	1	pc(s)	84
707 600	004375	05 00 04 01	191 g	1	pc(s)	64	745 905	082021	05 00 04 12	75 g	1	pc(s)	85
707 645	004399	05 00 04 01	299 g	1	pc(s)	64	745 910	082038	05 00 04 12	190 g	1	pc(s)	85
712 001	011823	05 00 04 02	1.23 kg/m	1	m	68	745 915	082045	05 00 04 12	420 g	1	pc(s)	85
715 001	011830	05 00 04 02	1.52 kg/m	1	m	68	745 921	082069	05 00 04 12	216 g	1	pc(s)	85
715 312	150386	05 00 04 08	1.50 kg	1	pc(s)	72	745 921	082069	05 00 04 12	216 g	1	pc(s)	88
715 313	154971	05 00 04 08	1.55 kg	1	pc(s)	72	745 921	082069	05 00 04 12	216 g	1	pc(s)	90
							745 922	082434	05 00 04 12	220 g	1	pc(s)	85
							745 952	137066	05 05 01 02	4.90 kg	1	pc(s)	84
							745 952	137066	05 05 01 02	4.90 kg	1	pc(s)	86

Part No.	GTIN*	PG	Weight	PU	SU	Page	Part No.	GTIN*	PG	Weight	PU	SU	Page
745 952	137066	05 05 01 02	4.90 kg	1	pc(s)	92	756 200	004313	05 00 04 01	357 g	1	pc(s)	64
745 953	137073	05 05 01 02	4.95 kg	1	pc(s)	92	756 245	004337	05 00 04 01	434 g	1	pc(s)	64
750 001	011809	05 00 04 02	535 g/m	1	m	68	756 300	003682	05 00 04 01	212 g	1	pc(s)	63
750 041	126688	05 00 04 06	4.22 kg	1	pc(s)	169	756 600	004320	05 00 04 01	356 g	1	pc(s)	64
750 042	126695	05 00 04 06	3.89 kg	1	pc(s)	170	756 645	004344	05 00 04 01	470 g	1	pc(s)	64
750 196	123823	05 00 04 06	26.58 kg	1	pc(s)	166	757 200	004405	05 00 04 01	395 g	1	pc(s)	64
750 200	123830	05 00 04 06	16.95 kg	1	pc(s)	166	757 245	004429	05 00 04 01	454 g	1	pc(s)	64
750 210	123793	05 00 04 06	13.44 kg	1	pc(s)	165	757 600	004412	05 00 04 01	370 g	1	pc(s)	64
750 211	123809	05 00 04 06	15.55 kg	1	pc(s)	165	757 645	004436	05 00 04 01	491 g	1	pc(s)	64
750 212	123847	05 00 04 06	13.00 kg	1	pc(s)	166	758 001	004030	05 00 04 16	2.21 kg	1	pc(s)	57
750 213	123861	05 00 04 06	8.76 kg	1	pc(s)	167	758 003	004047	05 00 04 16	1.95 kg	1	pc(s)	57
750 214	123816	05 00 04 06	15.60 kg	1	pc(s)	166	758 015	041608	05 00 04 16	2.62 kg	1	pc(s)	57
750 215	123878	05 00 04 06	7.30 kg	1	pc(s)	167	758 020	098992	05 00 04 16	1.34 kg	1	pc(s)	57
750 216	157255	05 00 04 06	26.58 kg	1	pc(s)	166	758 021	099005	05 00 04 16	1.10 kg	1	pc(s)	57
750 217	157262	05 00 04 06	17.08 kg	1	pc(s)	166	758 022	099012	05 00 04 16	650 g	1	pc(s)	57
750 218	157224	05 00 04 06	14.73 kg	1	pc(s)	165	758 025	127838	05 00 04 16	1.49 kg	1	pc(s)	57
750 219	157231	05 00 04 06	16.87 kg	1	pc(s)	165	758 028	132450	05 00 04 16	4.16 kg	1	pc(s)	58
750 221	157248	05 00 04 06	15.51 kg	1	pc(s)	166	758 036	133884	05 00 04 16	203 g	1	pc(s)	58
750 500	000032	05 00 04 01	250 g	1	pc(s)	65	758 075	247789	05 00 04 16	1.08 kg	1	pc(s)	58
751 040	006041	05 00 04 02	2.60 kg	1	pc(s)	171	758 085	247819	05 00 04 16	750 g	1	pc(s)	58
751 085	006058	05 00 04 02	4.98 kg	1	pc(s)	171	758 095	247826	05 00 04 16	1.32 kg	1	pc(s)	58
751 086	126626	05 00 04 06	8.99 kg	1	pc(s)	169	758 099	287587	05 00 04 16	3.06 kg	1	pc(s)	58
751 087	126633	05 00 04 06	9.13 kg	1	pc(s)	169	758 116	247918	05 00 04 16	220 g	1	pc(s)	58
751 120	006065	05 00 04 02	6.86 kg	1	pc(s)	171	758 125	247925	05 00 04 16	260 g	1	pc(s)	58
751 121	126640	05 00 04 06	11.14 kg	1	pc(s)	169	758 135	247932	05 00 04 16	301 g	1	pc(s)	58
751 122	126657	05 00 04 06	11.41 kg	1	pc(s)	169	758 216	247949	05 00 04 16	282 g	1	pc(s)	58
751 126	126664	05 00 04 06	10.88 kg	1	pc(s)	169	759 706	259232	05 00 03 11	1.24 kg	1	pc(s)	48
751 127	126671	05 00 04 06	11.01 kg	1	pc(s)	169	759 712	259256	05 00 03 11	1.24 kg	1	pc(s)	48
751 130	041776	05 00 04 02	7.39 kg	1	pc(s)	171	759 716	259270	05 00 03 11	1.52 kg	1	pc(s)	48
751 140	018570	05 00 04 02	7.93 kg	1	pc(s)	171	759 736	259263	05 00 03 11	1.46 kg	1	pc(s)	48
751 150	084520	05 00 04 06	4.53 kg	1	pc(s)	170	759 798	259317	05 00 03 50	2 g	1	pc(s)	99
751 191	126602	05 00 04 06	8.82 kg	1	pc(s)	170	759 799	259294	05 00 03 50	32 g	1	pc(s)	99
751 192	123885	05 00 04 06	6.68 kg	1	pc(s)	170	761 001	125179	05 00 04 11	525 g	1	pc(s)	77
751 193	123892	05 00 04 06	10.28 kg	1	pc(s)	170	761 002	125186	05 00 04 11	400 g	1	pc(s)	78
751 196	157767	05 00 04 06	8.53 kg	1	pc(s)	170	761 003	134348	05 00 04 11	830 g	1	pc(s)	77
751 197	157774	05 00 04 06	14.41 kg	1	pc(s)	170	761 004	134355	05 00 04 11	853 g	1	pc(s)	78
752 040	230187	05 00 04 03	1.09 kg	1	pc(s)	171	761 010	000155	05 00 04 11	980 g	1	pc(s)	77
752 041	230569	05 00 04 05	3.18 kg	1	pc(s)	169	761 011	000230	05 00 04 11	1.05 kg	1	pc(s)	77
752 042	230576	05 00 04 05	3.57 kg	1	pc(s)	170	761 015	000162	05 00 04 11	1.35 kg	1	pc(s)	77
752 085	230637	05 00 04 03	2.32 kg	1	pc(s)	171	761 016	000247	05 00 04 11	1.36 kg	1	pc(s)	77
752 086	230217	05 00 04 07	7.02 kg	1	pc(s)	169	761 070	136212	05 00 04 11	800 g	1	pc(s)	78
752 087	230422	05 00 04 07	7.33 kg	1	pc(s)	169	761 075	136229	05 00 04 11	800 g	1	pc(s)	78
752 120	230644	05 00 04 03	3.28 kg	1	pc(s)	171	763 100	125155	05 00 01 02	600 g	1	pc(s)	26
752 121	230316	05 00 04 07	8.32 kg	1	pc(s)	169	763 111	137226	05 00 01 02	580 g	1	pc(s)	26
752 122	230453	05 00 04 07	8.48 kg	1	pc(s)	169	763 211	081567	05 00 05 01	8.00 kg	1	pc(s)	95
752 126	230262	05 00 04 07	8.05 kg	1	pc(s)	169	763 221	081574	05 00 05 01	8.00 kg	1	pc(s)	95
752 127	230439	05 00 04 07	8.21 kg	1	pc(s)	169	763 231	081581	05 00 05 01	8.00 kg	1	pc(s)	95
752 191	230330	05 00 04 07	6.34 kg	1	pc(s)	170	763 241	081598	05 00 05 01	8.00 kg	1	pc(s)	95
752 192	230590	05 00 04 07	4.66 kg	1	pc(s)	170	763 610	003286	05 00 01 02	962 g	1	pc(s)	26
752 193	230538	05 00 04 07	7.38 kg	1	pc(s)	170	763 611	076921	05 00 01 02	610 g	1	pc(s)	26
752 196	230545	05 00 04 07	6.52 kg	1	pc(s)	170	763 612	078635	05 00 01 02	800 g	1	pc(s)	26
752 197	230552	05 00 04 07	7.55 kg	1	pc(s)	170	763 615	003309	05 00 01 02	1.42 kg	1	pc(s)	26
754 200	004207	05 00 04 01	131 g	1	pc(s)	63	763 620	003316	05 00 01 02	800 g	1	pc(s)	26
754 205	097865	05 00 04 01	137 g	1	pc(s)	63	763 630	003330	05 00 01 02	1.35 kg	1	pc(s)	26
754 235	004221	05 00 04 01	184 g	1	pc(s)	63	763 710	098558	05 00 01 01	1.20 kg	1	pc(s)	28
754 238	131309	05 00 04 01	180 g	1	pc(s)	63	763 711	098565	05 00 01 01	442 g	1	pc(s)	28
754 600	004214	05 00 04 01	116 g	1	pc(s)	63	763 712	098572	05 00 01 01	49 g	1	pc(s)	28
754 645	004238	05 00 04 01	287 g	1	pc(s)	63	765 001	051805	05 00 04 11	190 g	1	pc(s)	78
755 200	000087	05 00 04 01	220 g	1	pc(s)	63	765 001	051805	05 00 04 11	190 g	1	pc(s)	83
755 225	004498	05 00 04 01	265 g	1	pc(s)	63	765 005	051775	05 00 01 02	117 g	1	pc(s)	22
755 245	000070	05 00 04 01	278 g	1	pc(s)	63	765 005	051775	05 00 01 02	117 g	1	pc(s)	100
755 501	003934	05 00 04 01	298 g	1	pc(s)	65	765 006	156104	05 00 04 11	315 g	1	pc(s)	79
755 600	000094	05 00 04 01	204 g	1	pc(s)	63	765 009	051782	05 00 01 02	145 g	1	pc(s)	23
755 626	079625	05 00 04 01	301 g	1	pc(s)	164	765 009	051782	05 00 01 02	145 g	1	pc(s)	100
755 627	077768	05 00 04 01	311 g	1	pc(s)	164	765 040	093751	05 00 01 03	2.13 kg	1	pc(s)	27
755 636	079670	05 00 04 01	310 g	1	pc(s)	164	765 041	093768	05 00 01 03	2.28 kg	1	pc(s)	27
755 645	000100	05 00 04 01	319 g	1	pc(s)	63	765 042	093775	05 00 01 03	2.59 kg	1	pc(s)	27
755 646	079632	05 00 04 01	330 g	1	pc(s)	164	765 050	093782	05 00 01 03	2.15 kg	1	pc(s)	27

Part No.	GTIN*	PG	Weight	PU	SU	Page	Part No.	GTIN*	PG	Weight	PU	SU	Page
765 051	093799	05 00 01 03	2.29 kg	1	pc(s)	27	766 368	115026	05 00 01 01	340 g	1	pc(s)	101
765 052	093805	05 00 01 03	2.59 kg	1	pc(s)	27	766 369	125025	05 00 01 01	388 g	1	pc(s)	101
766 001	017825	05 00 01 01	416 g	1	pc(s)	22	766 371	139909	05 00 01 01	560 g	1	pc(s)	154
766 002	017832	05 00 01 01	810 g	1	pc(s)	22	766 372	139916	05 00 01 01	1.24 kg	1	pc(s)	154
766 036	105584	05 05 01 02	968 g	1	pc(s)	56	766 380	400863	05 00 01 01	6.67 kg	1	pc(s)	25
766 037	125940	05 00 01 01	6.56 kg	1	pc(s)	39	766 380	400863	05 00 01 01	6.67 kg	1	pc(s)	155
766 037	125940	05 00 01 01	6.56 kg	1	pc(s)	101	766 389	411838	05 00 01 05	79 g	1	pc(s)	25
766 038	105355	05 00 01 01	275 g	1	pc(s)	101	766 392	282902	05 00 01 05	78 g	1	pc(s)	25
766 039	105362	05 05 01 04	712 g	1	pc(s)	101	766 393	282926	05 00 01 05	153 g	1	pc(s)	24
766 040	113046	05 00 01 04	820 g	1	pc(s)	26	766 396	307056	05 00 01 05	123 g	1	pc(s)	25
766 041	113053	05 00 01 04	1.02 kg	1	pc(s)	26	766 456	121812	05 00 01 50	690 g	1	pc(s)	25
766 042	113060	05 00 01 04	1.12 kg	1	pc(s)	26	766 456	121812	05 00 01 50	690 g	1	pc(s)	102
766 043	510142	05 00 01 04	---	1	pc(s)	26	766 466	121805	05 00 01 50	900 g	1	pc(s)	25
766 049	108059	05 00 01 01	165 g	1	pc(s)	101	766 466	121805	05 00 01 50	900 g	1	pc(s)	102
766 055	125063	05 00 01 01	120 g	1	pc(s)	102	766 469	139893	05 00 01 01	3.42 kg	1	pc(s)	154
766 056	125070	05 00 01 01	204 g	1	pc(s)	155	766 480	511835	05 50 50 01	---	1	pc(s)	24
766 057	125087	05 00 01 50	10 pc(s)/kit	1	kit	155	766 480	511835	05 50 50 01	---	1	pc(s)	154
766 059	378681	05 00 01 01	110 g	1	pc(s)	155	766 483	513921	05 00 01 05	---	1	pc(s)	24
766 073	126121	05 00 03 50	1.60 kg	1	pc(s)	102	766 483	513921	05 00 01 05	---	1	pc(s)	154
766 076	120464	05 00 04 11	770 g	1	pc(s)	102	766 520	136243	05 00 04 11	306 g	1	pc(s)	102
766 077	120457	05 00 04 11	730 g	1	pc(s)	102	766 542	051706	05 00 03 09	71 g	1	pc(s)	45
766 100	125117	05 00 01 01	400 g	1	pc(s)	22	766 543	051683	05 05 01 03	148 g	1	pc(s)	45
766 105	125988	05 00 03 50	10 g	1	pc(s)	101	766 601	056596	05 05 01 03	319 g	1	pc(s)	56
766 111	137295	05 00 01 01	560 g	1	pc(s)	22	766 602	056626	05 05 01 03	1.31 kg	1	pc(s)	56
766 115	136038	05 00 01 50	725 g	1	pc(s)	102	766 602	056626	05 05 01 03	1.31 kg	1	pc(s)	164
766 116	153073	05 00 01 01	1.05 kg	1	pc(s)	102	766 605	054370	05 50 50 01	2 g	1	pc(s)	99
766 117	153080	05 00 01 01	645 g	1	pc(s)	102	766 611	146549	05 00 03 50	4 pc(s)/kit	1	kit	99
766 120	136052	05 00 01 50	690 g	1	pc(s)	102	766 614	056916	05 05 01 03	600 g	1	pc(s)	164
766 122	134249	05 00 01 01	800 g	1	pc(s)	22	766 616	126091	05 00 03 02	5.09 kg	1	pc(s)	156
766 164	121751	05 00 01 02	400 g	1	pc(s)	23	766 617	101760	05 00 03 02	4.95 kg	1	pc(s)	156
766 164	121751	05 00 01 02	400 g	1	pc(s)	100	766 618	148277	05 00 03 50	23 g	1	pc(s)	99
766 169	230675	05 00 01 02	550 g	1	pc(s)	100	766 660	302464	05 00 03 09	460 g	1	pc(s)	45
766 298	007864	05 05 01 01	3.70 kg	1	pc(s)	86	766 665	302488	05 00 03 09	460 g	1	pc(s)	45
766 298	007864	05 05 01 01	3.70 kg	1	pc(s)	92	766 704	069749	05 05 01 04	720 g	1	pc(s)	164
766 300	007628	05 05 01 01	1.20 kg	1	pc(s)	86	766 706	094307	05 00 03 07	800 g	1	pc(s)	39
766 300	007628	05 05 01 01	1.20 kg	1	pc(s)	92	766 710	094314	05 00 03 07	1.70 kg	1	pc(s)	39
766 301	125124	05 00 01 01	400 g	1	pc(s)	23	766 720	094321	05 00 03 07	1.70 kg	1	pc(s)	39
766 302	051317	05 00 04 13	4.38 kg	1	pc(s)	86	766 888	125209	05 00 03 50	63 g	1	pc(s)	55
766 310	137318	05 00 01 01	560 g	1	pc(s)	23	766 889	125193	05 00 03 50	172 g	1	pc(s)	55
766 311	017856	05 00 01 01	419 g	1	pc(s)	22	766 913	051836	05 00 03 50	42 g	1	pc(s)	54
766 311	017856	05 00 01 01	419 g	1	pc(s)	25	766 915	088207	05 00 03 50	220 g	1	pc(s)	54
766 312	311985	05 00 01 01	540 g	1	pc(s)	22	766 916	106840	05 00 03 50	125 g	1	pc(s)	54
766 313	115040	05 00 01 50	413 g	1	pc(s)	55	766 923	074590	05 00 03 50	71 g	1	pc(s)	54
766 315	008281	05 00 01 01	820 g	1	pc(s)	22	766 924	094840	05 00 03 50	46 g	1	pc(s)	54
766 315	008281	05 00 01 01	820 g	1	pc(s)	25	766 925	091672	05 00 03 50	10 g	1	pc(s)	54
766 321	129528	05 00 01 50	187 g	1	pc(s)	23	766 927	097452	05 00 03 50	12 g	1	pc(s)	54
766 322	134256	05 00 01 01	800 g	1	pc(s)	23	766 940	080485	05 00 03 50	145 g	1	pc(s)	54
766 322	134256	05 00 01 01	800 g	1	pc(s)	25	766 941	080478	05 00 03 50	150 g	1	pc(s)	54
766 328	135765	05 00 01 01	283 g	1	pc(s)	101	766 950	090668	05 00 03 50	339 g	1	pc(s)	54
766 331	115002	05 00 01 01	375 g	1	pc(s)	101	766 960	109629	05 00 03 50	310 g	1	pc(s)	54
766 332	137325	05 00 01 01	2.38 kg	1	pc(s)	23	766 994	247062	05 05 01 02	3.31 kg	1	pc(s)	56
766 335	115033	05 00 01 50	420 g	1	pc(s)	25	766 995	247147	05 05 01 02	4.38 kg	1	pc(s)	56
766 335	115033	05 00 01 50	420 g	1	pc(s)	102	766 996	128170	05 05 01 03	4.00 kg	1	pc(s)	56
766 340	125056	05 00 01 01	3.00 kg	1	pc(s)	155	766 998	115286	05 05 01 02	3.36 kg	1	pc(s)	56
766 352	136069	05 00 01 50	250 g	1	pc(s)	102	767 101	069541	05 00 03 12	60 g	1	pc(s)	50
766 356	121799	05 00 01 50	400 g	1	pc(s)	25	767 102	074064	05 00 03 12	62 g	1	pc(s)	50
766 356	121799	05 00 01 50	400 g	1	pc(s)	102	767 107	105577	05 05 01 02	880 g	1	pc(s)	56
766 358	136137	05 00 01 50	200 g	1	pc(s)	102	767 110	070905	05 00 03 12	119 g	1	pc(s)	50
766 359	134379	05 00 01 50	200 g	1	pc(s)	24	767 112	074361	05 00 03 12	150 g	1	pc(s)	51
766 359	134379	05 00 01 50	200 g	1	pc(s)	102	767 122	074385	05 00 03 12	185 g	1	pc(s)	51
766 362	230705	05 00 01 01	635 g	1	pc(s)	23	767 125	130319	05 00 03 01	1.26 kg	1	pc(s)	157
766 362	230705	05 00 01 01	635 g	1	pc(s)	101	767 131	139411	05 00 03 01	6.20 kg	1	pc(s)	159
766 363	121737	05 00 01 01	600 g	1	pc(s)	23	767 132	073005	05 00 03 12	640 g	1	pc(s)	52
766 363	121737	05 00 01 01	600 g	1	pc(s)	101	767 133	073494	05 00 03 12	85 g	1	pc(s)	53
766 364	128262	05 00 01 01	240 g	1	pc(s)	23	767 136	081109	05 00 03 12	65 g	1	pc(s)	53
766 364	128262	05 00 01 01	240 g	1	pc(s)	100	767 139	136953	05 00 03 12	820 g	1	pc(s)	53
766 365	121768	05 00 01 01	200 g	1	pc(s)	23	767 150	139473	05 00 03 12	1.94 kg	1	pc(s)	52
766 365	121768	05 00 01 01	200 g	1	pc(s)	100	767 413	128750	05 00 03 02	1.77 kg	1	pc(s)	158
766 366	121782	05 00 01 50	600 g	1	pc(s)	25	767 415	081116	05 00 03 02	1.52 kg	1	pc(s)	158
766 366	121782	05 00 01 50	600 g	1	pc(s)	102	767 416	084247	05 00 03 02	2.62 kg	1	pc(s)	158
766 367	137042	05 00 01 01	600 g	1	pc(s)	23	767 500	105676	05 05 01 03	280 g	1	pc(s)	53
766 367	137042	05 00 01 01	600 g	1	pc(s)	101	767 539	306769	05 00 03 06	1.40 kg	1	pc(s)	42
766 368	115026	05 00 01 01	340 g	1	pc(s)	39	767 541	115712	05 00 03 06	1.20 kg	1	pc(s)	42

Part No.	GTIN*	PG	Weight	PU	SU	Page	Part No.	GTIN*	PG	Weight	PU	SU	Page
767 542	086616	05 00 03 06	5.35 kg	1	pc(s)	161	769 352	007345	05 00 04 11	3.70 kg	1	pc(s)	167
767 547	158276	05 00 03 06	2.00 kg	1	pc(s)	43	769 400	080881	05 00 04 11	3.37 kg	1	pc(s)	79
767 552	115736	05 00 03 06	2.00 kg	1	pc(s)	43	769 500	080904	05 00 04 11	3.92 kg	1	pc(s)	79
767 565	143760	05 00 03 06	2.03 kg	1	pc(s)	160	769 502	004542	05 00 04 11	4.54 kg	1	pc(s)	167
767 571	124967	05 00 03 06	1.99 kg	1	pc(s)	41	769 503	003996	05 00 04 11	1.65 kg	1	pc(s)	79
767 572	124974	05 00 03 06	2.01 kg	1	pc(s)	41	769 504	004559	05 00 04 11	1.66 kg	1	pc(s)	79
767 573	134270	05 00 03 06	3.57 kg	1	pc(s)	41	769 505	004566	05 00 04 11	1.46 kg	1	pc(s)	79
767 574	125971	05 05 01 03	500 g	1	pc(s)	56	769 508	052383	05 00 04 11	4.50 kg	1	pc(s)	166
767 610	135208	05 00 03 08	4.40 kg	1	pc(s)	163	769 509	068230	05 05 01 04	358 g	1	pc(s)	167
767 614	135307	05 00 03 08	6.00 kg	1	pc(s)	163	769 511	135055	05 00 04 11	4.41 kg	1	pc(s)	73
767 636	155886	05 00 03 08	2.31 kg	1	pc(s)	44	769 515	157361	05 00 04 11	6.01 kg	1	pc(s)	167
767 636	155886	05 00 03 08	2.31 kg	1	pc(s)	162	769 701	242470	05 00 03 01	750 g	1	pc(s)	100
767 637	155879	05 00 03 08	2.10 kg	1	pc(s)	44	769 712	242517	05 00 03 01	5.23 kg	1	pc(s)	40
767 637	155879	05 00 03 08	2.10 kg	1	pc(s)	163	769 714	246768	05 00 03 01	2.80 kg	1	pc(s)	159
767 639	155817	05 00 03 08	2.40 kg	1	pc(s)	163							
767 640	155978	05 00 03 08	2.10 kg	1	pc(s)	44	770 001	011762	05 00 04 02	753 g/m	1	m	68
767 640	155978	05 00 03 08	2.10 kg	1	pc(s)	163							
767 645	156067	05 00 03 08	2.60 kg	1	pc(s)	44	771 230	144392	05 00 04 14	1.05 kg	1	pc(s)	89
767 645	156067	05 00 03 08	2.60 kg	1	pc(s)	163	771 231	144408	05 00 04 14	1.05 kg	1	pc(s)	89
767 647	156081	05 00 03 08	2.10 kg	1	pc(s)	44	771 232	144415	05 00 04 14	1.05 kg	1	pc(s)	89
767 647	156081	05 00 03 08	2.10 kg	1	pc(s)	163	771 233	144422	05 00 04 14	1.05 kg	1	pc(s)	89
767 666	157071	05 00 03 08	2.20 kg	1	pc(s)	44	771 316	150393	05 00 04 08	418 g	1	pc(s)	72
767 666	157071	05 00 03 08	2.20 kg	1	pc(s)	162							
767 671	156807	05 00 03 08	2.60 kg	1	pc(s)	44	772 310	057593	05 00 04 08	469 g	1	pc(s)	71
767 671	156807	05 00 03 08	2.60 kg	1	pc(s)	163	772 311	057586	05 00 04 08	482 g	1	pc(s)	71
767 701	071292	05 05 01 01	5.70 kg	1	pc(s)	56	772 312	054431	05 00 04 08	480 g	1	pc(s)	76
767 703	070899	05 00 03 01	1.01 kg	1	pc(s)	37	772 313	054448	05 00 04 09	400 g	1	pc(s)	76
767 706	070837	05 00 03 01	1.01 kg	1	pc(s)	37	772 314	080171	05 00 04 08	446 g	1	pc(s)	73
767 710	070851	05 00 03 01	1.01 kg	1	pc(s)	37	772 320	057432	05 00 04 08	785 g	1	pc(s)	71
767 711	070820	05 00 03 01	1.16 kg	1	pc(s)	37	772 321	057449	05 00 04 08	756 g	1	pc(s)	71
767 712	074699	05 50 50 01	37 g	1	pc(s)	99	772 322	054455	05 00 04 09	747 g	1	pc(s)	76
767 713	094925	05 50 50 01	45 g	1	pc(s)	99	772 323	054462	05 00 04 09	876 g	1	pc(s)	76
767 720	070844	05 00 03 01	1.89 kg	1	pc(s)	37	772 324	080188	05 00 04 08	719 g	1	pc(s)	73
767 721	070868	05 00 03 01	1.23 kg	1	pc(s)	37	772 330	069220	05 00 04 08	560 g	1	pc(s)	71
767 724	125902	05 00 03 01	4.22 kg	1	pc(s)	40	772 331	066304	05 00 04 08	566 g	1	pc(s)	71
767 730	070813	05 00 03 01	1.13 kg	1	pc(s)	37	772 340	057456	05 00 04 08	878 g	1	pc(s)	71
767 731	070875	05 00 03 01	1.29 kg	1	pc(s)	37	772 341	057425	05 00 04 08	902 g	1	pc(s)	71
767 733	070882	05 00 03 01	1.29 kg	1	pc(s)	37							
767 740	071063	05 00 03 01	1.45 kg	1	pc(s)	37	773 034	114562	05 00 04 08	634 g	1	pc(s)	71
767 750	071070	05 00 03 01	1.51 kg	1	pc(s)	37	773 130	057722	05 00 04 08	801 g	1	pc(s)	71
767 760	072947	05 00 03 01	177 g	1	pc(s)	99	773 234	114555	05 00 04 08	661 g	1	pc(s)	71
767 761	072954	05 00 03 01	282 g	1	pc(s)	99	773 236	114579	05 00 04 08	714 g	1	pc(s)	74
767 762	072961	05 00 03 01	353 g	1	pc(s)	99	773 251	005990	05 00 04 08	901 g	1	pc(s)	168
767 763	072978	05 00 03 01	529 g	1	pc(s)	99	773 330	057760	05 00 04 08	830 g	1	pc(s)	71
767 764	072114	05 00 03 01	506 g	1	pc(s)	99	773 331	069244	05 00 04 08	793 g	1	pc(s)	74
767 766	091696	05 00 03 01	129 g	1	pc(s)	100							
767 768	113190	05 00 03 01	445 g	1	pc(s)	100	774 034	114586	05 00 04 09	662 g	1	pc(s)	75
767 771	115118	05 00 03 01	600 g	1	pc(s)	100	774 130	057739	05 00 04 09	780 g	1	pc(s)	75
767 776	096486	05 50 50 01	58 g	1	pc(s)	99	774 234	114593	05 00 04 09	772 g	1	pc(s)	76
767 777	096493	05 50 50 01	46 g	1	pc(s)	99	774 251	006003	05 00 04 09	955 g	1	pc(s)	168
767 779	093942	05 00 03 50	3 g	1	pc(s)	99	774 330	057715	05 00 04 09	941 g	1	pc(s)	76
767 903	134737	05 00 03 01	992 g	1	pc(s)	38	774 434	114609	05 00 04 09	712 g	1	pc(s)	76
767 906	134744	05 00 03 01	992 g	1	pc(s)	38	774 530	057746	05 00 04 09	700 g	1	pc(s)	76
767 910	134751	05 00 03 01	992 g	1	pc(s)	38							
767 920	134768	05 00 03 01	1.10 kg	1	pc(s)	38	775 621	102545	05 00 04 09	311 g	1	pc(s)	76
767 921	097360	05 00 03 01	1.65 kg	1	pc(s)	39	775 626	102569	05 00 04 09	343 g	1	pc(s)	76
767 922	097384	05 00 03 01	1.07 kg	1	pc(s)	39	775 631	102552	05 00 04 09	290 g	1	pc(s)	76
767 930	134775	05 00 03 01	1.17 kg	1	pc(s)	38	775 636	102576	05 00 04 09	350 g	1	pc(s)	76
767 931	097377	05 00 03 01	1.08 kg	1	pc(s)	39							
767 932	097391	05 00 03 01	1.07 kg	1	pc(s)	39	782 002	312562	05 20 10 02	5.23 kg	1	pc(s)	149
767 940	134829	05 00 03 01	1.39 kg	1	pc(s)	38	782 020	236509	05 20 10 02	10 g/kit	1	kit	149
767 941	134782	05 00 03 01	1.17 kg	1	pc(s)	38	782 022	236516	05 20 10 02	20 g/kit	1	kit	149
767 944	277731	05 00 03 01	1.38 kg	1	pc(s)	38	782 024	237193	05 20 10 02	36 g/kit	1	kit	149
767 950	134836	05 00 03 01	1.44 kg	1	pc(s)	38	782 028	237223	05 20 10 02	66 g/kit	1	kit	149
767 951	134799	05 00 03 01	1.26 kg	1	pc(s)	38	782 030	245792	05 20 10 02	1.19 kg	1	pc(s)	148
767 960	134812	05 00 03 01	1.32 kg	1	pc(s)	38	782 031	245815	05 20 10 02	1.19 kg	1	pc(s)	148
767 961	134805	05 00 03 01	1.32 kg	1	pc(s)	38	782 040	245822	05 20 10 02	784 g	1	pc(s)	148
767 980	125926	05 00 03 01	5.98 kg	1	pc(s)	40	782 041	245839	05 20 10 02	784 g	1	pc(s)	148
767 996	120181	05 05 01 03	2.30 kg	1	pc(s)	56	782 050	245846	05 20 10 02	851 g	1	pc(s)	148
767 997	115682	05 05 01 02	2.42 kg	1	pc(s)	56	782 051	245853	05 20 10 02	851 g	1	pc(s)	148
767 999	115262	05 05 01 02	3.40 kg	1	pc(s)	56	782 060	245860	05 20 10 02	27 g	1	pc(s)	148
							782 077	273375	05 20 10 02	44 g	1	pc(s)	149
769 300	080867	05 00 04 11	2.80 kg	1	pc(s)	79	782 081	273344	05 20 10 02	49 g	1	pc(s)	149
769 304	149144	05 00 04 11	2.00 kg	1	pc(s)	78	782 085	273443	05 20 10 02	70 g	1	pc(s)	149

Part No.	GTIN*	PG	Weight	PU	SU	Page	Part No.	GTIN*	PG	Weight	PU	SU	Page
782 091	273474	05 20 10 02	77 g	1	pc(s)	149	785 111	070257	05 05 01 04	612 g	1	pc(s)	166
782 092	468092	05 20 10 02	70 g	1	pc(s)	149	785 112	106550	05 01 01 01	17.80 kg	1	pc(s)	106
782 097	445970	05 20 10 02	16 g/kit	5	pc(s)/kit	148	785 119	098213	05 01 01 01	700 g	1	pc(s)	108
782 098	274013	05 20 10 02	31 g/kit	50	pc(s)/kit	149	785 159	284517	05 01 01 01	120 g	1	pc(s)	108
782 099	274006	05 20 10 02	45 g/kit	50	pc(s)/kit	149	785 169	284753	05 01 01 01	312 g	1	pc(s)	108
							785 213	090279	05 01 01 01	320 g	1	pc(s)	108
783 003	310179	05 00 03 03	1.24 kg	1	pc(s)	34	785 214	090286	05 01 01 01	320 g	1	pc(s)	108
783 006	310155	05 00 03 03	1.27 kg	1	pc(s)	34	785 215	090293	05 01 01 01	320 g	1	pc(s)	108
783 010	297869	05 00 03 03	1.23 kg	1	pc(s)	34	785 216	090309	05 01 01 01	320 g	1	pc(s)	108
783 011	310131	05 00 03 03	1.25 kg	1	pc(s)	36	785 217	090316	05 01 01 01	320 g	1	pc(s)	108
783 013	310186	05 00 03 03	1.47 kg	1	pc(s)	34	785 218	090323	05 01 01 01	320 g	1	pc(s)	108
783 020	310124	05 00 03 03	1.35 kg	1	pc(s)	34	785 219	090330	05 01 01 01	320 g	1	pc(s)	108
783 022	310117	05 00 03 03	1.35 kg	1	pc(s)	36	785 225	136434	05 01 01 01	140 g	1	pc(s)	108
783 030	310100	05 00 03 03	1.62 kg	1	pc(s)	34	785 310	092013	05 01 01 01	12.70 kg	1	pc(s)	108
783 033	310162	05 00 03 03	1.28 kg	1	pc(s)	36	785 311	307551	05 00 01 05	110 g	1	pc(s)	25
783 045	310094	05 00 03 03	1.35 kg	1	pc(s)	36	785 312	307568	05 00 01 05	130 g	1	pc(s)	25
783 066	310148	05 00 03 03	1.27 kg	1	pc(s)	36	785 313	307582	05 00 01 05	150 g	1	pc(s)	25
783 103	317277	05 00 03 03	1.27 kg	1	pc(s)	34	785 314	307575	05 00 01 05	250 g	1	pc(s)	25
783 106	317260	05 00 03 03	1.27 kg	1	pc(s)	34	785 315	106277	05 01 01 01	632 g	1	pc(s)	24
783 110	317253	05 00 03 03	1.27 kg	1	pc(s)	34	785 316	106284	05 01 01 01	95 g	1	pc(s)	25
783 120	317246	05 00 03 03	1.35 kg	1	pc(s)	34	785 317	106291	05 01 01 01	130 g	1	pc(s)	25
783 130	317239	05 00 03 03	1.61 kg	1	pc(s)	34	785 318	106307	05 01 01 01	152 g	1	pc(s)	25
783 141	317222	05 00 03 03	1.46 kg	1	pc(s)	35	785 319	106314	05 01 01 01	247 g	1	pc(s)	25
783 151	317215	05 00 03 03	1.55 kg	1	pc(s)	35	785 325	106581	05 01 01 01	600 g	1	pc(s)	24
783 161	317208	05 00 03 03	1.61 kg	1	pc(s)	35	785 329	284760	05 01 01 01	135 g	1	pc(s)	108
783 231	310087	05 00 03 03	1.46 kg	1	pc(s)	34	785 330	451872	05 02 03 01	923 g	1	pc(s)	114
783 233	310063	05 00 03 03	1.46 kg	1	pc(s)	36	785 331	451889	05 02 03 01	916 g	1	pc(s)	114
783 235	310049	05 00 03 03	1.55 kg	1	pc(s)	34	785 332	451896	05 02 03 01	975 g	1	pc(s)	114
783 240	310056	05 00 03 03	1.46 kg	1	pc(s)	34	785 333	451902	05 02 03 01	976 g	1	pc(s)	114
783 243	310018	05 00 03 03	1.55 kg	1	pc(s)	36	785 334	451919	05 02 03 01	1.00 kg	1	pc(s)	114
783 245	310032	05 00 03 03	1.61 kg	1	pc(s)	34	785 335	451926	05 02 03 01	1.05 kg	1	pc(s)	114
783 250	309999	05 00 03 03	1.61 kg	1	pc(s)	34	785 336	451933	05 02 03 01	1.07 kg	1	pc(s)	114
783 255	309982	05 00 03 03	1.61 kg	1	pc(s)	36	785 337	451940	05 02 03 01	1.08 kg	1	pc(s)	114
783 270	309852	05 00 03 03	2.48 kg	1	pc(s)	35	785 338	451957	05 02 03 01	1.21 kg	1	pc(s)	114
783 275	309845	05 00 03 03	2.91 kg	1	pc(s)	35	785 339	462922	05 02 03 11	1.08 kg	1	pc(s)	116
783 280	317284	05 00 03 03	3.31 kg	1	pc(s)	35	785 340	451964	05 02 03 02	831 g	1	pc(s)	114
783 285	316898	05 00 03 03	3.80 kg	1	pc(s)	35	785 341	451988	05 02 03 02	823 g	1	pc(s)	114
783 290	316904	05 00 03 03	5.56 kg	1	pc(s)	35	785 342	451995	05 02 03 02	910 g	1	pc(s)	114
783 332	310070	05 00 03 03	1.46 kg	1	pc(s)	35	785 343	452015	05 02 03 02	912 g	1	pc(s)	114
783 335	310001	05 00 03 03	1.55 kg	1	pc(s)	35	785 344	452022	05 02 03 02	950 g	1	pc(s)	114
783 342	310025	05 00 03 03	1.61 kg	1	pc(s)	35	785 345	452039	05 02 03 02	955 g	1	pc(s)	114
783 345	309975	05 00 03 03	1.61 kg	1	pc(s)	35	785 346	452046	05 02 03 02	978 g	1	pc(s)	114
783 395	309951	05 00 03 03	1.61 kg	1	pc(s)	35	785 347	452053	05 02 03 02	1.02 kg	1	pc(s)	114
783 420	309890	05 00 03 03	1.55 kg	1	pc(s)	157	785 348	452060	05 02 03 02	1.09 kg	1	pc(s)	114
783 430	309906	05 00 03 03	1.55 kg	1	pc(s)	157	785 349	462908	05 02 03 12	1.02 kg	1	pc(s)	116
783 460	309869	05 00 03 03	3.31 kg	1	pc(s)	160	785 350	452077	05 02 03 03	777 g	1	pc(s)	117
783 511	309937	05 00 03 03	1.27 kg	1	pc(s)	36	785 351	452084	05 02 03 03	811 g	1	pc(s)	117
783 520	309913	05 00 03 03	1.55 kg	1	pc(s)	34	785 352	452091	05 02 03 03	830 g	1	pc(s)	117
783 530	309968	05 00 03 03	1.61 kg	1	pc(s)	34	785 353	452107	05 02 03 03	815 g	1	pc(s)	117
783 533	309920	05 00 03 03	1.61 kg	1	pc(s)	36	785 354	452114	05 02 03 03	833 g	1	pc(s)	117
783 536	309944	05 00 03 03	1.61 kg	1	pc(s)	34	785 355	452121	05 02 03 03	880 g	1	pc(s)	117
783 900	292505	05 00 01 01	443 g	1	pc(s)	101	785 356	452138	05 02 03 03	912 g	1	pc(s)	117
783 905	292499	05 00 01 01	488 g	1	pc(s)	101	785 357	452145	05 02 03 03	932 g	1	pc(s)	117
783 906	292482	05 00 01 01	702 g	1	pc(s)	101	785 358	452152	05 02 03 03	936 g	1	pc(s)	117
783 920	292437	05 00 01 50	520 g	1	pc(s)	102	785 359	462939	05 02 03 13	870 g	1	pc(s)	122
783 925	292444	05 00 01 50	745 g	1	pc(s)	102	785 360	452169	05 02 03 04	608 g	1	pc(s)	117
783 930	292451	05 00 03 03	265 g	1	pc(s)	102	785 361	452176	05 02 03 04	648 g	1	pc(s)	117
783 945	436466	05 00 03 03	1.16 kg	1	pc(s)	102	785 362	452183	05 02 03 04	674 g	1	pc(s)	117
							785 363	452190	05 02 03 04	698 g	1	pc(s)	117
784 032	018679	05 00 04 08	969 g	1	pc(s)	73	785 364	452206	05 02 03 04	735 g	1	pc(s)	117
784 038	138452	05 00 04 08	1.01 kg	1	pc(s)	73	785 365	452213	05 02 03 04	763 g	1	pc(s)	117
784 085	018686	05 00 04 08	872 g	1	pc(s)	73	785 366	452220	05 02 03 04	760 g	1	pc(s)	117
784 201	006591	05 00 04 08	880 g	1	pc(s)	73	785 367	452237	05 02 03 04	775 g	1	pc(s)	117
784 301	006553	05 00 04 08	1.70 kg	1	pc(s)	73	785 368	452244	05 02 03 04	866 g	1	pc(s)	117
784 352	006072	05 00 04 08	806 g	1	pc(s)	168	785 369	462915	05 02 03 14	750 g	1	pc(s)	122
784 401	006614	05 00 04 08	1.30 kg	1	pc(s)	73	785 370	456006	05 02 03 50	76 g	1	pc(s)	123
784 480	054479	05 00 04 08	600 g	1	pc(s)	73	785 371	456037	05 02 03 50	80 g	1	pc(s)	123
784 501	006560	05 00 04 08	1.95 kg	1	pc(s)	73	785 372	456051	05 02 03 50	87 g	1	pc(s)	123
784 755	054202	05 00 04 08	1.54 kg	1	pc(s)	168	785 373	456075	05 02 03 50	92 g	1	pc(s)	123
784 756	230118	05 00 04 08	1.60 kg	1	pc(s)	168	785 374	456082	05 02 03 50	95 g	1	pc(s)	123
							785 375	500242	05 02 03 50	102 g	1	pc(s)	123
785 100	087606	05 01 01 01	18.00 kg	1	pc(s)	106	785 376	500259	05 02 03 50	107 g	1	pc(s)	123
785 111	070257	05 05 01 04	612 g	1	pc(s)	92	785 377	501034	05 02 03 50	70 g	1	pc(s)	123
785 111	070257	05 05 01 04	612 g	1	pc(s)	108	785 381	461499	05 01 01 03	196 g	1	Pa	129

Part No.	GTIN*	PG	Weight	PU	SU	Page	Part No.	GTIN*	PG	Weight	PU	SU	Page
785 382	461512	05 01 01 03	215 g	1	Pa	129	785 799	124950	05 02 01 01	337 g	1	Pa	128
785 383	461529	05 01 01 03	243 g	1	Pa	129	785 800	131019	05 02 01 01	340 g	1	Pa	128
785 384	461543	05 01 01 03	244 g	1	Pa	129	785 808	242265	05 02 01 02	250 g	1	Pa	128
785 398	146532	05 01 01 02	156 g	1	pc(s)	109	785 809	242296	05 02 01 02	270 g	1	Pa	128
785 399	146525	05 01 01 02	757 g	1	pc(s)	109	785 810	242302	05 02 01 02	451 g	1	Pa	128
785 442	152847	05 05 01 05	280 g	1	pc(s)	137	785 811	242319	05 02 01 02	452 g	1	Pa	128
785 443	152854	05 05 01 05	550 g	1	pc(s)	137	785 812	242326	05 02 01 02	463 g	1	Pa	128
785 458	115064	05 01 01 05	6 g/mm	1	mm	97	785 820	433182	05 02 05 50	83 g	1	pc(s)	132
785 459	115057	05 01 01 05	56.00 kg	1	pc(s)	97	785 821	426979	05 02 05 04	325 g	1	pc(s)	132
785 465	088733	05 01 01 05	41.50 kg	1	pc(s)	97	785 822	426993	05 02 05 04	327 g	1	pc(s)	132
785 466	088030	05 01 01 05	0.83 g/mm	1	mm	97	785 823	427013	05 02 05 04	329 g	1	pc(s)	132
785 467	088740	05 01 01 05	38.00 kg	1	pc(s)	97	785 824	426986	05 02 05 04	350 g	1	pc(s)	132
785 468	088757	05 01 01 05	1.64 g/mm	1	mm	97	785 825	427006	05 02 05 04	348 g	1	pc(s)	132
785 471	088764	05 01 01 05	20.00 kg	1	pc(s)	98	785 826	427020	05 02 05 04	352 g	1	pc(s)	132
785 472	087057	05 01 01 05	1.95 g/mm	1	mm	98	785 827	433199	05 02 05 50	103 g	1	pc(s)	132
785 490	086890	05 01 01 03	240 g	1	pc(s)	129	785 828	459953	05 02 05 50	23 g	1	kit	132
785 490	086890	05 01 01 03	240 g	1	pc(s)	130	785 829	459113	05 02 05 50	41 g	1	pc(s)	132
785 502	087347	05 01 01 01	7.20 kg	1	pc(s)	105	785 830	486157	05 02 01 07	207 g	1	Pa	127
785 592	087552	05 01 01 01	50 g	1	pc(s)	108	785 831	486164	05 02 01 07	210 g	1	Pa	127
785 637	100701	05 00 02 01	14 g	10	pc(s)	29	785 832	486171	05 02 01 07	244 g	1	Pa	127
785 638	086920	05 00 02 01	6 g	10	pc(s)	29	785 833	486188	05 02 01 07	266 g	1	Pa	127
785 639	087019	05 00 02 01	15 g	10	pc(s)	28	785 834	486195	05 02 01 07	272 g	1	Pa	127
785 640	087026	05 00 02 01	55 g	10	pc(s)	28	785 835	486201	05 02 01 07	290 g	1	Pa	127
785 641	087897	05 00 02 01	55 g	10	pc(s)	28	785 836	486218	05 02 01 07	305 g	1	Pa	127
785 642	087903	05 00 02 01	75 g	10	pc(s)	28	785 840	486232	05 02 01 08	300 g	1	Pa	127
785 643	087910	05 00 02 01	80 g	10	pc(s)	28	785 841	486249	05 02 01 08	305 g	1	Pa	127
785 644	087927	05 00 02 01	80 g	10	pc(s)	28	785 842	486256	05 02 01 08	326 g	1	Pa	127
785 645	086869	05 01 01 03	420 g	1	pc(s)	128	785 843	486263	05 02 01 08	369 g	1	Pa	127
785 646	089174	05 01 01 05	760 g	1	pc(s)	97	785 844	486270	05 02 01 08	369 g	1	Pa	127
785 647	087040	05 01 01 05	73 g	1	pc(s)	98	785 845	486287	05 02 01 08	392 g	1	Pa	127
785 648	088047	05 01 01 05	19 g	1	pc(s)	98	785 846	486294	05 02 01 08	405 g	1	Pa	127
785 649	088054	05 01 01 05	2 g	1	pc(s)	98	785 850	486300	05 02 01 05	297 g	1	Pa	127
785 650	106536	05 00 02 01	22 g	10	pc(s)	28	785 851	486317	05 02 01 05	310 g	1	Pa	127
785 652	111479	05 00 02 01	8 g	10	pc(s)	29	785 852	486324	05 02 01 05	320 g	1	Pa	127
785 705	341449	05 02 04 01	400 g	1	pc(s)	135	785 853	486331	05 02 01 05	330 g	1	Pa	127
785 706	341456	05 02 04 01	400 g	1	pc(s)	135	785 854	486348	05 02 01 05	343 g	1	Pa	127
785 707	341487	05 02 04 01	400 g	1	pc(s)	135	785 855	486355	05 02 01 05	363 g	1	Pa	127
785 708	341463	05 02 04 01	400 g	1	pc(s)	135	785 856	486362	05 02 01 05	367 g	1	Pa	127
785 709	341470	05 02 04 01	400 g	1	pc(s)	135	785 860	486379	05 02 01 06	380 g	1	Pa	127
785 721	360198	05 02 05 03	182 g	1	pc(s)	134	785 861	486386	05 02 01 06	383 g	1	Pa	127
785 722	360242	05 02 05 03	294 g	1	pc(s)	134	785 862	486393	05 02 01 06	390 g	1	Pa	127
785 723	360266	05 02 04 50	148 g	1	pc(s)	135	785 863	486430	05 02 01 06	390 g	1	Pa	127
785 724	360310	05 02 05 50	52 g	1	pc(s)	132	785 864	486409	05 02 01 06	420 g	1	Pa	127
785 724	360310	05 02 05 50	52 g	1	pc(s)	133	785 865	486416	05 02 01 06	427 g	1	Pa	127
785 724	360310	05 02 05 50	52 g	1	pc(s)	134	785 866	486423	05 02 01 06	447 g	1	Pa	127
785 724	360310	05 02 05 50	52 g	1	pc(s)	137	785 870	497504	05 02 05 05	410 g	1	pc(s)	133
785 738	274716	05 02 04 50	39 g	1	pc(s)	135	785 900	469556	05 02 03 50	2.43 kg	1	pc(s)	136
785 739	274723	05 02 04 50	5 g	10	pc(s)	135	785 901	469563	05 02 03 50	2.43 kg	1	pc(s)	136
785 755	152861	05 02 02 03	2.62 kg	1	pc(s)	125	785 902	469570	05 02 03 50	2.55 kg	1	pc(s)	136
785 756	152878	05 02 02 03	2.73 kg	1	pc(s)	125	785 903	469587	05 02 03 50	3.08 kg	1	pc(s)	136
785 757	152885	05 02 02 03	2.83 kg	1	pc(s)	125	785 904	469594	05 02 03 50	3.18 kg	1	pc(s)	136
785 758	245150	05 02 02 03	3.21 kg	1	pc(s)	125	785 905	469600	05 02 03 50	3.27 kg	1	pc(s)	136
785 759	329362	05 02 02 03	3.28 kg	1	pc(s)	125	785 906	476516	05 02 03 50	2.43 kg	1	pc(s)	136
785 760	336384	05 02 02 04	800 g	1	pc(s)	134	785 907	476523	05 02 03 50	2.55 kg	1	pc(s)	136
785 769	152007	05 02 02 01	1.86 kg	1	pc(s)	126	785 908	476530	05 02 03 50	3.08 kg	1	pc(s)	136
785 770	149458	05 02 02 01	1.86 kg	1	pc(s)	126	785 909	476547	05 02 03 50	3.27 kg	1	pc(s)	136
785 771	149465	05 02 02 01	1.73 kg	1	pc(s)	126	785 940	106253	05 01 01 01	10.85 kg	1	pc(s)	105
785 772	149472	05 02 02 01	1.85 kg	1	pc(s)	126	785 950	106383	05 01 01 01	27.30 kg	1	pc(s)	107
785 773	149489	05 02 02 01	1.90 kg	1	pc(s)	126	785 960	502796	05 99 00 00	-	1	pc(s)	136
785 774	149502	05 02 02 01	2.16 kg	1	pc(s)	126	785 961	502789	05 99 00 00	-	1	pc(s)	137
785 775	149519	05 02 02 01	2.01 kg	1	pc(s)	126							
785 779	151994	05 02 02 02	1.40 kg	1	pc(s)	126	786 711	438958	05 08 01 03	1.30 kg	1	pc(s)	142
785 780	149526	05 02 02 02	1.46 kg	1	pc(s)	126	786 712	439047	05 08 01 03	1.37 kg	1	pc(s)	142
785 781	149533	05 02 02 02	1.53 kg	1	pc(s)	126	786 713	439054	05 08 01 03	1.43 kg	1	pc(s)	142
785 782	149540	05 02 02 02	1.53 kg	1	pc(s)	126	786 714	439061	05 08 01 03	1.50 kg	1	pc(s)	142
785 783	149557	05 02 02 02	1.65 kg	1	pc(s)	126	786 715	439078	05 08 01 03	1.59 kg	1	pc(s)	142
785 784	149564	05 02 02 02	1.73 kg	1	pc(s)	126	786 716	439085	05 08 01 03	1.67 kg	1	pc(s)	142
785 785	149571	05 02 02 02	1.83 kg	1	pc(s)	126	786 717	438965	05 08 01 02	298 g	1	Pa	141
785 788	149588	05 02 02 02	112 g	1	pc(s)	126	786 718	439108	05 08 01 02	323 g	1	Pa	141
785 789	149595	05 02 02 02	75 g	1	Pa	126	786 719	439115	05 08 01 02	329 g	1	Pa	141
785 790	489776	05 02 05 50	167 g	1	mm	133	786 720	439122	05 08 01 02	336 g	1	Pa	141
785 796	124912	05 02 01 01	310 g	1	Pa	128	786 721	439139	05 08 01 02	352 g	1	Pa	141
785 797	124936	05 02 01 01	330 g	1	Pa	128	786 722	439146	05 08 01 04	111 g	1	Pa	141
785 798	124943	05 02 01 01	317 g	1	Pa	128	786 723	439153	05 08 01 04	115 g	1	Pa	141

Part No.	GTIN*	PG	Weight	PU	SU	Page	Part No.	GTIN*	PG	Weight	PU	SU	Page
786 724	439160	05 08 01 04	119 g	1	Pa	141	787 204	507951	05 01 01 03	600 g	1	Pa	131
786 725	439177	05 08 01 04	121 g	1	Pa	141	787 205	507968	05 01 01 03	600 g	1	Pa	131
786 726	430631	05 08 01 50	816 g	1	pc(s)	142	787 206	507975	05 01 01 03	600 g	1	Pa	131
786 741	365438	05 08 01 01	2.16 kg	1	pc(s)	140	787 207	507982	05 01 01 03	600 g	1	Pa	131
786 742	365445	05 08 01 01	2.19 kg	1	pc(s)	140	787 208	507999	05 01 01 03	600 g	1	Pa	131
786 743	365452	05 08 01 01	2.45 kg	1	pc(s)	140	787 209	508002	05 01 01 03	600 g	1	Pa	131
786 744	365469	05 08 01 01	2.53 kg	1	pc(s)	140	787 210	508019	05 01 01 03	600 g	1	Pa	131
786 745	365476	05 08 01 01	2.66 kg	1	pc(s)	140	787 211	508026	05 01 01 03	600 g	1	Pa	131
786 746	365483	05 08 01 01	2.76 kg	1	pc(s)	140	787 220	508033	05 01 01 03	650 g	1	Pa	131
786 751	365247	05 08 01 01	1.64 kg	1	pc(s)	140	787 221	508040	05 01 01 03	650 g	1	Pa	131
786 752	365254	05 08 01 01	1.68 kg	1	pc(s)	140	787 222	508057	05 01 01 03	650 g	1	Pa	131
786 753	365261	05 08 01 01	1.78 kg	1	pc(s)	140	787 223	508064	05 01 01 03	650 g	1	Pa	131
786 754	365278	05 08 01 01	1.86 kg	1	pc(s)	140	787 224	508088	05 01 01 03	650 g	1	Pa	131
786 755	365285	05 08 01 01	1.94 kg	1	pc(s)	140	787 225	508095	05 01 01 03	650 g	1	Pa	131
786 756	365292	05 08 01 01	2.03 kg	1	pc(s)	140	787 226	508101	05 01 01 03	650 g	1	Pa	131
786 761	365308	05 08 01 01	207 g	1	Pa	140	787 227	508118	05 01 01 03	650 g	1	Pa	131
786 762	365315	05 08 01 01	226 g	1	Pa	140	787 228	508125	05 01 01 03	650 g	1	Pa	131
786 763	365322	05 08 01 01	245 g	1	Pa	140	787 229	508132	05 01 01 03	650 g	1	Pa	131
786 764	365339	05 08 01 01	251 g	1	Pa	140	787 230	508149	05 01 01 03	650 g	1	Pa	131
786 765	365346	05 08 01 01	276 g	1	Pa	140	787 231	508156	05 01 01 03	650 g	1	Pa	131
786 766	365360	05 08 01 01	300 g	1	Pa	140	787 350	478169	05 02 03 03	777 g	1	pc(s)	120
786 770	365353	05 08 01 01	825 g	1	pc(s)	140	787 351	478176	05 02 03 03	811 g	1	pc(s)	120
786 781	365377	05 08 01 01	372 g	1	Pa	140	787 352	478183	05 02 03 03	830 g	1	pc(s)	120
786 782	365384	05 08 01 01	393 g	1	Pa	140	787 353	478190	05 02 03 03	815 g	1	pc(s)	120
786 783	365391	05 08 01 01	413 g	1	Pa	140	787 354	478206	05 02 03 03	833 g	1	pc(s)	120
786 784	365407	05 08 01 01	420 g	1	Pa	140	787 355	478213	05 02 03 03	880 g	1	pc(s)	120
786 785	365414	05 08 01 01	428 g	1	Pa	140	787 356	478220	05 02 03 03	912 g	1	pc(s)	120
786 786	365421	05 08 01 01	436 g	1	Pa	140	787 357	478237	05 02 03 03	932 g	1	pc(s)	120
							787 358	478244	05 02 03 03	936 g	1	pc(s)	120
787 000	483088	05 01 01 03	500 g	1	pc(s)	129	787 360	478251	05 02 03 04	608 g	1	pc(s)	120
787 000	483088	05 01 01 03	500 g	1	pc(s)	130	787 361	478268	05 02 03 04	648 g	1	pc(s)	120
787 001	482296	05 02 03 15	453 g	1	pc(s)	123	787 362	478275	05 02 03 04	674 g	1	pc(s)	120
787 002	482302	05 02 03 15	477 g	1	pc(s)	123	787 363	478282	05 02 03 04	698 g	1	pc(s)	120
787 003	482319	05 02 03 15	497 g	1	pc(s)	123	787 364	478299	05 02 03 04	735 g	1	pc(s)	120
787 004	482425	05 02 03 15	487 g	1	pc(s)	123	787 365	478305	05 02 03 04	763 g	1	pc(s)	120
787 005	482654	05 02 03 15	517 g	1	pc(s)	123	787 366	478312	05 02 03 04	760 g	1	pc(s)	120
787 006	482661	05 02 03 15	530 g	1	pc(s)	123	787 367	478329	05 02 03 04	775 g	1	pc(s)	120
787 007	482722	05 02 03 15	547 g	1	pc(s)	123	787 368	478336	05 02 03 04	866 g	1	pc(s)	120
787 008	482715	05 02 03 15	570 g	1	pc(s)	123	787 370	512467	05 02 03 03	---	1	pc(s)	124
787 011	482739	05 02 03 15	277 g	1	pc(s)	124	787 371	512337	05 02 03 03	---	1	pc(s)	124
787 012	482746	05 02 03 15	293 g	1	pc(s)	124	787 372	512344	05 02 03 03	---	1	pc(s)	124
787 013	482753	05 02 03 15	307 g	1	pc(s)	124	787 373	512351	05 02 03 03	---	1	pc(s)	124
787 014	482760	05 02 03 15	323 g	1	pc(s)	124	787 374	512368	05 02 03 03	---	1	pc(s)	124
787 015	482777	05 02 03 15	353 g	1	pc(s)	124	787 375	512375	05 02 03 03	---	1	pc(s)	124
787 016	482784	05 02 03 15	367 g	1	pc(s)	124	787 376	512382	05 02 03 03	---	1	pc(s)	124
787 017	482791	05 02 03 15	390 g	1	pc(s)	124	787 380	512399	05 02 03 04	---	1	pc(s)	125
787 018	482807	05 02 03 15	407 g	1	pc(s)	124	787 381	512405	05 02 03 04	---	1	pc(s)	125
787 021	482814	05 02 03 15	237 g	1	pc(s)	124	787 382	512412	05 02 03 04	---	1	pc(s)	125
787 022	482821	05 02 03 15	227 g	1	pc(s)	124	787 383	512429	05 02 03 04	---	1	pc(s)	125
787 023	482432	05 02 03 15	250 g	1	pc(s)	124	787 384	512436	05 02 03 04	---	1	pc(s)	125
787 024	482449	05 02 03 15	247 g	1	pc(s)	124	787 385	512443	05 02 03 04	---	1	pc(s)	125
787 025	482456	05 02 03 15	260 g	1	pc(s)	124	787 386	512450	05 02 03 04	---	1	pc(s)	125
787 026	482463	05 02 03 15	277 g	1	pc(s)	124	787 457	480070	05 01 01 05	33.10 kg	1	pc(s)	96
787 027	482470	05 02 03 15	287 g	1	pc(s)	124	787 459	480087	05 01 01 05	83.20 kg	1	pc(s)	96
787 028	482487	05 02 03 15	293 g	1	pc(s)	124	787 461	513884	05 01 01 05	---	1	pc(s)	96
787 100	483118	05 01 01 03	430 g	1	Pa	130	787 462	513839	05 01 01 05	---	1	pc(s)	96
787 101	483125	05 01 01 03	430 g	1	Pa	130	787 463	513891	05 01 01 05	---	1	pc(s)	96
787 102	483132	05 01 01 03	430 g	1	Pa	130	787 464	513907	05 01 01 05	---	1	pc(s)	96
787 103	483149	05 01 01 03	650 g	1	Pa	130	787 465	513914	05 01 01 05	---	1	pc(s)	96
787 104	483156	05 01 01 03	650 g	1	Pa	130	787 466	513846	05 01 01 05	---	1	pc(s)	96
787 105	483163	05 01 01 03	650 g	1	Pa	130	787 467	513853	05 01 01 05	---	1	pc(s)	96
787 106	483170	05 01 01 03	650 g	1	Pa	130	787 468	513860	05 01 01 05	---	1	pc(s)	96
787 107	483187	05 01 01 03	830 g	1	Pa	130	787 469	513938	05 01 01 05	---	1	pc(s)	96
787 108	483194	05 01 01 03	830 g	1	Pa	130	787 471	513747	05 01 01 05	---	1	pc(s)	96
787 109	483224	05 01 01 03	830 g	1	Pa	130	787 472	513754	05 01 01 05	---	1	pc(s)	96
787 110	483231	05 01 01 03	830 g	1	Pa	130	787 473	513761	05 01 01 05	---	1	pc(s)	96
787 111	483248	05 01 01 03	960 g	1	Pa	130	787 474	513778	05 01 01 05	---	1	pc(s)	96
787 112	483255	05 01 01 03	960 g	1	Pa	130	787 475	513785	05 01 01 05	---	1	pc(s)	96
787 113	483262	05 01 01 03	960 g	1	Pa	130	787 476	513792	05 01 01 05	---	1	pc(s)	96
787 114	483279	05 01 01 03	960 g	1	Pa	130	787 477	513808	05 01 01 05	---	1	pc(s)	96
787 200	507876	05 01 01 03	600 g	1	Pa	131	787 478	513815	05 01 01 05	---	1	pc(s)	96
787 201	507920	05 01 01 03	600 g	1	Pa	131	787 479	513822	05 01 01 05	---	1	pc(s)	96
787 202	507937	05 01 01 03	600 g	1	Pa	131	787 480	479821	05 01 01 03	95 g	1	Pa	129
787 203	507944	05 01 01 03	600 g	1	Pa	131	787 481	479838	05 01 01 03	115 g	1	Pa	129

Part No.	GTIN*	PG	Weight	PU	SU	Page	Part No.	GTIN*	PG	Weight	PU	SU	Page
787 482	479845	05 01 01 03	123 g	1	Pa	129	787 670	490604	05 02 03 02	1.08 kg	1	pc(s)	115
787 483	479852	05 01 01 03	146 g	1	Pa	129	787 671	490611	05 02 03 02	1.08 kg	1	pc(s)	115
787 484	479814	05 01 01 03	183 g	1	Pa	129	787 672	490628	05 02 03 02	1.08 kg	1	pc(s)	115
787 485	479920	05 01 01 03	197 g	1	Pa	129	787 673	490635	05 02 03 02	1.08 kg	1	pc(s)	115
787 486	479937	05 01 01 03	200 g	1	Pa	129	787 674	490642	05 02 03 02	1.08 kg	1	pc(s)	115
787 487	479944	05 01 01 03	226 g	1	Pa	129	787 675	490659	05 02 03 02	1.08 kg	1	pc(s)	115
787 490	479951	05 01 01 03	303 g	1	Pa	129	787 676	490666	05 02 03 02	1.08 kg	1	pc(s)	115
787 491	479968	05 01 01 03	347 g	1	Pa	129	787 677	490673	05 02 03 02	1.08 kg	1	pc(s)	115
787 492	479975	05 01 01 03	363 g	1	Pa	129	787 680	490680	05 02 03 02	878 g	1	pc(s)	116
787 493	479982	05 01 01 03	353 g	1	Pa	129	787 681	490697	05 02 03 02	878 g	1	pc(s)	116
787 494	479999	05 01 01 03	427 g	1	Pa	129	787 682	490703	05 02 03 02	878 g	1	pc(s)	116
787 495	480001	05 01 01 03	433 g	1	Pa	129	787 683	490710	05 02 03 02	878 g	1	pc(s)	116
787 496	480018	05 01 01 03	483 g	1	Pa	129	787 684	490727	05 02 03 02	878 g	1	pc(s)	116
787 497	480025	05 01 01 03	487 g	1	Pa	129	787 685	490734	05 02 03 02	878 g	1	pc(s)	116
787 600	490130	05 02 03 01	2.00 kg	1	pc(s)	114	787 686	490741	05 02 03 02	878 g	1	pc(s)	116
787 601	490147	05 02 03 01	2.00 kg	1	pc(s)	114	787 687	490758	05 02 03 02	878 g	1	pc(s)	116
787 602	490154	05 02 03 01	2.00 kg	1	pc(s)	114	787 688	490765	05 02 03 02	878 g	1	pc(s)	116
787 603	490161	05 02 03 01	2.00 kg	1	pc(s)	114	787 689	490772	05 02 03 02	878 g	1	pc(s)	116
787 604	492165	05 02 03 01	2.00 kg	1	pc(s)	114	787 690	490789	05 02 03 02	878 g	1	pc(s)	116
787 610	490178	05 02 03 01	960 g	1	pc(s)	115	787 691	496194	05 02 03 02	878 g	1	pc(s)	116
787 611	490185	05 02 03 01	960 g	1	pc(s)	115	787 700	490796	05 02 03 03	2.00 kg	1	pc(s)	117
787 612	490192	05 02 03 01	960 g	1	pc(s)	115	787 701	490802	05 02 03 03	2.00 kg	1	pc(s)	117
787 613	490208	05 02 03 01	960 g	1	pc(s)	115	787 702	490819	05 02 03 03	2.00 kg	1	pc(s)	117
787 614	490215	05 02 03 01	960 g	1	pc(s)	115	787 703	490826	05 02 03 03	2.00 kg	1	pc(s)	117
787 615	490222	05 02 03 01	960 g	1	pc(s)	115	787 704	490833	05 02 03 03	2.00 kg	1	pc(s)	117
787 616	490239	05 02 03 01	960 g	1	pc(s)	115	787 710	490840	05 02 03 03	980 g	1	pc(s)	118
787 617	490246	05 02 03 01	960 g	1	pc(s)	115	787 711	490857	05 02 03 03	980 g	1	pc(s)	118
787 618	490253	05 02 03 01	960 g	1	pc(s)	115	787 712	490864	05 02 03 03	980 g	1	pc(s)	118
787 620	490260	05 02 03 01	1.11 kg	1	pc(s)	115	787 713	490871	05 02 03 03	980 g	1	pc(s)	118
787 621	490277	05 02 03 01	1.11 kg	1	pc(s)	115	787 714	490888	05 02 03 03	980 g	1	pc(s)	118
787 622	490284	05 02 03 01	1.11 kg	1	pc(s)	115	787 715	490895	05 02 03 03	980 g	1	pc(s)	118
787 623	490291	05 02 03 01	1.11 kg	1	pc(s)	115	787 716	490901	05 02 03 03	980 g	1	pc(s)	118
787 624	490307	05 02 03 01	1.11 kg	1	pc(s)	115	787 717	490918	05 02 03 03	980 g	1	pc(s)	118
787 625	490314	05 02 03 01	1.11 kg	1	pc(s)	115	787 718	490925	05 02 03 03	980 g	1	pc(s)	118
787 626	490321	05 02 03 01	1.11 kg	1	pc(s)	115	787 720	490932	05 02 03 03	1.02 kg	1	pc(s)	118
787 627	490338	05 02 03 01	1.11 kg	1	pc(s)	115	787 721	490949	05 02 03 03	1.02 kg	1	pc(s)	118
787 630	490345	05 02 03 01	960 g	1	pc(s)	116	787 722	490956	05 02 03 03	1.02 kg	1	pc(s)	118
787 631	490352	05 02 03 01	960 g	1	pc(s)	116	787 723	490963	05 02 03 03	1.02 kg	1	pc(s)	118
787 632	490369	05 02 03 01	960 g	1	pc(s)	116	787 724	490970	05 02 03 03	1.02 kg	1	pc(s)	118
787 633	490376	05 02 03 01	960 g	1	pc(s)	116	787 725	490987	05 02 03 03	1.02 kg	1	pc(s)	118
787 634	490383	05 02 03 01	960 g	1	pc(s)	116	787 726	490994	05 02 03 03	1.02 kg	1	pc(s)	118
787 635	490390	05 02 03 01	960 g	1	pc(s)	116	787 727	491007	05 02 03 03	1.02 kg	1	pc(s)	118
787 636	490406	05 02 03 01	960 g	1	pc(s)	116	787 730	491014	05 02 03 03	880 g	1	pc(s)	119
787 637	490413	05 02 03 01	960 g	1	pc(s)	116	787 731	491021	05 02 03 03	880 g	1	pc(s)	119
787 638	490420	05 02 03 01	960 g	1	pc(s)	116	787 732	491038	05 02 03 03	880 g	1	pc(s)	119
787 639	490437	05 02 03 01	960 g	1	pc(s)	116	787 733	491045	05 02 03 03	880 g	1	pc(s)	119
787 640	490444	05 02 03 01	960 g	1	pc(s)	116	787 734	491052	05 02 03 03	880 g	1	pc(s)	119
787 641	490451	05 02 03 01	960 g	1	pc(s)	116	787 735	491069	05 02 03 03	880 g	1	pc(s)	119
787 650	490468	05 02 03 02	2.00 kg	1	pc(s)	114	787 736	491076	05 02 03 03	880 g	1	pc(s)	119
787 651	490475	05 02 03 02	2.00 kg	1	pc(s)	114	787 737	491083	05 02 03 03	880 g	1	pc(s)	119
787 652	490482	05 02 03 02	2.00 kg	1	pc(s)	114	787 738	491090	05 02 03 03	880 g	1	pc(s)	119
787 653	490499	05 02 03 02	2.00 kg	1	pc(s)	114	787 739	491106	05 02 03 03	880 g	1	pc(s)	119
787 654	490505	05 02 03 02	2.00 kg	1	pc(s)	114	787 740	491113	05 02 03 03	880 g	1	pc(s)	119
787 660	490512	05 02 03 02	1.02 kg	1	pc(s)	115	787 741	491120	05 02 03 03	880 g	1	pc(s)	119
787 661	490529	05 02 03 02	1.02 kg	1	pc(s)	115	787 750	491137	05 02 03 04	2.00 kg	1	pc(s)	117
787 662	490536	05 02 03 02	1.02 kg	1	pc(s)	115	787 751	491144	05 02 03 04	2.00 kg	1	pc(s)	117
787 663	490543	05 02 03 02	1.02 kg	1	pc(s)	115	787 752	491151	05 02 03 04	2.00 kg	1	pc(s)	117
787 664	490550	05 02 03 02	1.02 kg	1	pc(s)	115	787 753	491168	05 02 03 04	2.00 kg	1	pc(s)	117
787 665	490567	05 02 03 02	1.02 kg	1	pc(s)	115	787 754	491175	05 02 03 04	2.00 kg	1	pc(s)	117
787 666	490574	05 02 03 02	1.02 kg	1	pc(s)	115	787 760	491182	05 02 03 04	770 g	1	pc(s)	118
787 667	490581	05 02 03 02	1.02 kg	1	pc(s)	115	787 761	491199	05 02 03 04	770 g	1	pc(s)	118
787 668	490598	05 02 03 02	1.02 kg	1	pc(s)	115	787 762	491205	05 02 03 04	770 g	1	pc(s)	118

Part No.	GTIN*	PG	Weight	PU	SU	Page	Part No.	GTIN*	PG	Weight	PU	SU	Page
787 763	491212	05 02 03 04	770 g	1	pc(s)	118	787 852	491847	05 02 03 04	2.00 kg	1	pc(s)	120
787 764	491229	05 02 03 04	770 g	1	pc(s)	118	787 853	491854	05 02 03 04	2.00 kg	1	pc(s)	120
787 765	491236	05 02 03 04	770 g	1	pc(s)	118	787 854	491861	05 02 03 04	2.00 kg	1	pc(s)	120
787 766	491243	05 02 03 04	770 g	1	pc(s)	118	787 860	491878	05 02 03 04	850 g	1	pc(s)	121
787 767	491250	05 02 03 04	770 g	1	pc(s)	118	787 861	491885	05 02 03 04	850 g	1	pc(s)	121
787 768	491267	05 02 03 04	770 g	1	pc(s)	118	787 862	491892	05 02 03 04	850 g	1	pc(s)	121
787 770	491274	05 02 03 04	840 g	1	pc(s)	118	787 863	491908	05 02 03 04	850 g	1	pc(s)	121
787 771	491281	05 02 03 04	840 g	1	pc(s)	118	787 864	491915	05 02 03 04	850 g	1	pc(s)	121
787 772	491298	05 02 03 04	840 g	1	pc(s)	118	787 865	491922	05 02 03 04	850 g	1	pc(s)	121
787 773	491304	05 02 03 04	840 g	1	pc(s)	118	787 866	491939	05 02 03 04	850 g	1	pc(s)	121
787 774	491311	05 02 03 04	840 g	1	pc(s)	118	787 867	491946	05 02 03 04	850 g	1	pc(s)	121
787 775	491328	05 02 03 04	840 g	1	pc(s)	118	787 868	491953	05 02 03 04	850 g	1	pc(s)	121
787 776	491335	05 02 03 04	840 g	1	pc(s)	118	787 870	491960	05 02 03 04	930 g	1	pc(s)	121
787 777	491342	05 02 03 04	840 g	1	pc(s)	118	787 871	491977	05 02 03 04	930 g	1	pc(s)	121
787 780	491359	05 02 03 04	930 g	1	pc(s)	119	787 872	491984	05 02 03 04	930 g	1	pc(s)	121
787 781	491366	05 02 03 04	930 g	1	pc(s)	119	787 873	491991	05 02 03 04	930 g	1	pc(s)	121
787 782	491373	05 02 03 04	930 g	1	pc(s)	119	787 874	492004	05 02 03 04	930 g	1	pc(s)	121
787 783	491380	05 02 03 04	930 g	1	pc(s)	119	787 875	492011	05 02 03 04	930 g	1	pc(s)	121
787 784	491397	05 02 03 04	930 g	1	pc(s)	119	787 876	492028	05 02 03 04	930 g	1	pc(s)	121
787 785	491403	05 02 03 04	930 g	1	pc(s)	119	787 877	492035	05 02 03 04	930 g	1	pc(s)	121
787 786	491410	05 02 03 04	930 g	1	pc(s)	119	787 880	492042	05 02 03 04	748 g	1	pc(s)	122
787 787	491427	05 02 03 04	930 g	1	pc(s)	119	787 881	492059	05 02 03 04	748 g	1	pc(s)	122
787 788	491434	05 02 03 04	930 g	1	pc(s)	119	787 882	492066	05 02 03 04	748 g	1	pc(s)	122
787 789	491441	05 02 03 04	930 g	1	pc(s)	119	787 883	492073	05 02 03 04	748 g	1	pc(s)	122
787 790	491458	05 02 03 04	678 g	1	pc(s)	119	787 884	492080	05 02 03 04	748 g	1	pc(s)	122
787 791	491465	05 02 03 04	678 g	1	pc(s)	119	787 885	492097	05 02 03 04	748 g	1	pc(s)	122
787 800	491472	05 02 03 03	2.00 kg	1	pc(s)	120	787 886	492103	05 02 03 04	748 g	1	pc(s)	122
787 801	491489	05 02 03 03	2.00 kg	1	pc(s)	120	787 887	492110	05 02 03 04	748 g	1	pc(s)	122
787 802	491496	05 02 03 03	2.00 kg	1	pc(s)	120	787 888	492127	05 02 03 04	748 g	1	pc(s)	122
787 803	491502	05 02 03 03	2.00 kg	1	pc(s)	120	787 889	492134	05 02 03 04	748 g	1	pc(s)	122
787 804	491519	05 02 03 03	2.00 kg	1	pc(s)	120	787 890	492141	05 02 03 04	748 g	1	pc(s)	122
787 810	491526	05 02 03 03	950 g	1	pc(s)	121	787 891	492158	05 02 03 04	748 g	1	pc(s)	122
787 811	491533	05 02 03 03	950 g	1	pc(s)	121	790 150	005365	05 00 04 09	450 g	1	pc(s)	76
787 812	491540	05 02 03 03	950 g	1	pc(s)	121	790 160	018693	05 00 04 09	737 g	1	pc(s)	76
787 813	491557	05 02 03 03	950 g	1	pc(s)	121	790 250	089495	05 00 04 01	193 g	1	pc(s)	65
787 814	491564	05 02 03 03	950 g	1	pc(s)	121	790 251	089501	05 00 04 01	248 g	1	pc(s)	65
787 815	491571	05 02 03 03	950 g	1	pc(s)	121	790 260	089518	05 00 04 01	180 g	1	pc(s)	65
787 816	491588	05 02 03 03	950 g	1	pc(s)	121	790 261	089525	05 00 04 01	277 g	1	pc(s)	65
787 817	491595	05 02 03 03	950 g	1	pc(s)	121	792 030	005853	05 00 04 09	610 g	1	pc(s)	77
787 818	491601	05 02 03 03	950 g	1	pc(s)	121	792 190	068315	05 00 04 09	1.22 kg	1	pc(s)	76
787 820	491618	05 02 03 03	1.06 kg	1	pc(s)	121	792 450	051744	05 00 04 09	2.60 kg	1	pc(s)	168
787 821	491625	05 02 03 03	1.06 kg	1	pc(s)	121	792 451	230170	05 00 04 09	2.60 kg	1	pc(s)	168
787 822	491632	05 02 03 03	1.06 kg	1	pc(s)	121	792 455	376724	05 00 04 09	2.89 kg	1	pc(s)	168
787 823	491649	05 02 03 03	1.06 kg	1	pc(s)	121	792 456	446625	05 00 04 09	2.94 kg	1	pc(s)	168
787 824	491656	05 02 03 03	1.06 kg	1	pc(s)	121	795 001	011816	05 00 04 02	1.00 kg/m	1	m	68
787 825	491663	05 02 03 03	1.06 kg	1	pc(s)	121	795 020	424296	05 00 04 10	2.87 kg	1	pc(s)	83
787 826	491670	05 02 03 03	1.06 kg	1	pc(s)	121	795 212	423237	05 00 04 10	331 g	1	pc(s)	83
787 827	491687	05 02 03 03	1.06 kg	1	pc(s)	121	799 006	157347	05 00 04 09	4.00 kg	1	pc(s)	75
787 830	491694	05 02 03 03	880 g	1	pc(s)	122	799 009	123298	05 00 04 09	5.10 kg	1	pc(s)	74
787 831	491700	05 02 03 03	880 g	1	pc(s)	122	799 019	123304	05 00 04 09	328 g	1	pc(s)	74
787 832	491724	05 02 03 03	880 g	1	pc(s)	122	799 100	237094	05 04 01 01	12.20 kg	1	pc(s)	92
787 833	491731	05 02 03 03	880 g	1	pc(s)	122	923 110	092426	05 03 01 01	46 g	10	pc(s)	172
787 834	491748	05 02 03 03	880 g	1	pc(s)	122	923 116	085978	05 03 01 01	42 g	10	pc(s)	172
787 835	491755	05 02 03 03	880 g	1	pc(s)	122	923 117	093478	05 03 01 01	42 g	10	pc(s)	172
787 836	491762	05 02 03 03	880 g	1	pc(s)	122	923 118	104969	05 03 01 01	38 g	10	pc(s)	172
787 837	491779	05 02 03 03	880 g	1	pc(s)	122	923 119	104976	05 03 01 01	38 g	10	pc(s)	172
787 838	491786	05 02 03 03	880 g	1	pc(s)	122							
787 839	491793	05 02 03 03	880 g	1	pc(s)	122							
787 840	491809	05 02 03 03	880 g	1	pc(s)	122							
787 841	491816	05 02 03 03	880 g	1	pc(s)	122							
787 850	491823	05 02 03 04	2.00 kg	1	pc(s)	120							
787 851	491830	05 02 03 04	2.00 kg	1	pc(s)	120							

Variant No.	GTIN*	PG	Weight	PU	SU	Page	Variant No.	GTIN*	PG	Weight	PU	SU	Page
V1KPXFR	165427	05 00 04 04	9.85 kg	1	pc(s)	80	VGJD2QX	165373	05 00 04 04	3.00 kg	1	pc(s)	80
V1RC3P2	163737	05 00 04 13	587 g	1	pc(s)	87	VGM214B	164017	05 00 04 02	2.01 kg	1	pc(s)	69
V2KWXUL	165588	05 00 04 04	4.99 kg	1	pc(s)	81	VGUVRRG	164000	05 00 04 02	1.67 kg	1	pc(s)	69
V2WPYVF	165601	05 00 04 04	8.06 kg	1	pc(s)	81	VH8QTCZ	163775	05 00 04 14	5.43 kg	1	pc(s)	89
V3CM9FR	165687	05 00 04 04	8.31 kg	1	pc(s)	81	VH95BZZ	165274	05 00 04 02	3.54 kg	1	pc(s)	69
V3NC SHX	164031	05 00 04 02	3.44 kg	1	pc(s)	69	VHBWUNH	163645	05 00 04 04	7.86 kg	1	pc(s)	80
V3RQASE	163744	05 00 04 13	1.09 kg	1	pc(s)	87	VHNEFQE	450837	05 00 04 10	5.64 kg	1	pc(s)	82
V3WJMY	163676	05 00 04 04	3.65 kg	1	pc(s)	80	VHV1NKR	164147	05 00 04 02	10.00 kg	1	pc(s)	70
V4RJ7A2	165526	05 00 04 04	5.76 kg	1	pc(s)	81	VJ7VGZD	163553	05 00 04 02	2.67 kg	1	pc(s)	69
V4YPRGE	165243	05 00 04 02	1.14 kg	1	pc(s)	68	VJ13VWW	162136	05 00 04 02	2.27 kg	1	pc(s)	68
V5DHK24	461970	05 00 04 10	10.00 kg	1	pc(s)	82	VKB2Q6J	163829	05 00 04 14	5.58 kg	1	pc(s)	89
V5SVXPH	164727	05 00 04 04	6.33 kg	1	pc(s)	80	VKVBG8W	360136	05 00 04 05	1.51 kg	1	pc(s)	68
V5VN56Z	165465	05 00 04 04	4.81 kg	1	pc(s)	81	VKZLVU3	165502	05 00 04 04	7.90 kg	1	pc(s)	81
V6VE249	164185	05 00 04 02	10.00 kg	1	pc(s)	70	VL2FG28	450820	05 00 04 10	5.68 kg	1	pc(s)	82
V7GN8WU	162389	05 00 04 02	4.62 kg	1	pc(s)	69	VLB2F3G	163607	05 00 04 02	3.83 kg	1	pc(s)	69
V8D4AQ2	163485	05 00 04 02	6.04 kg	1	pc(s)	69	VLL6JWS	163348	05 00 04 02	6.08 kg	1	pc(s)	68
V8MCNWM	165441	05 00 04 04	4.14 kg	1	pc(s)	81	VM2J7S3	165281	05 00 04 02	5.05 kg	1	pc(s)	69
V8PPJEF	165649	05 00 04 04	3.67 kg	1	pc(s)	81	VMBDCM1	165519	05 00 04 04	5.09 kg	1	pc(s)	81
V8VF7CP	165458	05 00 04 04	4.66 kg	1	pc(s)	81	VMLM2BZ	165489	05 00 04 04	6.44 kg	1	pc(s)	81
V9JF26K	163294	05 00 04 02	2.09 kg	1	pc(s)	68	VMRSJWD	163805	05 00 04 12	1.10 kg	1	pc(s)	85
V11E77B	163515	05 00 04 02	5.52 kg	1	pc(s)	69	VMZDL8N	165625	05 00 04 04	2.75 kg	1	pc(s)	81
V18JQHQ	163546	05 00 04 02	1.91 kg	1	pc(s)	69	VN35H5D	163560	05 00 04 02	2.19 kg	1	pc(s)	69
V27E2GP	163980	05 00 04 02	7.89 kg	1	pc(s)	69	VN63A91	163812	05 00 04 14	5.40 kg	1	pc(s)	89
V43FCV8	165571	05 00 04 04	10.00 kg	1	pc(s)	81	VNC1S9W	163539	05 00 04 02	1.56 kg	1	pc(s)	69
V76D5TH	164178	05 00 04 02	10.00 kg	1	pc(s)	70	VNRLBXU	450868	05 00 04 10	10.00 kg	1	pc(s)	83
V93UVAP	164024	05 00 04 02	2.42 kg	1	pc(s)	69	VP6YV4T	162686	05 00 04 14	6.13 kg	1	pc(s)	89
V162LDM	162655	05 00 04 12	1.38 kg	1	pc(s)	84	VP33XYL	450875	05 00 04 10	10.00 kg	1	pc(s)	83
V291ZZT	163997	05 00 04 02	9.39 kg	1	pc(s)	69	VPH98CT	165472	05 00 04 04	5.75 kg	1	pc(s)	81
V797FE6	163188	05 00 04 02	6.65 kg	1	pc(s)	68	VPHPV2	163379	05 00 04 02	1.55 kg	1	pc(s)	68
V7265NS	163355	05 00 04 02	1.04 kg	1	pc(s)	68	VPZBBSL	163317	05 00 04 02	4.03 kg	1	pc(s)	68
V8115WA	163508	05 00 04 02	4.60 kg	1	pc(s)	69	VQ7PF5A	164154	05 00 04 02	1.86 kg	1	pc(s)	70
VA3926J	165403	05 00 04 04	6.81 kg	1	pc(s)	80	VQKTK4T	163768	05 00 04 14	5.23 kg	1	pc(s)	89
VAB3PJV	165410	05 00 04 04	7.80 kg	1	pc(s)	80	VQY44GL	165656	05 00 04 04	4.51 kg	1	pc(s)	81
VABRSSE	164048	05 00 04 02	6.65 kg	1	pc(s)	69	VQYP8B2	163195	05 00 04 04	7.15 kg	1	pc(s)	80
VACNL P8	165540	05 00 04 04	7.51 kg	1	pc(s)	81	VRAB9WB	165533	05 00 04 04	6.72 kg	1	pc(s)	81
VAM7M6H	165267	05 00 04 02	4.25 kg	1	pc(s)	68	VRDSN66	163669	05 00 04 04	3.29 kg	1	pc(s)	80
VANH53Y	461987	05 00 04 10	10.00 kg	1	pc(s)	83	VRJG23Y	163300	05 00 04 02	2.93 kg	1	pc(s)	68
VB1DETL	165632	05 00 04 04	1.53 kg	1	pc(s)	81	VRP32FL	165595	05 00 04 04	6.12 kg	1	pc(s)	81
VB53TC9	163270	05 00 04 02	8.23 kg	1	pc(s)	68	VS B29AH	162662	05 00 04 13	805 g	1	pc(s)	87
VCEY1U6	165397	05 00 04 04	5.33 kg	1	pc(s)	80	VSHDQZB	163836	05 00 04 13	1.71 kg	1	pc(s)	86
VD28FAD	165434	05 00 04 04	3.94 kg	1	pc(s)	80	VSJ3Y6N	461994	05 00 04 10	10.00 kg	1	pc(s)	83
VDXTBGF	164192	05 00 04 02	10.00 kg	1	pc(s)	70	VSUN6NV	163782	05 00 04 13	1.56 kg	1	pc(s)	86
VDZ2VDX	163843	05 00 04 13	1.38 kg	1	pc(s)	87	VSY71K4	163287	05 00 04 02	982 g	1	pc(s)	68
VE5E8FZ	165557	05 00 04 04	3.20 kg	1	pc(s)	81	VTCS2XV	163584	05 00 04 02	2.83 kg	1	pc(s)	69
VE5K3HM	162679	05 00 04 12	1.53 kg	1	pc(s)	84	VTJKEZU	165250	05 00 04 02	2.99 kg	1	pc(s)	68
VE5MT89	163522	05 00 04 02	1.24 kg	1	pc(s)	69	VTSY9XH	163621	05 00 04 04	6.40 kg	1	pc(s)	80
VE9HQHJ	165496	05 00 04 04	7.91 kg	1	pc(s)	81	VU8P6LE	165380	05 00 04 04	4.38 kg	1	pc(s)	80
VEH4JQY	163850	05 00 04 12	1.25 kg	1	pc(s)	85	VUKMT58	163799	05 00 04 13	1.25 kg	1	pc(s)	87
VF33XR2	165564	05 00 04 04	10.00 kg	1	pc(s)	81	VV7M6CQ	461963	05 00 04 10	10.00 kg	1	pc(s)	82
VFV1Z7K	163331	05 00 04 02	5.07 kg	1	pc(s)	68	VVL7AKP	164130	05 00 04 02	10.00 kg	1	pc(s)	70
VFZ17TJ	165663	05 00 04 04	5.68 kg	1	pc(s)	81	VWBDMP5	165670	05 00 04 04	7.12 kg	1	pc(s)	81
VG3V6T2	165298	05 00 04 02	7.32 kg	1	pc(s)	69	VZC3FST	163324	05 00 04 02	5.47 kg	1	pc(s)	68
VG4GXHQ	165618	05 00 04 04	10.00 kg	1	pc(s)	81	VZKQZB5	164161	05 00 04 02	2.28 kg	1	pc(s)	70
VGCMAA5	162518	05 00 04 02	10.00 kg	1	pc(s)	70	VZL6TGH	163362	05 00 04 02	1.31 kg	1	pc(s)	68
VGHVBP5	360389	05 00 04 05	1.12 kg	1	pc(s)	68	VZPW9LG	163751	05 00 04 12	675 g	1	pc(s)	85

Type	Part No.	Page	Type	Part No.	Page	Type	Part No.	Page
AB 32 46 RW K L...	700 099	29	APG XT 11 APC 2 150	785 834	127	APJ OD OG 25	787 813	121
AD EP TI M10	745 022	87	APG XT 11 L APC 1 150	785 864	127	APJ OD OG 26	787 814	121
AD ES SQ SK	765 001	78	APG XT 11 L APC 2 150	785 844	127	APJ OD OG 27	787 815	121
AD ES SQ SK	765 001	83	APG XT 12 APC 1 150	785 855	127	APJ OD OG 28	787 816	121
AD ES SQ SQL	765 006	79	APG XT 12 APC 2 150	785 835	127	APJ OD OG 29	787 817	121
AD FB18 7 STK SN7007	766 321	23	APG XT 12 L APC 1 150	785 865	127	APJ OD OG 30	787 818	121
AD HV STK SQ	766 313	55	APG XT 12 L APC 2 150	785 845	127	APJ OD OG 42	787 800	120
AD M12 STK 30 350	766 352	102	APG XT 13 APC 1 150	785 856	127	APJ OD OG 44	787 801	120
AD PHE4 STK 410	783 930	102	APG XT 13 APC 2 150	785 836	127	APJ OD OG 46	787 350	120
AD SQ ZK 165	766 396	25	APG XT 13 L APC 1 150	785 866	127	APJ OD OG 48	787 351	120
ADS ZK 185	766 389	25	APG XT 13 L APC 2 150	785 846	127	APJ OD OG 50	787 352	120
AD ZK 3M 170	766 059	155	APHO	785 760	134	APJ OD OG 52	787 353	120
AD ZK 25 200	766 055	102	APJ 46	785 769	126	APJ OD OG 54	787 354	120
AD ZK 185	766 392	25	APJ 48	785 770	126	APJ OD OG 56	787 355	120
AD ZK STK 30 360	766 359	24	APJ 50	785 771	126	APJ OD OG 58	787 356	120
AD ZK STK 30 360	766 359	102	APJ 52	785 772	126	APJ OD OG 60	787 357	120
AH ISMTC	766 038	101	APJ 54	785 773	126	APJ OD OG 62	787 358	120
AK 25 ESH STK SN7361	766 372	154	APJ 56	785 774	126	APJ OD OG 64	787 802	120
AK 36 SK STK 330	766 364	23	APJ 58	785 775	126	APJ OD OG 66	787 803	120
AK 36 SK STK 330	766 364	100	APJ 63C 2XL	787 374	124	APJ OD OG 68	787 804	120
AK 36 SQ STK 360	766 365	23	APJ 63C 3XL	787 375	124	APJ OD OG 90	787 820	121
AK 36 SQ STK 360	766 365	100	APJ 63C 4XL	787 376	124	APJ OD OG 94	787 821	121
AK AH ZK ISMTC	766 049	101	APJ 63C L	787 372	124	APJ OD OG 98	787 822	121
AK SK24 SK12	763 712	28	APJ 63C M	787 371	124	APJ OD OG 102	787 823	121
APA B 80	785 377	123	APJ 63C S	787 370	124	APJ OD OG 106	787 824	121
APA B 90	785 370	123	APJ 63C XL	787 373	124	APJ OD OG 110	787 825	121
APA B 100	785 371	123	APJ ID 22	787 610	115	APJ OD OG 114	787 826	121
APA B 110	785 372	123	APJ ID 23	787 611	115	APJ OD OG 118	787 827	121
APA B 120	785 373	123	APJ ID 24	787 612	115	APJ OD OG F 34	787 830	122
APA B 130	785 374	123	APJ ID 25	787 613	115	APJ OD OG F 36	787 831	122
APA B 140	785 375	123	APJ ID 26	787 614	115	APJ OD OG F 38	787 832	122
APA B 150	785 376	123	APJ ID 27	787 615	115	APJ OD OG F 40	787 833	122
APA B	785 788	126	APJ ID 28	787 616	115	APJ OD OG F 42	787 834	122
APA KP	785 789	126	APJ ID 29	787 617	115	APJ OD OG F 44	787 835	122
APB APC2 29C	785 790	133	APJ ID 30	787 618	115	APJ OD OG F 46	787 836	122
APC 48 50	785 755	125	APJ ID 42	787 600	114	APJ OD OG F 48	787 837	122
APC 52 54	785 756	125	APJ ID 44	787 601	114	APJ OD OG F 50	787 838	122
APC 56 58	785 757	125	APJ ID 46	785 330	114	APJ OD OG F 52	787 839	122
APC 60 62	785 758	125	APJ ID 48	785 331	114	APJ OD OG F 54	787 840	122
APC 64 66	785 759	125	APJ ID 50	785 332	114	APJ OD OG F 56	787 841	122
APD 63C 2XL	787 384	125	APJ ID 52	785 333	114	APJ OD YE 22	787 710	118
APD 63C 3XL	787 385	125	APJ ID 54	785 334	114	APJ OD YE 23	787 711	118
APD 63C 4XL	787 386	125	APJ ID 56	785 335	114	APJ OD YE 24	787 712	118
APD 63C L	787 382	125	APJ ID 58	785 336	114	APJ OD YE 25	787 713	118
APD 63C M	787 381	125	APJ ID 60	785 337	114	APJ OD YE 26	787 714	118
APD 63C S	787 380	125	APJ ID 62	785 338	114	APJ OD YE 27	787 715	118
APD 63C XL	787 383	125	APJ ID 64	787 602	114	APJ OD YE 28	787 716	118
APG 8	785 796	128	APJ ID 66	787 603	114	APJ OD YE 29	787 717	118
APG 8 L	785 808	128	APJ ID 68	787 604	114	APJ OD YE 30	787 718	118
APG 9	785 797	128	APJ ID 90	787 620	115	APJ OD YE 42	787 700	117
APG 9 L	785 809	128	APJ ID 94	787 621	115	APJ OD YE 44	787 701	117
APG 10	785 798	128	APJ ID 98	787 622	115	APJ OD YE 46	785 350	117
APG 10 L	785 810	128	APJ ID 102	787 623	115	APJ OD YE 48	785 351	117
APG 11	785 799	128	APJ ID 106	787 624	115	APJ OD YE 50	785 352	117
APG 11 L	785 811	128	APJ ID 110	787 625	115	APJ OD YE 52	785 353	117
APG 12	785 800	128	APJ ID 114	787 626	115	APJ OD YE 54	785 354	117
APG 12 L	785 812	128	APJ ID 118	787 627	115	APJ OD YE 56	785 355	117
APG XT 7 APC 1 150	785 850	127	APJ ID F 34	787 630	116	APJ OD YE 58	785 356	117
APG XT 7 APC 2 150	785 830	127	APJ ID F 36	787 631	116	APJ OD YE 60	785 357	117
APG XT 7 L APC 1 150	785 860	127	APJ ID F 38	787 632	116	APJ OD YE 62	785 358	117
APG XT 7 L APC 2 150	785 840	127	APJ ID F 40	787 633	116	APJ OD YE 64	787 702	117
APG XT 8 APC 1 150	785 851	127	APJ ID F 42	787 634	116	APJ OD YE 66	787 703	117
APG XT 8 APC 2 150	785 831	127	APJ ID F 44	787 635	116	APJ OD YE 68	787 704	117
APG XT 8 L APC 1 150	785 861	127	APJ ID F 46	787 636	116	APJ OD YE 90	787 720	118
APG XT 8 L APC 2 150	785 841	127	APJ ID F 48	787 637	116	APJ OD YE 94	787 721	118
APG XT 9 APC 1 150	785 852	127	APJ ID F 50	787 638	116	APJ OD YE 98	787 722	118
APG XT 9 APC 2 150	785 832	127	APJ ID F 52	787 639	116	APJ OD YE 102	787 723	118
APG XT 9 L APC 1 150	785 862	127	APJ ID F 54	787 640	116	APJ OD YE 106	787 724	118
APG XT 9 L APC 2 150	785 842	127	APJ ID F 56	787 641	116	APJ OD YE 110	787 725	118
APG XT 10 APC 1 150	785 853	127	APJ ID KONFI	785 339	116	APJ OD YE 114	787 726	118
APG XT 10 APC 2 150	785 833	127	APJ OD KONFI	785 359	122	APJ OD YE 118	787 727	118
APG XT 10 L APC 1 150	785 863	127	APJ OD OG 22	787 810	121	APJ OD YE F 34	787 730	119
APG XT 10 L APC 2 150	785 843	127	APJ OD OG 23	787 811	121	APJ OD YE F 36	787 731	119
APG XT 11 APC 1 150	785 854	127	APJ OD OG 24	787 812	121	APJ OD YE F 38	787 732	119

Type	Part No.	Page	Type	Part No.	Page	Type	Part No.	Page
APJ OD YE F 40	787 733	119	APT ID F 54	787 690	116	APT OD YE 106	787 774	118
APJ OD YE F 42	787 734	119	APT ID F 56	787 691	116	APT OD YE 110	787 775	118
APJ OD YE F 44	787 735	119	APT ID KONFI	785 349	116	APT OD YE 114	787 776	118
APJ OD YE F 46	787 736	119	APT OD KONFI	785 369	122	APT OD YE 118	787 777	118
APJ OD YE F 48	787 737	119	APT OD OG 22	787 860	121	APT OD YE F 34	787 780	119
APJ OD YE F 50	787 738	119	APT OD OG 23	787 861	121	APT OD YE F 36	787 781	119
APJ OD YE F 52	787 739	119	APT OD OG 24	787 862	121	APT OD YE F 38	787 782	119
APJ OD YE F 54	787 740	119	APT OD OG 25	787 863	121	APT OD YE F 40	787 783	119
APJ OD YE F 56	787 741	119	APT OD OG 26	787 864	121	APT OD YE F 42	787 784	119
APPS BC 2XL	787 006	123	APT OD OG 27	787 865	121	APT OD YE F 44	787 785	119
APPS BC 3XL	787 007	123	APT OD OG 28	787 866	121	APT OD YE F 46	787 786	119
APPS BC 4XL	787 008	123	APT OD OG 29	787 867	121	APT OD YE F 48	787 787	119
APPS BC L	787 004	123	APT OD OG 30	787 868	121	APT OD YE F 50	787 788	119
APPS BC M	787 003	123	APT OD OG 42	787 850	120	APT OD YE F 52	787 789	119
APPS BC S	787 002	123	APT OD OG 44	787 851	120	APT OD YE F 54	787 790	119
APPS BC XL	787 005	123	APT OD OG 46	787 360	120	APT OD YE F 56	787 791	119
APPS BC XS	787 001	123	APT OD OG 48	787 361	120	APUP 2XL	787 026	124
APS ARC E1 SK7	785 870	133	APT OD OG 50	787 362	120	APUP 3XL	787 027	124
APS CL1 MEHA	785 721	134	APT OD OG 52	787 363	120	APUP 4XL	787 028	124
APS CL2 MAHA	785 722	134	APT OD OG 54	787 364	120	APUP L	787 024	124
APS T AS 14C FS	785 825	132	APT OD OG 56	787 365	120	APUP M	787 023	124
APS T AS 14C SC	785 822	132	APT OD OG 58	787 366	120	APUP S	787 022	124
APS T AS 25C FS	785 826	132	APT OD OG 60	787 367	120	APUP XL	787 025	124
APS T AS 25C SC	785 823	132	APT OD OG 62	787 368	120	APUP XS	787 021	124
APS T AS CL2 FS	785 824	132	APT OD OG 64	787 852	120	APUS 2XL	787 016	124
APS T AS CL2 SC	785 821	132	APT OD OG 66	787 853	120	APUS 3XL	787 017	124
APT 46	785 779	126	APT OD OG 68	787 854	120	APUS 4XL	787 018	124
APT 48	785 780	126	APT OD OG 90	787 870	121	APUS L	787 014	124
APT 50	785 781	126	APT OD OG 94	787 871	121	APUS M	787 013	124
APT 52	785 782	126	APT OD OG 98	787 872	121	APUS S	787 012	124
APT 54	785 783	126	APT OD OG 102	787 873	121	APUS XL	787 015	124
APT 56	785 784	126	APT OD OG 106	787 874	121	APUS XS	787 011	124
APT 58	785 785	126	APT OD OG 110	787 875	121	ARS 65 40	785 443	137
APT ID 22	787 660	115	APT OD OG 114	787 876	121	AR STK	766 889	55
APT ID 23	787 661	115	APT OD OG 118	787 877	121	ASKT GBSW 10 M KST	700 113	30
APT ID 24	787 662	115	APT OD OG F 34	787 880	122	ASKT RTWS 10 M KST	700 112	30
APT ID 25	787 663	115	APT OD OG F 36	787 881	122	ASPS 110 132 16.7 L	767 565	160
APT ID 26	787 664	115	APT OD OG F 38	787 882	122	ASPS 110 420 L	767 571	41
APT ID 27	787 665	115	APT OD OG F 40	787 883	122	ASPS 110 420 S	767 572	41
APT ID 28	787 666	115	APT OD OG F 42	787 884	122	ASPS 110 420 S L	767 573	41
APT ID 29	787 667	115	APT OD OG F 44	787 885	122	AS SCHR M12 55	705 500	65
APT ID 30	787 668	115	APT OD OG F 46	787 886	122	AS SCHR M12 M12 40	705 504	65
APT ID 42	787 650	114	APT OD OG F 48	787 887	122	AS SCHR M16 55 M12	705 510	65
APT ID 44	787 651	114	APT OD OG F 50	787 888	122	AS SCHR M16 65	750 500	65
APT ID 46	785 340	114	APT OD OG F 52	787 889	122	AS SCHW M12 25	705 501	65
APT ID 48	785 341	114	APT OD OG F 54	787 890	122	AS SCHW M12	336 020	65
APT ID 50	785 342	114	APT OD OG F 56	787 891	122	AS SCHW M16 30	755 501	65
APT ID 52	785 343	114	APT OD YE 22	787 760	118	AS SCHW M16	336 025	65
APT ID 54	785 344	114	APT OD YE 23	787 761	118	ASSN 36 STK ZK	766 380	25
APT ID 56	785 345	114	APT OD YE 24	787 762	118	ASSN 36 STK ZK	766 380	155
APT ID 58	785 346	114	APT OD YE 25	787 763	118	A STK	766 888	55
APT ID 60	785 347	114	APT OD YE 26	787 764	118	AT 50 30	785 442	137
APT ID 62	785 348	114	APT OD YE 27	787 765	118	AT IHS NS	785 490	129
APT ID 64	787 652	114	APT OD YE 28	787 766	118	AT IHS NS	785 490	130
APT ID 66	787 653	114	APT OD YE 29	787 767	118	ATK 120 25M NS	785 467	97
APT ID 68	787 654	114	APT OD YE 30	787 768	118	ATK 120 ..M NS	785 468	97
APT ID 90	787 670	115	APT OD YE 42	787 750	117	ATK 135 50M NS	785 465	97
APT ID 94	787 671	115	APT OD YE 44	787 751	117	ATK 135 ..M NS	785 466	97
APT ID 98	787 672	115	APT OD YE 46	785 360	117	ATN 140 10M NS	785 471	98
APT ID 102	787 673	115	APT OD YE 48	785 361	117	ATN 140 ..M NS	785 472	98
APT ID 106	787 674	115	APT OD YE 50	785 362	117	AT SPN II	766 543	45
APT ID 110	787 675	115	APT OD YE 52	785 363	117			
APT ID 114	787 676	115	APT OD YE 54	785 364	117	BEV 2XUKH 70 8500AL	752 192	170
APT ID 118	787 677	115	APT OD YE 56	785 365	117	BEV BM HZ BDW K	751 193	170
APT ID F 34	787 680	116	APT OD YE 58	785 366	117	BEV BM HZ BDW R	751 197	170
APT ID F 36	787 681	116	APT OD YE 60	785 367	117	BEV MF LTE	751 192	170
APT ID F 38	787 682	116	APT OD YE 62	785 368	117	BEV MF SE K	751 191	170
APT ID F 40	787 683	116	APT OD YE 64	787 752	117	BEV MF SE R	751 196	170
APT ID F 42	787 684	116	APT OD YE 66	787 753	117	BEV OL NPF K	750 210	165
APT ID F 44	787 685	116	APT OD YE 68	787 754	117	BEV OL NPF PKW K	750 196	166
APT ID F 46	787 686	116	APT OD YE 90	787 770	118	BEV OL NPF PKW R	750 216	166
APT ID F 48	787 687	116	APT OD YE 94	787 771	118	BEV OL NPF R	750 218	165
APT ID F 50	787 688	116	APT OD YE 98	787 772	118	BEV OL PF K	750 211	165
APT ID F 52	787 689	116	APT OD YE 102	787 773	118	BEV OL PF PKW K	750 200	166

Type	Part No.	Page	Type	Part No.	Page	Type	Part No.	Page
BEV OL PF PKW R	750 217	166	EKS 50 BEV 4M	751 040	171	EKV3+1 95 G VE9HQHJ	VE9HQHJ	81
BEV OL PF R	750 219	165	EKS 50 BEV 8.5M	751 085	171	EKV3+1 95 R V5SVXPH	V5SVXPH	80
BEV OL PF V2 K	750 214	166	EKS 50 BEV 12M	751 120	171	EKV3+1 95 R VRAB9WB	VRAB9WB	81
BEV OL PF V2 R	750 221	166	EKS 50 BEV 13M	751 130	171	EKV3+1 120 G VAB3PJV	VAB3PJV	80
BEV SVUL	750 213	167	EKS 50 BEV 14M	751 140	171	EKV3+1 120 G VKZLVU3	VKZLVU3	81
BEV UKH K 70 8500AL	752 191	170	EKS B10.5 70 4000AL	752 040	171	EKV3+1 120 R VACNLP8	VACNLP8	81
BEV UKH K 70 12000AL	752 193	170	EKS B10.5 70 8500AL	752 085	171	EKV3+1 120 R VTSY9XH	VTSY9XH	80
BEV UKH R 70 8500AL	752 196	170	EKS B10.5 70 12000AL	752 120	171	EKV3+1 150 G V1KPXFR	V1KPXFR	80
BEV UKH R 70 12000AL	752 197	170	EK SN7089	745 510	85	EKV3+1 150 R VHBWUNH	VHBWUNH	80
BEV US OL ST	750 212	166	EKS TI 2F KVS SBK	745 500	86	EKV3 16TI EK VSB29AH	VSB29AH	87
BEV WHA ZVA	750 215	167	EKS TI KVS SBK	766 302	86	EKV3 16TI HK V3RQASE	V3RQASE	87
BS EP NH1 3 TI	745 506	88	EKS VI 2F KVS KK	745 903	84	EKV3 16VI EK VZPW9LG	VZPW9LG	85
			EKS VI 2F KVS SBK	745 901	84	EKV3 25BS ZK VQKTK4T	VQKTK4T	89
CG-10/S2 A R 8	785 381	129	EKV1+0 16 V4YPRGE	V4YPRGE	68	EKV3 25IS ZK VH8QTCZ	VH8QTCZ	89
CG-10/S2 B R 9	785 382	129	EKV1+0 25 VSY71K4	VSY71K4	68	EKV3 25TI DG VSUN6NV	VSUN6NV	86
CG-10/S2 C R 10	785 383	129	EKV1+0 35 V9JF26K	V9JF26K	68	EKV3 25TI HK VUKMT58	VUKMT58	87
CG-10/S2 D R 11	785 384	129	EKV1+0 35 VGHVBP5	VGHVBP5	68	EKV3 25VI DG V162LDM	V162LDM	84
			EKV1+0 50 VKVBG8W	VKVBG8W	68	EKV3 25VI EK VMRSJWD	VMRSJWD	85
DGF EKV VI	745 921	85	EKV1+0 50 VRJG23Y	VRJG23Y	68	EKV3 35BS ZK VN63A91	VN63A91	89
DGF EKV VI	745 921	88	EKV1+0 70 VPZBBSL	VPZBBSL	68	EKV3 35IS ZK VKB2Q6J	VKB2Q6J	89
DGF EKV VI	745 921	90	EKV1+0 95 VZC3FST	VZC3FST	68	EKV3 35TI DG VSHDQZB	VSHDQZB	86
DP 40 40 B13 AL	525 001	66	EKV1+0 120 V797FE6	V797FE6	68	EKV3 35TI HK VDZ2VDX	VDZ2VDX	87
DP 50 50 B17 AL	525 002	66	EKV1+0 150 VB53TC9	VB53TC9	68	EKV3 35VI DG VE5K3HM	VE5K3HM	84
DR PAG	759 798	99	EKV1+1 16 VE5E8FZ	VE5E8FZ	81	EKV3 35VI EK VEH4JQY	VEH4JQY	85
DR PS PHE3	767 779	99	EKV1+1 16 VMZDL8N	VMZDL8N	81	EKV3 50IS ZK VP6YV4T	VP6YV4T	89
DSRT DD CPS AACA	782 031	148	EKV1+1 25 VB1DETL	VB1DETL	81	EKV3 NH00 TI V1RC3P2	V1RC3P2	87
DSRT DD CPS BACA	782 030	148	EKV1+1 25 VF33XR2	VF33XR2	81	EKV4u0 16 G VGUVRRG	VGUVRRG	69
DSRT DD FS AAAA	782 051	148	EKV1+1 35 V8PPJEF	V8PPJEF	81	EKV4u0 25 G VGM214B	VGM214B	69
DSRT DD FS BAAA	782 050	148	EKV1+1 35 V43FCV8	V43FCV8	81	EKV4u0 35 G V93UVAP	V93UVAP	69
DSRT DD PS AACA	782 041	148	EKV1+1 50 V2KWXUL	V2KWXUL	81	EKV4u0 50 G V3NCSHX	V3NCSHX	69
DSRT DD PS BACA	782 040	148	EKV1+1 50 VQY44GL	VQY44GL	81	EKV4u0 70 G V7GN8WU	V7GN8WU	69
DSRT FC D8	782 099	149	EKV1+1 70 VFZ17TJ	VFZ17TJ	81	EKV4u0 95 G VABRSSE	VABRSSE	69
DSRT FS 8 1.5	782 077	149	EKV1+1 70 VRP32FL	VRP32FL	81	EKV4u0 120 G V27E2GP	V27E2GP	69
DSRT FS 10 1.5	782 081	149	EKV1+1 95 V2WPYVF	V2WPYVF	81	EKV4u0 150 G V291ZZT	V291ZZT	69
DSRT FS 12 1.5	782 085	149	EKV1+1 95 VWBDMPS	VWBDMP5	81	EKV5+0 16 G VQ7PFA	VQ7PFA	70
DSRT FS 15 1.5	782 091	149	EKV1+1 120 V3CM9FR	V3CM9FR	81	EKV5+0 25 G VZKQZB5	VZKQZB5	70
DSRT FS 17 1.5	782 092	149	EKV1+1 120 VG4GXHQ	VG4GXHQ	81	EKV5+0 35 G V76D5TH	V76D5TH	70
DSRT LWL 0.75	782 020	149	EKV2+0 16 G V7265NS	V7265NS	68	EKV5+0 50 G V6VE249	V6VE249	70
DSRT LWL 2.00	782 022	149	EKV2+0 25 G VZL6TGH	VZL6TGH	68	EKV5+0 70 G VDXTBGF	VDXTBGF	70
DSRT LWL 4.00	782 024	149	EKV2+0 35 G VPHPV2	VPHPV2	68	EKV5+0 95 G VGCMAA5	VGCMAA5	70
DSRT LWL 8.00	782 028	149	EKV2+0 50 G VJ13VWW	VJ13VWW	68	EKV5+0 120 G VVL7AKP	VVL7AKP	70
DSRT PS	782 060	148	EKV2+0 70 G VTJKEZU	VTJKEZU	68	EKV5+0 150 G VHV1NKR	VHV1NKR	70
DSRT QD II	782 002	149	EKV2+0 95 G VAM7M6H	VAM7M6H	68	EKV FD K 70 8500AL	752 086	169
DSRT SR D8 L20	782 098	149	EKV2+0 120 G VV1Z7K	VV1Z7K	68	EKV FD K 70 12000AL	752 126	169
			EKV2+0 150 G VLL6JWS	VLL6JWS	68	EKV FD K H70 12000AL	752 121	169
EAB RN 16 FS	790 150	76	EKV2 50 KKH 600 1800	751 150	170	EKV FD R 70 8500AL	752 087	169
EAB RN 16 SKN	790 160	76	EKV3+0 16 G VE5MT89	VE5MT89	69	EKV FD R 70 12000AL	752 127	169
EAP 2 25 KKH HG	728 501	165	EKV3+0 25 G VNC1S9W	VNC1S9W	69	EKV FD R H70 12000AL	752 122	169
EAP 2 25 MA US OL	728 502	165	EKV3+0 35 G V18JQHJ	V18JQHJ	69	EKV K 50 8500	751 086	169
EAP 25 SIT US OL	728 503	165	EKV3+0 50 G VJ7VGZD	VJ7VGZD	69	EKV K 50 12000	751 126	169
EAPA 3 KFP 20 B13	728 522	67	EKV3+0 50 R VN35H5D	VN35H5D	69	EKV K H 50 12000	751 121	169
EAPA 3 KFP 20 KKH	728 620	67	EKV3+0 70 G VH95BZZ	VH95BZZ	69	EKV LK 50 4000	750 042	170
EAPA 3 KFP 25 B13	728 526	67	EKV3+0 70 R VTCS2XV	VTCS2XV	69	EKV LK UKH 70 4000AL	752 042	170
EAPA 3 KFP 25 KKH	728 625	67	EKV3+0 95 G VM2J7S3	VM2J7S3	69	EKV R 50 8500	751 087	169
EAPA 3 RN 16 EAB	728 516	67	EKV3+0 95 R VLB2F3G	VLB2F3G	69	EKV R 50 12000	751 127	169
EAS EK FM 12	775 621	76	EKV3+0 120 G V8D4AQ2	V8D4AQ2	69	EKV R H 50 12000	751 122	169
EAS EK FM 16	775 631	76	EKV3+0 120 R V8115WA	V8115WA	69	EKV ÜGK MB	745 107	90
EAS EK FS 12	775 626	76	EKV3+0 150 G VG3V6T2	VG3V6T2	69	EKV ÜGK MB S	745 105	90
EAS EK FS 16	775 636	76	EKV3+0 150 R V11E77B	V11E77B	69	EKV ÜGK MB SN7354	745 115	90
EB 9V AL	767 713	99	EKV3+1 16 G V8MCNWM	V8MCNWM	81	EKV ÜGK MB SN7724	745 121	90
EB 9V LI	767 712	99	EKV3+1 16 G VGJD2QX	VGJD2QX	80	EKV UK 50 4000	750 041	169
EFK FL30 SKN	792 030	77	EKV3+1 25 G V8VF7CP	V8VF7CP	81	EKV UKQ UKH70 4000AL	752 041	169
EFK FL40 SKN	792 190	76	EKV3+1 25 G VRDSN66	VRDSN66	80	EL 16CU EZ KS8.5	758 216	58
EFP 16 RN M12 35 SSM	790 251	65	EKV3+1 35 G V3WJMY	V3WJMY	80	EL 16CU KS12.5 8.5	758 116	58
EFP 16 RN M12	790 250	65	EKV3+1 35 G V5VN56Z	V5VN56Z	81	EL 25CU KS12.5 8.5	758 125	58
EFP 16 RN M16 45 SSM	790 261	65	EKV3+1 50 G VPH98CT	VPH98CT	81	EL 35CU KS12.5 8.5	758 135	58
EFP 16 RN M16	790 260	65	EKV3+1 50 G VU8P6LE	VU8P6LE	80	EL M8 G PHE	766 924	54
EG 00 4A VI	745 922	85	EKV3+1 50 R VD28FAD	VD28FAD	80	EL M8 H PHE	766 923	54
EG SK STK 400	745 415	91	EKV3+1 50 R VMBDCM1	VMBDCM1	81	EL M8 MAG PHE PHV	766 915	54
EG SQ STK 400	745 414	91	EKV3+1 70 G VCEY1U6	VCEY1U6	80	EL M8 S PHE PHV	766 925	54
EG TI EKV	745 400	88	EKV3+1 70 G VMLM2BZ	VMLM2BZ	81	EL M8 SZ PHE PHV	766 913	54
EHH BEV OL	740 124	171	EKV3+1 70 R V4RJ7A2	V4RJ7A2	81	EL M8 V PHE PHV	766 927	54
EK FL20 FS	745 502	88	EKV3+1 70 R VQYP8B2	VQYP8B2	80	EP NH00 TI M10	745 302	87
EK I FL20 DGF	745 602	88	EKV3+1 95 G VA3926U	VA3926U	80	EP NH00 TI SN7379	745 307	87

Type	Part No.	Page	Type	Part No.	Page	Type	Part No.	Page
EP NH00 VI TA	745 905	85	EV TES 465 KS10	758 022	57	IMG SAN 1M 10M	785 459	97
EP NH1 3 TI GL M10	745 017	87	EV TES 465 SN7215	758 036	58	IMG SAN 1M .M	785 458	97
EP NH1 3 TI M10	745 018	87	EV TES STK 1500	758 085	58	IS 25 ZK RK 3160	766 340	155
EP NH1 3 VI TA	745 910	85	EV TES STK 1500 KS	758 025	57	IS 36 SK 1000	766 001	22
EP NH4A TI M10	745 016	87	EV TS 2000 EK	758 001	57	IS 36 SK 1500	766 002	22
EP NH4A VI TA	745 915	85	EV TS 2000 EZ	758 003	57	IS 36 SK STK 1000	766 100	22
ERO BSP ASSM10 1000 STTZN	644 000	74	EV TS STK 1470	758 075	58	IS 36 SQ 1000	766 311	22
ESOFI G - 1 X 1	787 461	96				IS 36 SQ 1000	766 311	25
ESOFI G - 1 X 2	787 462	96	FD 60 MS SN7271	785 225	108	IS 36 SQ 1500	766 315	22
ESOFI G - 1 X 3	787 463	96	FEK 4 15 TS FSQ L	784 755	168	IS 36 SQ 1500	766 315	25
ESOFI G - 1 X 4	787 464	96	FEK4 15 TS FSQ L AB29	784 756	168	IS 36 SQ STK 1000	766 301	23
ESOFI G - 1 X 5	787 465	96	FLOW SB FO E P CI WRU SRC 36	787 200	131	IS 36 STK 30 1280	766 363	23
ESOFI G - 1 X 6	787 466	96	FLOW SB FO E P CI WRU SRC 37	787 201	131	IS 36 STK 30 1280	766 363	101
ESOFI G - 1 X 7	787 467	96	FLOW SB FO E P CI WRU SRC 38	787 202	131	IS 36 ZK STK 1300	785 325	24
ESOFI G - 1 X 8	787 468	96	FLOW SB FO E P CI WRU SRC 39	787 203	131	IS 72.5 SQ SN7743	766 312	22
ESOFI G - 1 X 9	787 469	96	FLOW SB FO E P CI WRU SRC 40	787 204	131	IS 123 SK STK 2000	766 122	22
ESOFI G - 1 X 10	787 457	96	FLOW SB FO E P CI WRU SRC 41	787 205	131	IS 123 SQ STK 2000	766 322	23
ES 3P FL ER	799 009	74	FLOW SB FO E P CI WRU SRC 42	787 206	131	IS 123 SQ STK 2000	766 322	25
ES4FI G - 1 X 1	787 471	96	FLOW SB FO E P CI WRU SRC 43	787 207	131	ISK MS QS 6 35 L100	700 120	98
ES4FI G - 1 X 2	787 472	96	FLOW SB FO E P CI WRU SRC 44	787 208	131	ISK MS QS 10 50 L100	700 121	98
ES4FI G - 1 X 3	787 473	96	FLOW SB FO E P CI WRU SRC 45	787 209	131	ISK MS QS 35 95 L110	700 122	98
ES4FI G - 1 X 4	787 474	96	FLOW SB FO E P CI WRU SRC 46	787 210	131	IS M12 AK 635	766 328	101
ES4FI G - 1 X 5	787 475	96	FLOW SB FO E P CI WRU SRC 47	787 211	131	IS M12 STK 640	766 331	101
ES4FI G - 1 X 6	787 476	96	FR A10 V2A	524 910	66	ISMTC N 36 ZK 10600	766 037	39
ES4FI G - 1 X 7	787 477	96	FR A12 V2A	524 912	66	ISMTC N 36 ZK 10600	766 037	101
ES4FI G - 1 X 8	787 478	96	FR A16 V2A	524 913	66	ISN 25 STK 900SN7360	766 371	154
ES4FI G - 1 X 9	787 479	96	FRS ZK MS	785 940	105	ISN 36 SK STK 1000	766 111	22
ES4FI G - 1 X 10	787 459	96	FSG PHE	767 776	99	ISN 36 SQ STK 1000	766 301	23
ESE E27 KBI M10	745 203	88	FSG PHG2 PHV	767 777	99	ISN 36 STK 30 1280	766 367	23
ESE E27 TI M10	745 201	88	FWD 35 P NS	785 592	108	ISN 36 STK 30 1280	766 367	101
ESE E33 KBI M10	745 204	88				ISN 36 STK 930SN7688	766 362	23
ESE E33 TI M10	745 202	88	GL 3.5V 0.2A E10	766 605	99	ISN 36 STK 930SN7688	766 362	101
ESH U 1000 S SB	785 708	135	GR PAG	759 799	99	ISN 123 SQ STK 2500	766 332	23
ESH U 1000 S SO	785 707	135				ISO M12 STK 30SN7563	766 116	102
ESH U 1000 S SR	785 709	135	H AB 32 46 K	700 098	29	ISP 36 PVC A1...	763 211	95
ESH U 1000 S SW	785 706	135	HG ZK 230	766 393	24	ISP 36 PVC A2...	763 221	95
ESH U 1000 S SY	785 705	135	HISC 1600	785 310	108	ISP 36 PVC A3...	763 231	95
ESP HVS 1500	799 006	75	HK 8 NS	785 648	98	ISP 36 PVC A4...	763 241	95
ESS 3P M10 FM	799 019	74	HOEL 36 20 1100	785 399	109	IS PHE4 STK 700	783 900	101
ES SK 1000	761 010	77	HSA194 110 420 16.7	767 542	161	IS PHE4 STK 770	783 905	101
ES SK 1500	761 015	77	HSA 194 110 420 SN7737	767 539	42	IS PHE4 STK 1110	783 906	101
ES SK STK 1000	761 001	77	HSA194 110 420 STK	767 541	42	IS SK12 HK 1720	763 710	28
ES SK STK 2000	761 003	77	HSA205 U 1 420SN7608	767 547	43	IS T 36 ZK STK 1300	785 315	24
ES SQ 1000	761 011	77	HSA205 U 1 420 STK	767 552	43	ISU STK STK 30SN7564	766 117	102
ES SQ 1500	761 016	77	H STK 43 500	766 520	102	ISV 36 STK 30 910	766 356	25
ES SQ STK 1000	761 002	78	H STK 43 800	766 120	102	ISV 36 STK 30 910	766 356	102
ES SQ STK 2000	761 004	78	HV 3HH	700 015	27	ISV 36 STK 30 1280	766 366	25
ESTC PSK 5000 SN7249	769 511	73	HV 3HH ET	700 005	27	ISV 36 STK 30 1280	766 366	102
ESTC SQL 4000	769 400	79	HV 3HH SZ	700 014	27	ISV 220 ZK 123 SN7739	785 311	25
ESTC SQL 5000	769 500	79	HV 3HH SZ ET	700 004	27	ISV 220 ZK MS	785 316	25
ESTC SQL H RW 5000	769 508	166	HV EKV ES30	700 000	55	ISV 320 ZK 123 SN7740	785 312	25
ESTC SQL RW 3500	769 352	167	HV EKV ES30	700 000	91	ISV 320 ZK MS	785 317	25
ESTC SQL RW 5000	769 502	167	HV EKV ES30 1500	700 003	55	ISV 420 ZK 123 SN7741	785 313	25
ESTC SQL STK 3000	769 300	79	HV EKV ES30 1500	700 003	91	ISV 420 ZK MS	785 318	25
ESTC SQ STK SN7562	769 304	78	HV EKV ES40	700 002	55	ISV 820 ZK 123 SN7742	785 314	25
EST ES 1500	769 505	79	HV EKV ES40	700 002	91	ISV 820 ZK MS	785 319	25
EST KS SQL 1500	769 503	79	HV P ST D24	700 006	55	ISV PHE4 43 1100	783 945	102
EST SK STK 920	761 070	78	HV P ST D24	700 006	91	ISV SK12 1060	763 711	28
EST SQL RW 4855 TA	769 515	167	HV P ST D30	700 007	55	IS ZK STK 670	766 368	39
EST SQ STK 920	761 075	78	HV P ST D30	700 007	91	IS ZK STK 670	766 368	101
EST ZS 1500	769 504	79	HV P ST D40 45	700 008	55	IS ZK STK HS 670	766 369	101
ES YM2 16	716 001	68	HV P ST D40 45	700 008	91	IT M12 STK 30 1150	766 115	102
ES YM2 25	725 001	68	HV STK 30 710	766 335	25	IT PHE4 STK 760	783 920	102
ES YM2 35	735 001	68	HV STK 30 710	766 335	102	IT PHE4 STK 1210	783 925	102
ES YM2 50	750 001	68	HV STK 43 910	766 456	25	IT ZK30 STK 30 360	766 358	102
ES YM2 70	770 001	68	HV STK 43 910	766 456	102			
ES YM2 95	795 001	68	HV STK 43 975	766 077	102	KC-AI-8-36-S	787 490	129
ES YM2 120	712 001	68	HV STK 43 1045	766 076	102	KC-AI-9-36-S	787 491	129
ES YM2 150	715 001	68	HV STK 43 1280	766 466	25	KC-AI-10-36-S	787 492	129
EV EH 1725 EK	758 015	57	HV STK 43 1280	766 466	102	KC-AI-11-36-S	787 493	129
EV EHB 1600 SN7114	758 028	58	HV STK 43 2350	766 073	102	KC-BI-8-36-S	787 494	129
EV EHB STK 1600	758 095	58	HVTC STK 4100 SN7359	766 469	154	KC-BI-9-36-S	787 495	129
EV TES 465 EK	758 020	57				KC-BI-10-36-S	787 496	129
EV TES 465 EZ	758 021	57				KC-BI-11-36-S	787 497	129

Type	Part No.	Page	Type	Part No.	Page	Type	Part No.	Page
KFP 20 M10	754 205	63	KL-A-10-36-S	787 482	129	NHS AG 00 3 NS	785 645	128
KFP 20 M12 35 SSM	754 235	63	KL-A-11-36-S	787 483	129	OEK 12 NS	785 649	98
KFP 20 M12 45 SN7078	754 238	63	KL-B-8-36-S	787 484	129	PAP 2 M12 SSM B13	728 312	74
KFP 20 M12	754 200	63	KL-B-9-36-S	787 485	129	PAP 3 M12 SSM B13 RB	728 313	74
KFP 20 M16 45 SSM	754 645	63	KL-B-10-36-S	787 486	129	PAS EK SQ 16	771 316	72
KFP 20 M16	754 600	63	KL-B-11-36-S	787 487	129	PAV 3+1 16 ZAK	758 099	58
KFP 20 S AL 12	706 300	63	KL-C-8-41-S	787 100	130	PHE3 3 10 S	767 711	37
KFP 20 W45 M12 35SSM	706 235	64	KL-C-9-41-S	787 101	130	PHE3 3 10 S ZK	767 941	38
KFP 20 W45 M12	706 200	64	KL-C-10-41-S	787 102	130	PHE3 3 S ZK	767 903	38
KFP 20 W45M12 SN7024	706 239	64	KL-C-11-41-S	787 103	130	PHE3 6 20 S	767 721	37
KFP 20 W45 M16 45SSM	706 645	64	KL-D-8-41-S	787 104	130	PHE3 6 20 SL	767 740	37
KFP 20 W45 M16	706 600	64	KL-D-9-41-S	787 105	130	PHE3 6 20 SL ZK	767 940	38
KFP 20 W90 M12 35SSM	707 235	64	KL-D-10-41-S	787 106	130	PHE3 6 20 S ZK	767 951	38
KFP 20 W90 M12	707 200	64	KL-D-11-41-S	787 107	130	PHE3 6 S	767 706	37
KFP 20 W90 M16 45SSM	707 645	64	KL-E-8-41-S	787 108	130	PHE3 6 S ZK	767 906	38
KFP 20 W90 M16	707 600	64	KL-E-9-41-S	787 109	130	PHE3 10 30 S	767 731	37
KFP 25 M12 25 SSM	755 225	63	KL-E-10-41-S	787 110	130	PHE3 10 30 SL	767 750	37
KFP 25 M12 35 SKM	755 627	164	KL-E-11-41-S	787 111	130	PHE3 10 30 SL ZK	767 950	38
KFP 25 M12 45 SSM	755 245	63	KL-F-9-41-S	787 112	130	PHE3 10 30 S ZK	767 961	38
KFP 25 M12	755 200	63	KL-F-10-41-S	787 113	130	PHE3 10 S	767 710	37
KFP 25 M16 25	755 636	164	KL-F-11-41-S	787 114	130	PHE3 10 S ZK	767 910	38
KFP 25 M16 25 SKM	755 626	164	KLFP M16 KSS	795 020	83	PHE3 20 S	767 720	37
KFP 25 M16 45 SKM	755 646	164	KLT 23 16 4	767 500	53	PHE 3 20 S FU 1P	767 416	158
KFP 25 M16 45 SSM	755 645	63	KLT 101 30 10	767 996	56	PHE3 20 S ZK	767 920	38
KFP 25 M16	755 600	63	KLT 104 9	767 574	56	PHE3 25 S 50 1P	767 125	157
KFP 25 RL 10	725 010	63	KLT 121 25 16	766 601	56	PHE3 30 S	767 730	37
KFP 25 RL 12	725 012	63	KLT 133 34 10	766 996	56	PHE3 30 S ZK	767 930	38
KFP 25 RL 14	725 014	63	KLT 160 17	766 614	164	PHE3 66 16.7S SN7705	769 714	159
KFP 25 RL 16	725 016	63	KLT 247 10 22	766 602	56	PHE3 PK6 20 L SB ZK	767 922	39
KFP 25 RL 18	725 018	63	KLT 247 10 22	766 602	164	PHE3 PK6 20 S SB ZK	767 921	39
KFP 25 RL 20	725 020	63	KM AB M10 SN7280	745 021	88	PHE3 PK10 30 L SB ZK	767 932	39
KFP 25 S AL 12	756 300	63	KR ESH U 1000	785 738	135	PHE3 PK10 30 S SB ZK	767 931	39
KFP 25 W45 M12 45SSM	756 245	64	KS SG BLS 8	766 105	101	PHE3S2 60 110 S	767 980	40
KFP 25 W45 M12	756 200	64	KS SK A NS VP33XYL	VP33XYL	83	PHE3S 20 S ZK	767 724	40
KFP 25 W45 M16 45SSM	756 645	64	KS SK C NS VHNEFQE	VHNEFQE	82	PHE3S60 110S CSN7774	769 712	40
KFP 25 W45 M16	756 600	64	KS SQ A NS VNRLBXU	VNRLBXU	83	PHE3S 110 132 S	767 131	159
KFP 25 W90 M12 45SSM	757 245	64	KS SQ C NS VL2FG28	VL2FG28	82	PHE3 U 3 30 S	767 733	37
KFP 25 W90 M12	757 200	64	KSX SK A MS VANH53Y	VANH53Y	83	PHE3 U 3 30 S ZK	767 960	38
KFP 25 W90 M16 45SSM	757 645	64	KSX SK C MS V5DHK24	V5DHK24	82	PHE3 U 6 36 S SN7728	767 944	38
KFP 25 W90 M16	757 600	64	KSX SQ A MS VSJ3Y6N	VSJ3Y6N	83	PHE4 1 3 S	783 013	34
KK 35 NS	785 647	98	KSX SQ C MS VV7M6CQ	VV7M6CQ	82	PHE4 3.3 11 S	783 233	36
KK 56 41 17 EK HK	745 953	92	KTST SET 6ZFS GBSW 10M KT	700 111	30	PHE4 3.3 S	783 033	36
KK 56 41 17 EK VI TI	745 952	84	KTST SET 6ZFS RTWS 10M KT	700 110	30	PHE4 3 10 S 60	783 332	35
KK 56 41 17 EK VI TI	745 952	86	L71 PS PHE 185	767 766	100	PHE4 3 10 S	783 231	34
KKH 20 D SK	772 330	71	LED APS T AS	785 829	132	PHE4 3 10 S ZK	783 141	35
KKH 20 D SQ	772 331	71	LED HL ESH	785 723	135	PHE4 3 S	783 003	34
KKH 20 FS	772 312	76	LIGHT SB FO E P CI WRU SRC 36	787 220	131	PHE4 3 S ZK	783 103	34
KKH 20 HG	772 313	76	LIGHT SB FO E P CI WRU SRC 37	787 221	131	PHE4 6.6 22 S	783 243	36
KKH 20 SK	772 310	71	LIGHT SB FO E P CI WRU SRC 38	787 222	131	PHE4 6.6 S	783 066	36
KKH 20 SQ	772 311	71	LIGHT SB FO E P CI WRU SRC 39	787 223	131	PHE4 6 20 S 16.7	783 420	157
KKH 20 SQL	772 314	73	LIGHT SB FO E P CI WRU SRC 40	787 224	131	PHE4 6 20 S 60	783 335	35
KKH 25 D SK	772 340	71	LIGHT SB FO E P CI WRU SRC 41	787 225	131	PHE4 6 20 S	783 235	34
KKH 25 D SQ	772 341	71	LIGHT SB FO E P CI WRU SRC 42	787 226	131	PHE4 6 20 S ZK	783 151	35
KKH 25 FS	772 322	76	LIGHT SB FO E P CI WRU SRC 43	787 227	131	PHE4 6 S	783 006	34
KKH 25 HG	772 323	76	LIGHT SB FO E P CI WRU SRC 44	787 228	131	PHE4 6 S ZK	783 106	34
KKH 25 SK	772 320	71	LIGHT SB FO E P CI WRU SRC 45	787 229	131	PHE4 10 20 S	783 240	34
KKH 25 SQ	772 321	71	LIGHT SB FO E P CI WRU SRC 46	787 230	131	PHE4 10 30 S 60	783 345	35
KKH 25 SQL	772 324	73	LIGHT SB FO E P CI WRU SRC 47	787 231	131	PHE4 10 30 S	783 250	34
KKL 92 28 12	766 994	56	LK 4 40 TS SQL	784 352	168	PHE4 10 30 S ZK	783 161	35
KKL 127 28 12	766 995	56	MA DCA HR LRM	767 133	53	PHE4 10 S	783 010	34
KKL DCA	767 107	56	MA DCA LR LRM	767 136	53	PHE4 10 S ZK	783 110	34
KKL EKS VI KVS	745 902	84	MA SDS M12	723 199	172	PHE4 11 33 S	783 255	36
KKL EKS VI KVS	745 902	92	MFB APS	785 724	132	PHE4 11 S	783 011	36
KKL EKV ÜGK MB	745 106	90	MFB APS	785 724	134	PHE4 20 36 S 60	783 342	35
KKL PHE3 60 110	766 998	56	MFB APS	785 724	137	PHE4 20 36 S	783 245	34
KKL PHE3	767 997	56	MO DIGIK AC2	766 483	24	PHE4 20 S	783 020	34
KKL PHE3 L	767 999	56	MO DIGIK AC2	766 483	154	PHE4 20 S ZK	783 120	34
KKL PK PHE3 L	766 036	56	MOMS LORE EUK	799 100	92	PHE4 22 S	783 022	36
KK M8 0 24 SK 10	745 508	88	MZ 1.5 IEC LR6 AL	766 618	99	PHE4 30 60 S	783 270	35
KKS M8 0 24 SK10	745 509	90	MZ 1.5V L91 FR6 LI 4	766 611	99	PHE4 30 S	783 030	34
KK TA 0 24 SK10	745 503	85				PHE4 30 S ZK	783 130	34
KL-A-8-36-S	787 480	129						
KL-A-9-36-S	787 481	129						

Type	Part No.	Page	Type	Part No.	Page	Type	Part No.	Page
PHE4 33 S	783 045	36	PSA ESET L OD	785 904	136	S60 PS PHE 285	767 760	99
PHE4 60 110 S	783 275	35	PSA ESET M ID	785 900	136	S61 PS PHE 435	767 761	99
PHE4 60 132 S	783 280	35	PSA ESET M OD	785 903	136	S62 PS PHE 620	767 762	99
PHE4 110 132 S 16.7 50	783 460	160	PSA ESET S ID	785 906	136	S63 PS PHE 8CK	767 768	100
PHE4 110 220 S	783 285	35	PSA ESET S OD	785 908	136	S63 PS PHE 780	767 763	99
PHE4 220 420 S	783 290	35	PSA ESET XL ID	785 902	136	S64 PS PHE 880	767 764	99
PHE4 U 2 20 S	783 520	34	PSA ESET XL OD	785 905	136	S66 PS PHE 880	767 771	100
PHE4 U 3.3 33 S	783 533	36	PS DCA HR LRM	767 150	52	S66PS PHE880 C SN7771	769 701	100
PHE4 U 3 30 S	783 530	34	PSK 4 30 SQL	784 201	73	S 100 ZK MS	785 329	108
PHE4 U 3 36 S 60	783 395	35	PSK 4 30 SQL EH	784 401	73	SAG DCA A LRM	767 112	51
PHE4 U 6.6 11 S	783 511	36	PSK 10 32 SQL	784 032	73	SAG DCA P HR GA	767 101	50
PHE4 U 6 20 S 16.7 50	783 430	157	PSK 10 32 SQL SB	784 038	73	SAG DCA P LRM GA	767 102	50
PHE4 U 6 36 S	783 536	34	PSK 10 65 SQL	784 301	73	SA KLFP SQ SK	795 212	83
PHE 6 20 S 16.7 1P	767 415	158	PSK 10 65 SQL EH	784 501	73	SAK PFE ARA	792 455	168
PHE 15 16.7 4T TA	766 616	156	PSK 10 85 SQL	784 085	73	SAK PFE ARA AB29	792 456	168
PHE 15 16.7 6T TA	766 617	156	PSK FV 4 30 SQL	784 480	73	SAK PFE KN	792 450	168
PHE 15 16.7 BEL STK	767 413	158	PSO M8 PHE	766 916	54	SAK PFE KN AB29	792 451	168
PHEG1 FD M SN7223	767 614	163	PSO M8 PHE L800	766 960	54	SB ESH U 1000	785 739	135
PHEG1 FD P 3	767 610	163	PSO M8 W25 PHE	766 940	54	SBKL EKS TI KVS 2F	766 298	86
PHEG1 S P SN7240	767 636	44	PSO M8 W45 PHE	766 941	54	SBKL EKS TI KVS 2F	766 298	92
PHEG1 S P SN7240	767 636	162	PSO M8 W90 PHE	766 950	54	SBKL EKS TI KVS	766 300	86
PHEG1.S P SN7401	767 666	44	PSS DII	745 109	90	SBKL EKS TI KVS	766 300	92
PHEG1.S P SN7401	767 666	162	PV DCA PC LRM	767 132	52	SBKL EKS VI KVS	745 900	84
PHEG2 P SN7194	767 637	44	PV DCA PC LRM T	767 139	53	SBKL EKS VI KVS	745 900	92
PHEG2 P SN7194	767 637	163				SCH A10.5 V4A	525 910	66
PHEG2 P SN7259	767 645	44	RBK 25 SQ SN7151	715 314	72	SCH A13 V4A	525 912	66
PHEG2 P SN7259	767 645	163	RBK 26 SQ SN7255	715 315	72	SCH A17 V2A	525 916	66
PHEG2 P SN7346	767 639	163	RBK 30 SQ SN7642	715 313	72	SCS 36 1000	763 610	26
PHEG2 P SN7407	767 640	44	RBK 35 SQ	715 312	72	SCS 36 1500	763 611	26
PHEG2 P SN7407	767 640	163	REB 25055 ZK MS	785 169	108	SCS 36 2000	763 612	26
PHEG2.P SN7517	767 671	44	RED E27 E14 ÜGK MB	745 108	90	SCS 36 STK 1000	763 100	26
PHEG2.P SN7517	767 671	163	RK 230 100 AS25	766 056	155	SCS 72 1500	763 615	26
PHEG2 P SN7552	767 647	44	R KIT APS ... SC	785 828	132	SCS 72 2000	763 620	26
PHEG2 P SN7552	767 647	163	RP 250 115 20	766 057	155	SCS 72 3000	763 630	26
PHG2 6	766 706	39	RSI 32	785 213	108	SCSN 36 STK 1000	763 111	26
PHG2 10	766 710	39	RSI 34	785 214	108	SDS 1	923 110	172
PHG2 20	766 720	39	RSI 35	785 215	108	SDS 2	923 117	172
PHV1P 6 12	759 706	48	RSI 38	785 216	108	SDS 3	923 116	172
PHV1P 10 20	759 712	48	RSI 45	785 217	108	SDS 4	923 118	172
PHV1P 20 36	759 736	48	RSI 51	785 218	108	SDS 5	923 119	172
PHV1P U 5 36	759 716	48	RSI 58	785 219	108	SE E14	785 639	28
PSA ESET 2XL ID	785 907	136	RST 36 1000	766 040	26	SE E18	785 650	28
PSA ESET 2XL OD	785 909	136	RST 36 1500	766 041	26	SE E27 E33	785 640	28
PSA ESET KONFI ID	785 960	136	RST 36 2000	766 042	26	SE NH00	785 641	28
PSA ESET KONFI OD YE	785 961	137	RST 72.5 1500	766 043	26			
PSA ESET L ID	785 901	136						

Type	Part No.	Page	Type	Part No.	Page	Type	Part No.	Page
SE NH0	785 642	28	TFRS MS	785 950	107	WJP HP 13	786 721	141
SE NH1	785 643	28	TG DCA	767 110	50	WJP O 3XL	786 756	140
SE NH2 3	785 644	28	TRS MS	785 100	106	WJP O AP 3XL	786 766	140
SE REG 1TE	785 638	29	TRS MS V1	785 112	106	WJP O AP L	786 763	140
SE REG 2TE	785 652	29	TRS NS	785 502	105	WJP O AP M	786 762	140
SE REG 3TE	785 637	29				WJPO AP S	786 761	140
SET DIGIK AC2	766 480	24	UEK 25 FS	774 034	75	WJP O AP XL	786 764	140
SET DIGIK AC2	766 480	154	UEK 25 HG	774 234	76	WJP O AP XXL	786 765	140
SKL 95 21 10	767 701	56	UEK 25 SKN	774 434	76	WJP O B 3XL	786 716	142
SKS M10X30 V2A	561 924	66	UEK 30 FS	774 130	75	WJP O B L	786 713	142
SKS M12X25 V2A	561 925	66	UEK 30 HG	774 330	76	WJP O B M	786 712	142
SKS M12X30 V2A	561 930	66	UEK 30 SKN	774 530	76	WJPO B S	786 711	142
SKS M12X35 V2A	561 935	66	UK 25 SK	773 034	71	WJP O B XL	786 714	142
SKS M16X30 V2A	561 931	66	UK 25 SQ	773 234	71	WJP O B XXL	786 715	142
SPBCLPS	782 097	148	UK 25 SQL	773 236	74	WJP OC 3XL	786 746	140
SPG DCA IT LRM	767 122	51	UK 30 SK	773 130	71	WJP OC L	786 743	140
SPN 500B	766 660	45	UK 30 SQ	773 330	71	WJP OC M	786 742	140
SPN 1000 A	700 100	46	UK 30 SQL	773 331	74	WJP OC S	786 741	140
SPN 1000B	766 665	45	UK K25 FL30 HG	774 251	168	WJP OC XL	786 744	140
SPN 1200 D	700 102	46	UK K25 FL30 SQL	773 251	168	WJP OC XXL	786 745	140
SRH 1180 IS 650 MS	785 119	108				WJPO H	786 770	140
SSK 36 STK 560	766 164	23	VH FS APS T AS	785 827	132	WJP O L	786 753	140
SSK 36 STK 560	766 164	100	VH SC APS T AS	785 820	132	WJP O LP 3XL	786 786	140
SSK 36 STK 930SN7689	766 169	100	VL HOEL 20 500	785 398	109	WJP O LP L	786 783	140
SSK M12	765 005	22	VPG90	787 000	129	WJP O LP M	786 782	140
SSK M12	765 005	100	VPG90	787 000	130	WJP O LP S	786 781	140
SSK SQ	765 009	23	VS 500 SPN II	766 542	45	WJP O LP XL	786 784	140
SSK SQ	765 009	100				WJP O LP XXL	786 785	140
STB 80 ZK MS	785 159	108	WBN 200 2,5M NS	785 646	97	WJP O M	786 752	140
STT 55 27 30	785 111	92	WHS AS BSZFUV	700 059	30	WJPO S	786 751	140
STT 55 27 30	785 111	108	WHS AS SV	700 058	30	WJP O XL	786 754	140
STT 55 27 30	785 111	166	WHS AS ZFUV	700 060	30	WJP O XXL	786 755	140
STT 110 15	769 509	167	WJP FP 39 40	786 722	141			
STT 120 30 15	766 704	164	WJP FP 41 42	786 723	141	ZK55 IS	771 230	89
STT 180 20	766 039	101	WJP FP 43 44	786 724	141	ZK55 IS BL	771 231	89
SZ HH 1060	765 040	27	WJP FP 45 46	786 725	141	ZK85 BS	771 232	89
SZ HH 1250	765 041	27	WJP HFP SET	786 726	142	ZK85 BS BL	771 233	89
SZ HH 1500	765 042	27	WJP HP 9	786 717	141			
SZ HH W20 1070	765 050	27	WJP HP 10	786 718	141			
SZ HH W20 1250	765 051	27	WJP HP 11	786 719	141			
SZ HH W20 1500	765 052	27	WJP HP 12	786 720	141			

All specifications and recommendations in this catalogue on the possible applications of our products should be regarded as product information and for advisory purposes only and are based on our experience and expertise and are given to the best of our knowledge. We do not accept any liability in this respect. This particularly applies to the different conditions of use which are beyond our control. We recommend to check whether the respective DEHN product is suitable for the intended application. Application, use and processing of our products are beyond our control. Therefore, the product is completely subject to the user's responsibility.

Illustrations are not binding.

We accept no liability for misprints, modifications and errors.

General Terms and Conditions

Our „General Terms and Conditions“ for deliveries and services apply in the most current version available at www.dehn-international.com

* GTIN (EAN-Code)

In the catalogue, you will find the GTIN (EAN code) next to the Part No. For reasons of clarity, only the individual GTIN part is specified. The country and DEHN code (40 13364) must be put in front of this number.

¹⁾The country and DEHN code (69 42299) must be put in front of this number.

Abbreviations:

PG	Product Group
PU	Packing Unit
SU	Sales Unit (piece, meter, millimeter, kilogram, grams, liter, kit or pair)
pc(s)	Piece
m	Meter
mm	Millimeter
kg	Kilogram
g	Grams
Ltr	Liter
Pa	Pair
Pak	Kit
Weight	Weight per sales unit

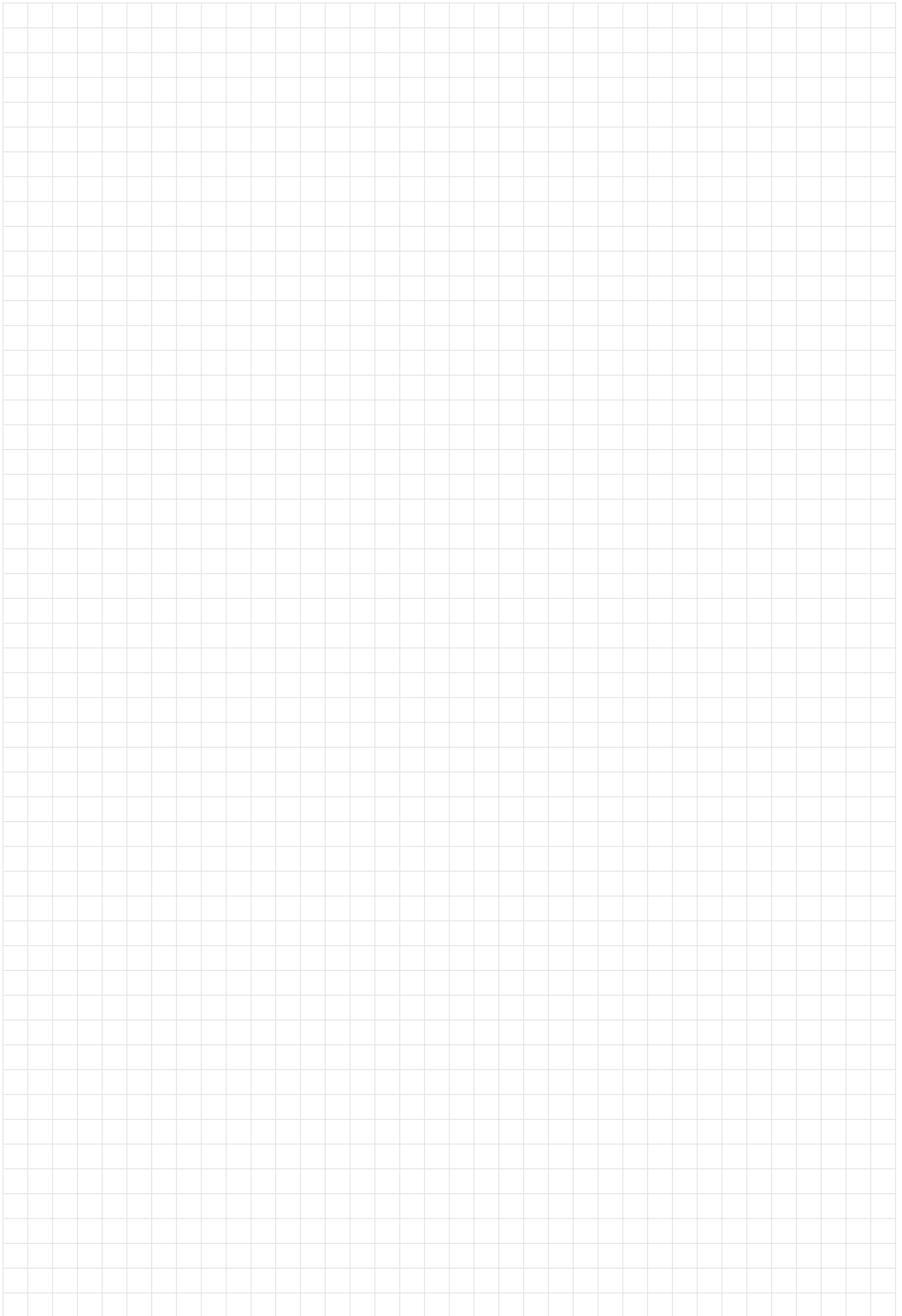

Product	Page	Product	Page	Product	Page
Accessory for NS and MS Cleaning Kits Adapter	108	Earthing and Short-Circuiting Devices for Railway Applications	169	Phase Connecting Elements for Switchgear Installations	70
Adapters and End Fittings	55	Earthing Handle for Low-Voltage Installations	91	PHE III Voltage Detector	37
Arc Fault Protection System	145	Earthing Kit	74	PHE III Voltage Detector *	157
Artificial Leather Bag	56 / 164	Earthing Spike	75	PHE III Voltage Detector Kit	40
ASP Non-Contact Voltage Detector Kit	41	Earthing Sticks for Overhead Lines	78	PHE III Voltage Detector Kit *	159
ASP Non-Contact Voltage Detector Kit *	160	Earthing Sticks for Railway Applications	167	PHE III ZK Indicator with Test Prod	38
Balaclava	133	Earthing Sticks for Switchgear Installations	77	PHE Voltage Detector *	158
Barrier and Accessories	29	EaS Configurator: Easy online configuration	79	PHE Voltage Detector Kit *	156
Canvas Bag	92 / 164	EaS Devices (fully insulated) for Low-Voltage Cable Distribution Cabinets	84	PHE/G DC Voltage Detector	44
Chain post set	30	EaS Devices (partly insulated) for Low-Voltage Cable Distribution Cabinets	86	PHE/G DC Voltage Detector *	162
DEHN - Informative	5	Electrodes	54	PHE4 Voltage Detector	36
DEHNcap HR-LRM Test Kit	52	E-mobility warning signs	30	(British Influenced Voltage Level)	36
DEHNcap Test Adapter	53	ESH U S Safety Helmet for Electricians	135	PHE4 Voltage Detector High Voltage	35
DEHNcap/A Voltage Indicator	51	Extensions	102	PHE4 Voltage Detector High Voltage *	160
DEHNcap/IT Interface Test Unit	51	Fastening Material	66	PHE4 Voltage Detector Medium Voltage	34
DEHNcap/P Voltage Indicator	50	Fixed Ball Points	63	PHE4 Voltage Detector Medium Voltage *	157
DEHNcap/PC-LRM Phase Comparator	52	Fixed Ball Points *	164	PHG II Voltage Detector	39
DEHNcare - Personal Protective Equipment - Size charts	143	Fixed Earthing Points	65	Plastic Bag / Rucksack	137
DEHNcare APG	128	FRS ZK MS Damp Cleaning Kit	105	Plastic Bag / Rucksack	137
DEHNcare APG XT	126	Hand Oiler for Switchgear Installations	109	Plastic Case	56 / 92
DEHNcare APHO	134	Handle	102	PRACTICAL Additional Information	8
DEHNcare APS with Active Protection	132	HSA 194 High-Voltage Indicator	42	Quenching Device QD II	149
DEHNcare APS with headgear	133	HSA 194 High-Voltage Indicator *	161	Reliable protection when working with high-pressure water jets up to 1000 bar	139
DEHNcare APS with Lever	134	HSA 205 High-Voltage Indicator	43	RST Rescue Rods	26
DEHNcare ArcClassic	125	Ice Removal Rod	154	Safe working on electric railways	151
DEHNcare ArcFit HLP 63 / 124	114	Insulated mats 1,000 V and 36 kV	96	Safety shoes with insulating soles up to 1,000 V	131
DEHNcare ArcFit Indoor	117	Insulating blankets up to 1,000 V	97	SCS Switching Sticks	26
DEHNcare ArcFit Outdoor	117	Insulating caps up to 1,000 V	98	Services	9
DEHNcare PPE sets - Indoor and Outdoor	136	Insulating Elements	102	Sheet Steel Case	56 / 92
DEHNcare UnderWear	123	Insulating Elements	102	Short-Circuiting Bar	82
DEHNcare WJP Head Protection Set	142	Insulating gloves up to 1,000 V	128	Single-pole PHV I Phase Comparator	48
DEHNcare WJP Protective Gloves	141	Insulating gloves up to 36 kV	130	Spare Parts	99
DEHNcare WJP Protective Overall „Advanced“	140	Insulating mats with dielectric strength 50 kV	97	STANDARDS	5
DEHNcare WJP Protective Overall „Basic“	142	Insulating Protective Shutters	93	Storage Devices	55 / 91
DEHNcare WJP Protective Socks	141	Insulating Stick Kit for Cleaning the Windscreens of Electric Locomotives	155	SZ Fuse Tongs	27
DEHNproX - Safe working on electrical installations	19	Insulating Stick with Crank Handle	28	Test Probes	54
DEHNshort - Active Arc Fault Protection System	147	Insulating Sticks	101	Test Prods	99
DEHNshort - Arc Fault Protection System	145	IS Insulating Sticks	22	Test unit for DEHNcap/P	50
Design of Phase Comparators	47	Kits for Railway Applications	165	TFRS MS Combined Cleaning Kit	107
Design of Voltage Detectors	33	Line Clamp	168	TRS MS Dry Cleaning Kit	106
Discharge and Equipotential Bonding Devices	57	Live working	103	TRS NS Dry Cleaning Kit	105
Earth Connecting Elements for Railway Applications	168	Lock-Out Systems	28	Two-pole SPN voltage detector for power supply	45
Earth Connecting Elements for Switchgear Installations and Overhead Lines	75	MicroΩmeter LoRe EaS	92	Two-pole SPN voltage detector for the electrical trade and industry	46
Earth Connecting Plates	67	Operating Heads	100	Universal Clamp	71, 74, 75, 76
Earth Connecting Plates *	165	Personal Protective Equipment	111	Voltage Limiting Devices	171
Earthing and Short-Circuiting Device for Street Lighting Systems	90	Personal Protective Equipment against High-pressure Water Jets	138	Wireless Inspection Camera	24 / 154
Earthing and Short-Circuiting Devices	60	Phase Connecting Elements for Overhead Lines	72		
Earthing and Short-Circuiting Devices (unequipped)	67	Phase Connecting Elements for Railway Applications	168		
Earthing and Short-Circuiting Devices for Crane Conductor Bars	89				

* Railway chapter

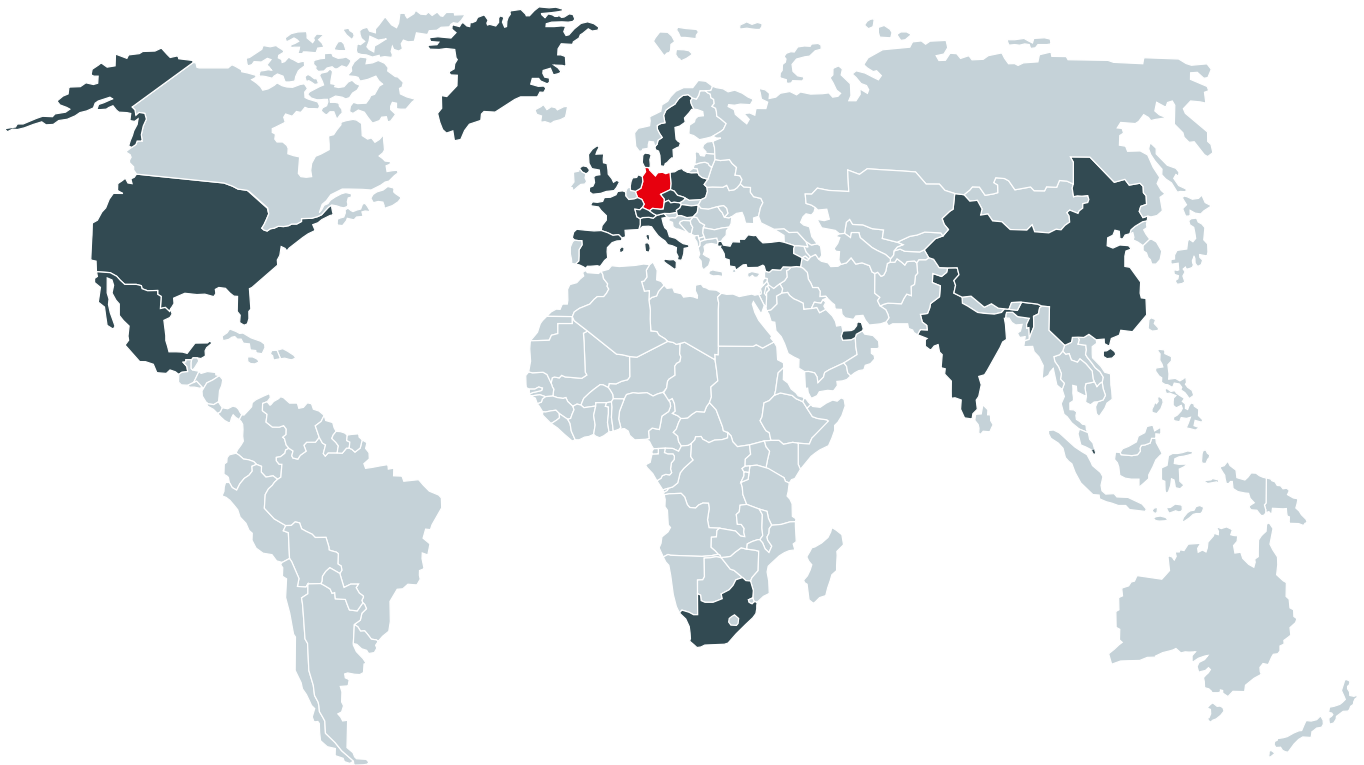

DEHN SE		
Customer Service Center	Commercial customer service	Technical Support
	sales@dehn.de	itss@dehn.de
	Phone +49 9181 906-1547	Phone +49 9181 906-1774
	Fax +49 9181 906-1444	Fax +49 9181 906-1444

Subsidiaries and Representative Offices		
Austria:	DEHN AUSTRIA GmbH	www.dehn.at
China:	DEHN Surge Protection (Shanghai) Co. Ltd.	www.dehn.cn
Czech Republic:	DEHN s.r.o.	www.dehn.cz
Denmark:	DESITEK A/S	www.desitek.dk
France:	DEHN FRANCE S.à.r.l.	www.dehn.fr
Great Britain:	DEHN (U.K.) LTD.	www.dehn.co.uk
Hungary:	DEHN office Budapest	www.dehn.hu
India:	DEHN INDIA Pvt. Ltd.	www.dehn.in
Italy:	DEHN ITALIA S.p.A.	www.dehn.it
Mexico:	DEHN PROTECTION MÉXICO, S.A. de C.V.	www.dehn.mx
Netherlands:	DEHN NEDERLAND B.V.	www.dehn.nl
Poland:	DEHN POLSKA Sp. z o.o.	www.dehn.pl
Singapore:	DEHN (SEA) PTE. LTD.	www.dehn.sg
South Africa:	DEHN AFRICA (Pty) Ltd.	www.dehn-africa.com
Spain:	DEHN IBÉRICA Protecciones Eléctricas, S.A. Unipersonal	www.dehn.es
Sweden:	DEHN SVERIGE AB	www.dehnab.se
Switzerland:	ELVATEC AG	www.elvatec.ch
Turkey:	DEHN office Istanbul	www.dehn.com.tr
United Arab Emirates:	DEHN MIDDLE EAST FZE	www.dehn.ae
USA:	DEHN Inc.	www.dehn-usa.com

Sales activities in more than 70 countries worldwide	
You can find your current local contact person online at:	http://www.dehn-international.com/en/contact



www.dehn-international.com

Surge Protection
Lightning Protection / Earthing
Safety Equipment

DEHN SE
Hans-Dehn-Straße 1
92318 Neumarkt
Germany

Phone +49 9181 906-0
info@dehn.de



Technical changes, misprints and errors are reserved. The illustrations are non-binding.

DS405/EN/1023
© Copyright 2023 DEHN SE

DEHN protects.
www.dehn-international.com

